

1

10 x 10 cm

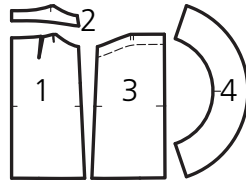

A

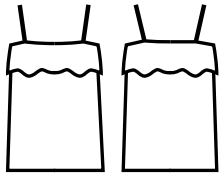
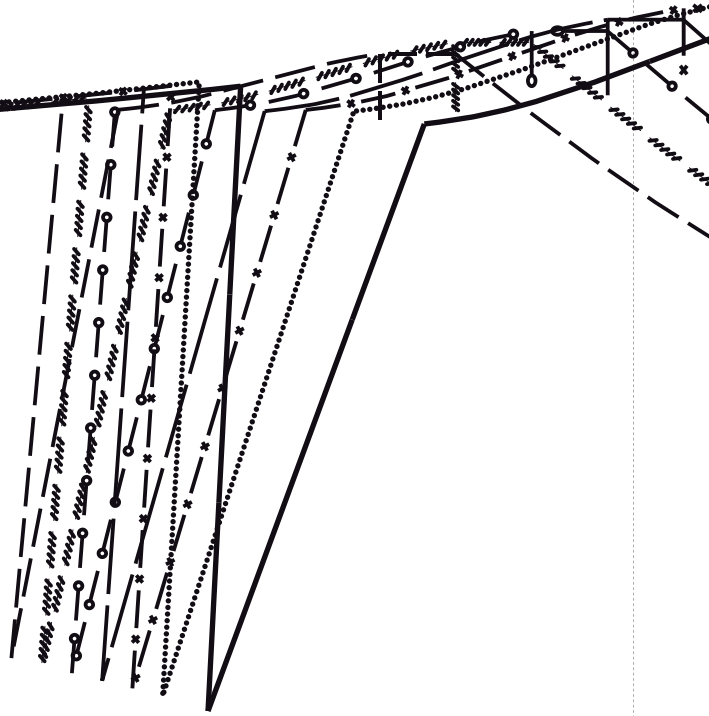
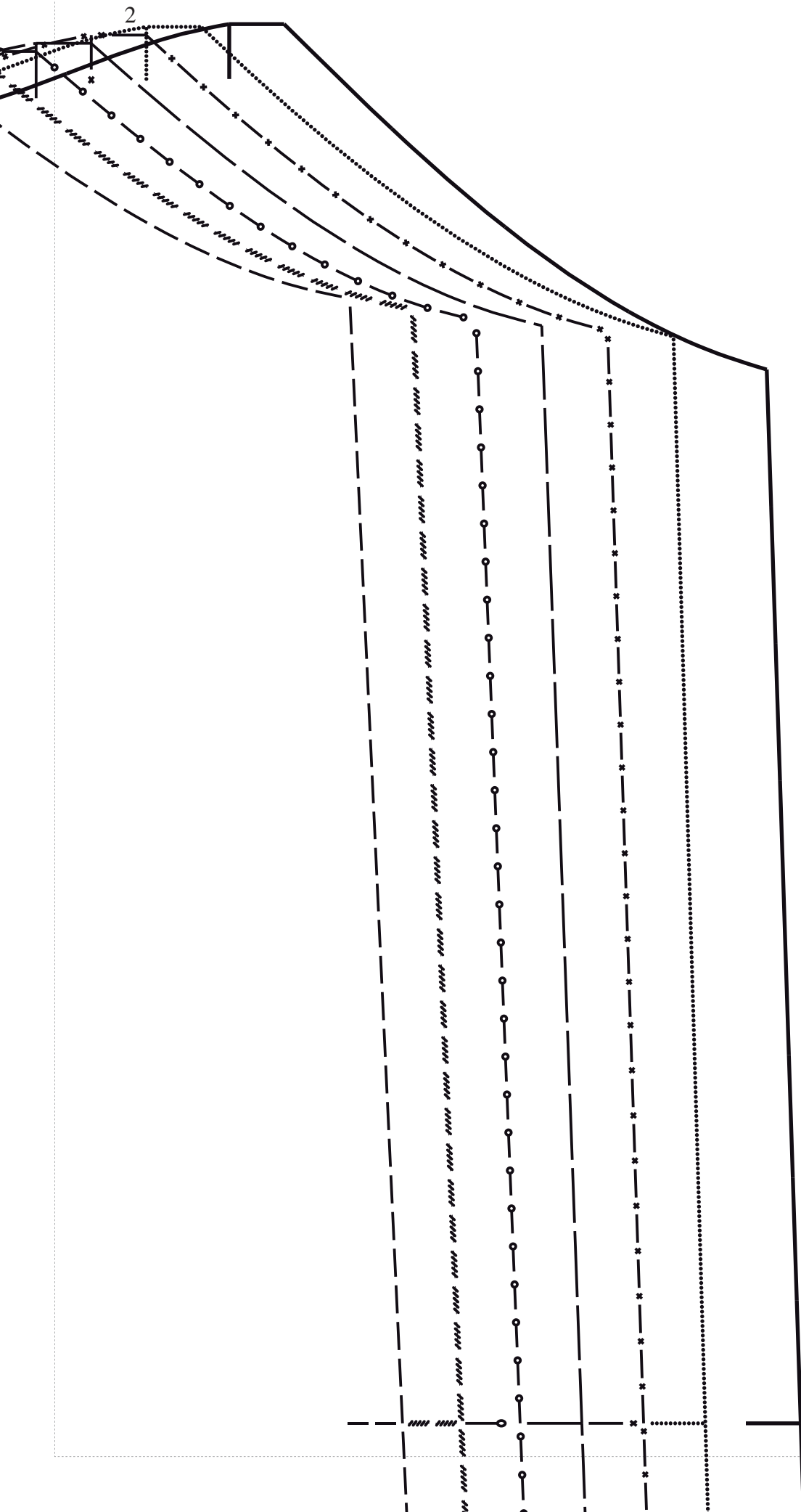

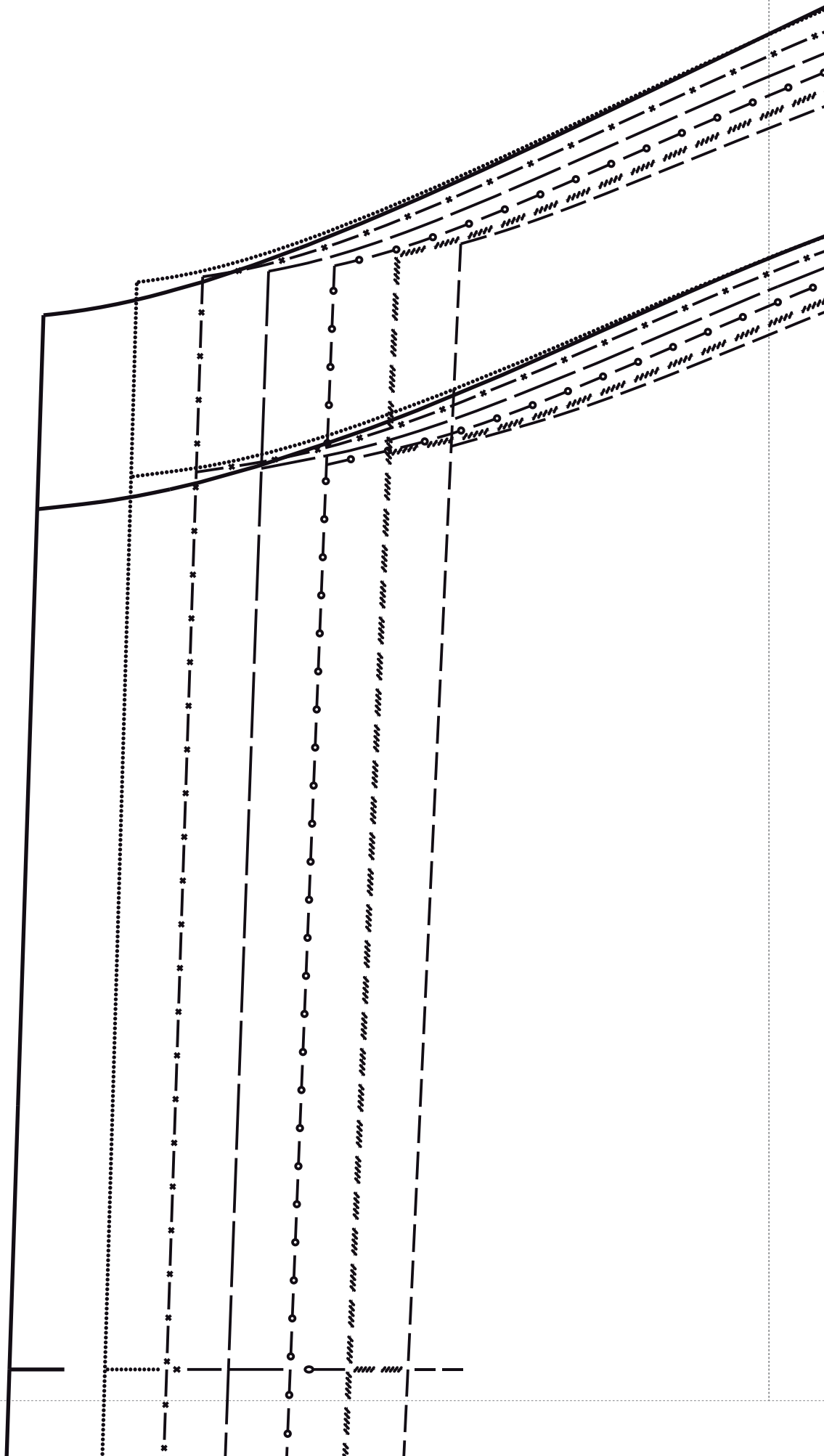

4

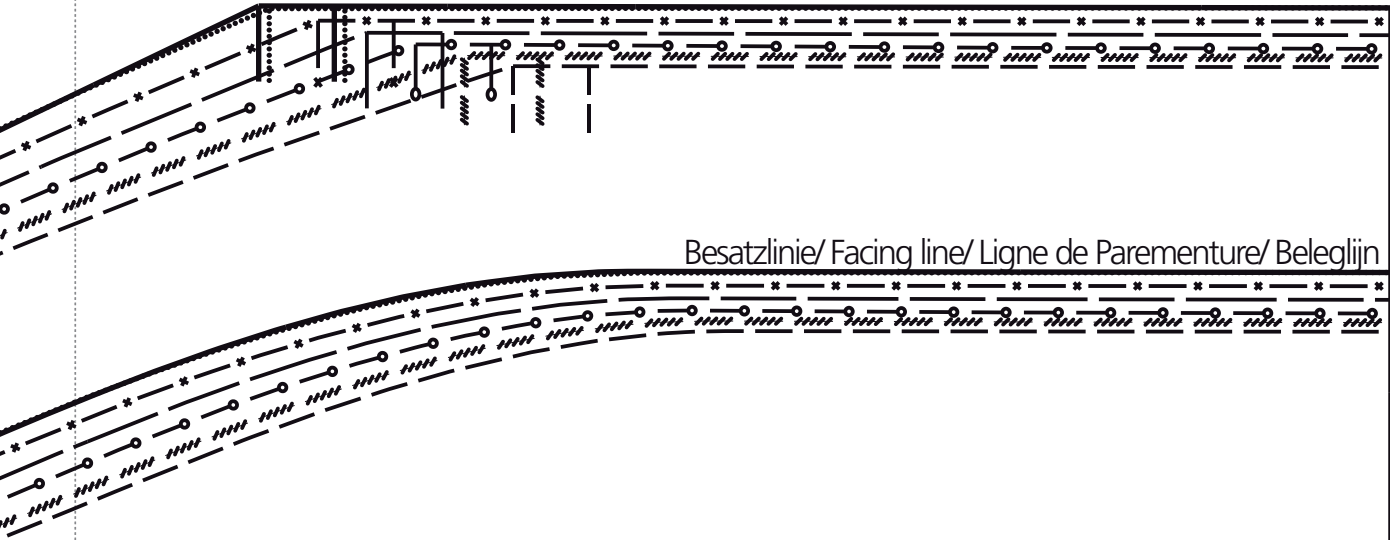

Besatzlinie/ Facing line/ Ligne de Parementure/ Beleglijn

Rückwärtige Mitte Stoffbruch Fadenlauf / Centre back fold straight grain/
Milieu envers pli droit fil/ Middenachter stofvouw Draadrichting

Vordere Mitte Stoffbruch Fadenlauf/ Centre front fold straight grain/ Milieu endroit pli droit fil/ Middenvoor stofvouw draadrichting

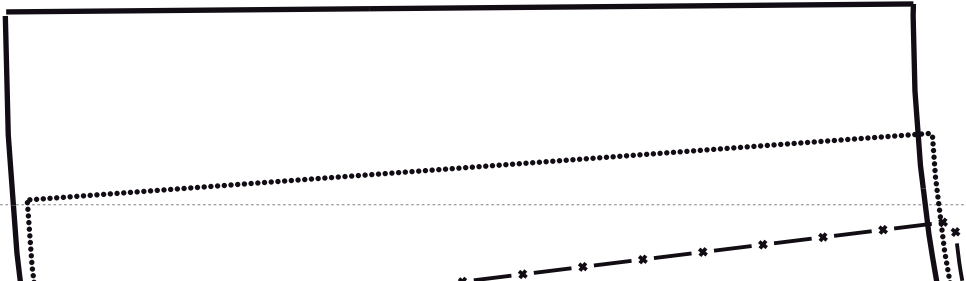

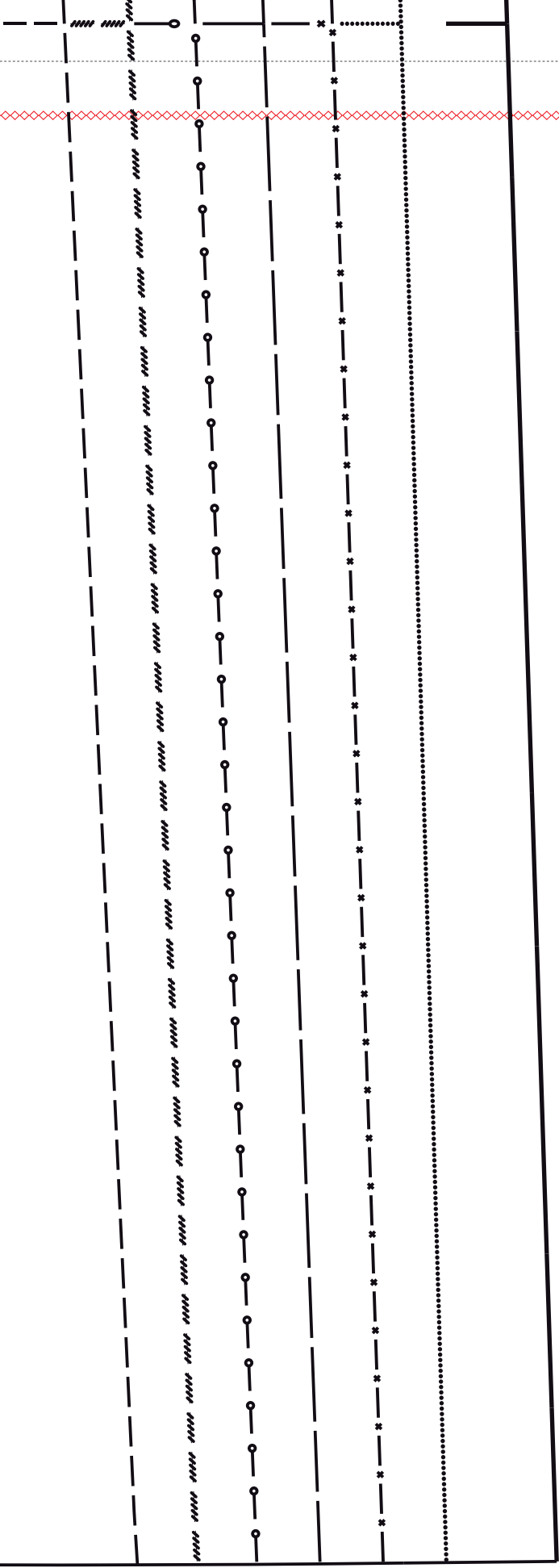

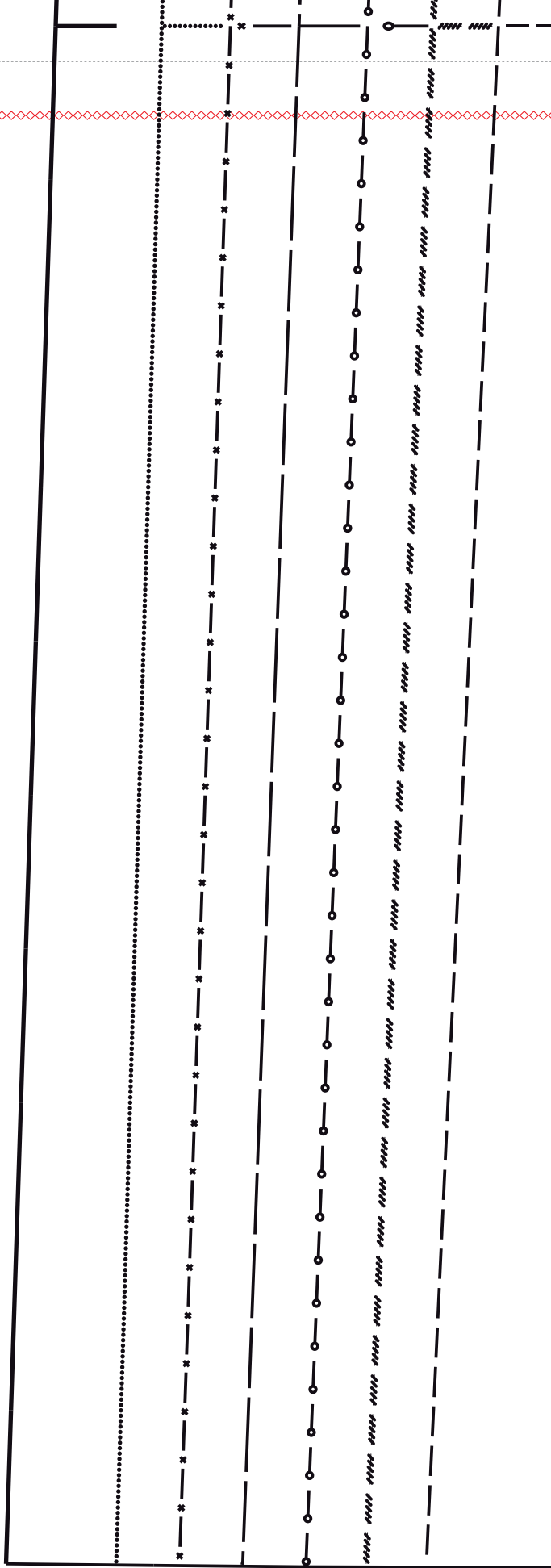

Stof

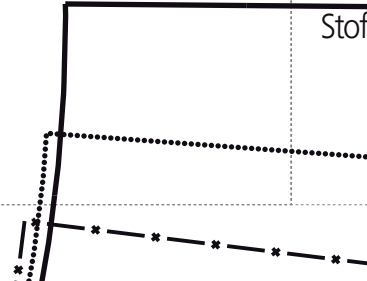

Stoffbruch / Fold/ Pli / Stofvouw

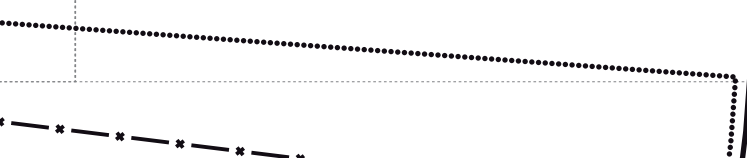

9

made to create

BERNINA

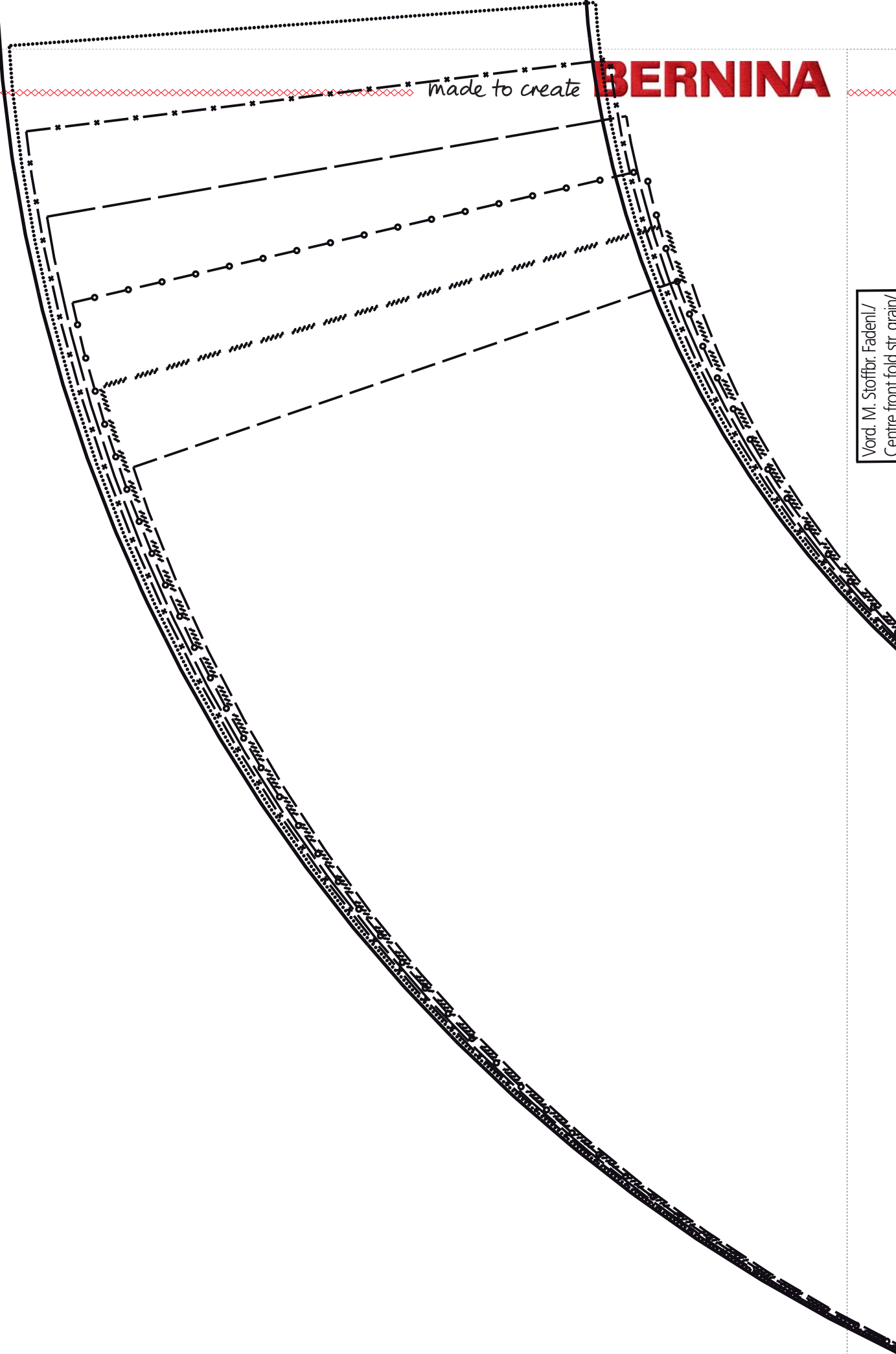

Vord. M. Stoffbr. Fadenl./
Centre front fold str. grain/

Vord. M. Stoffbr. Faden./
 Centre front fold str. grain/
 Milieu endroit pli droit fil/
 Middenv. stofv. draadr.

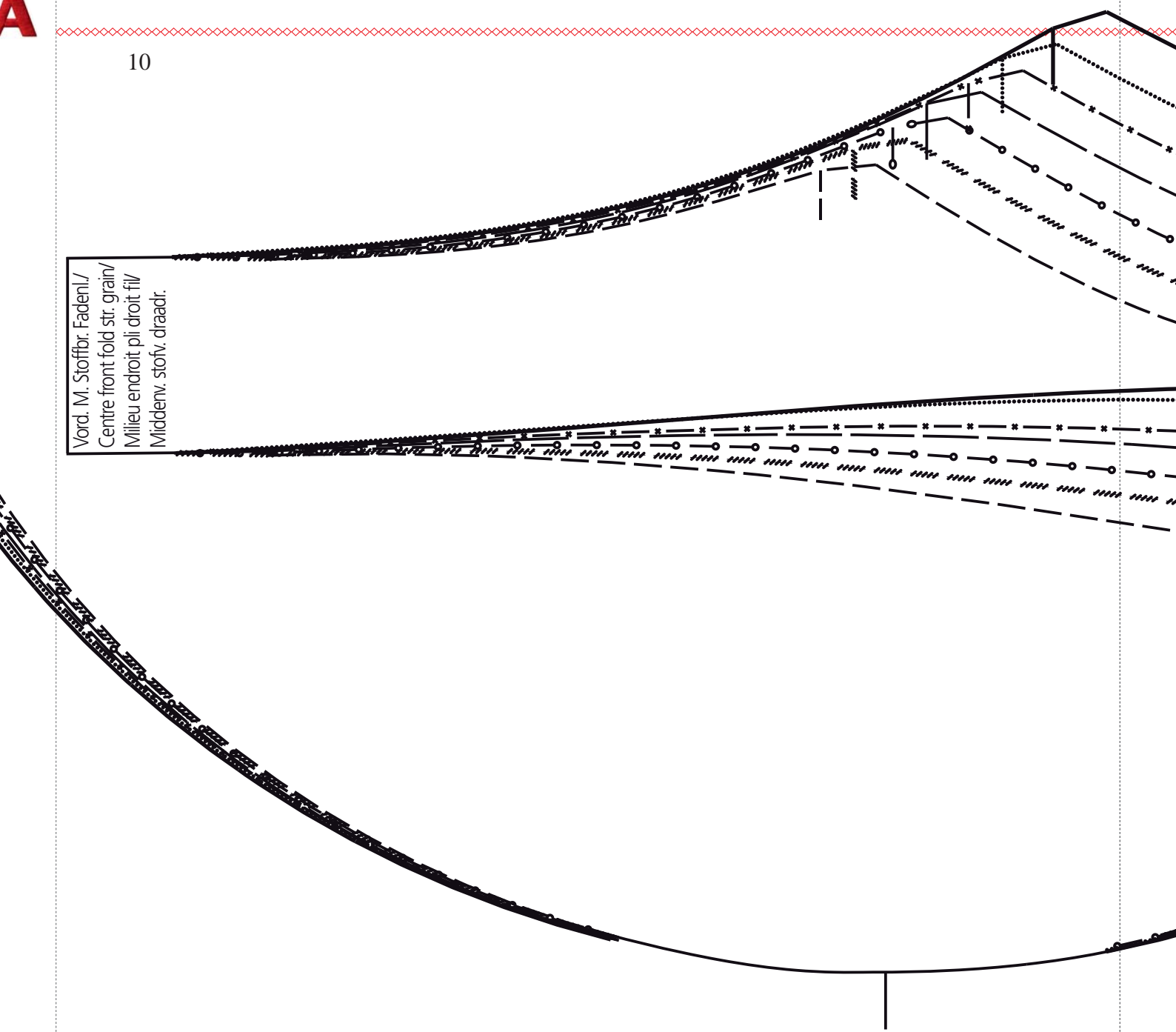

2 x

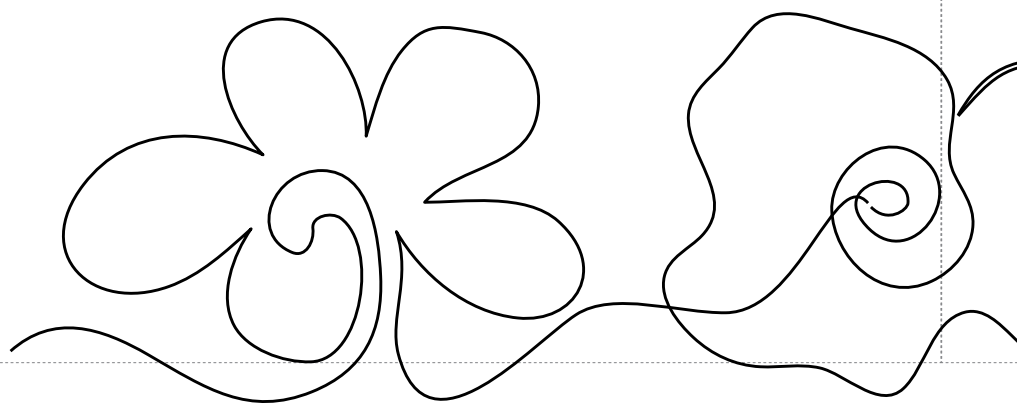

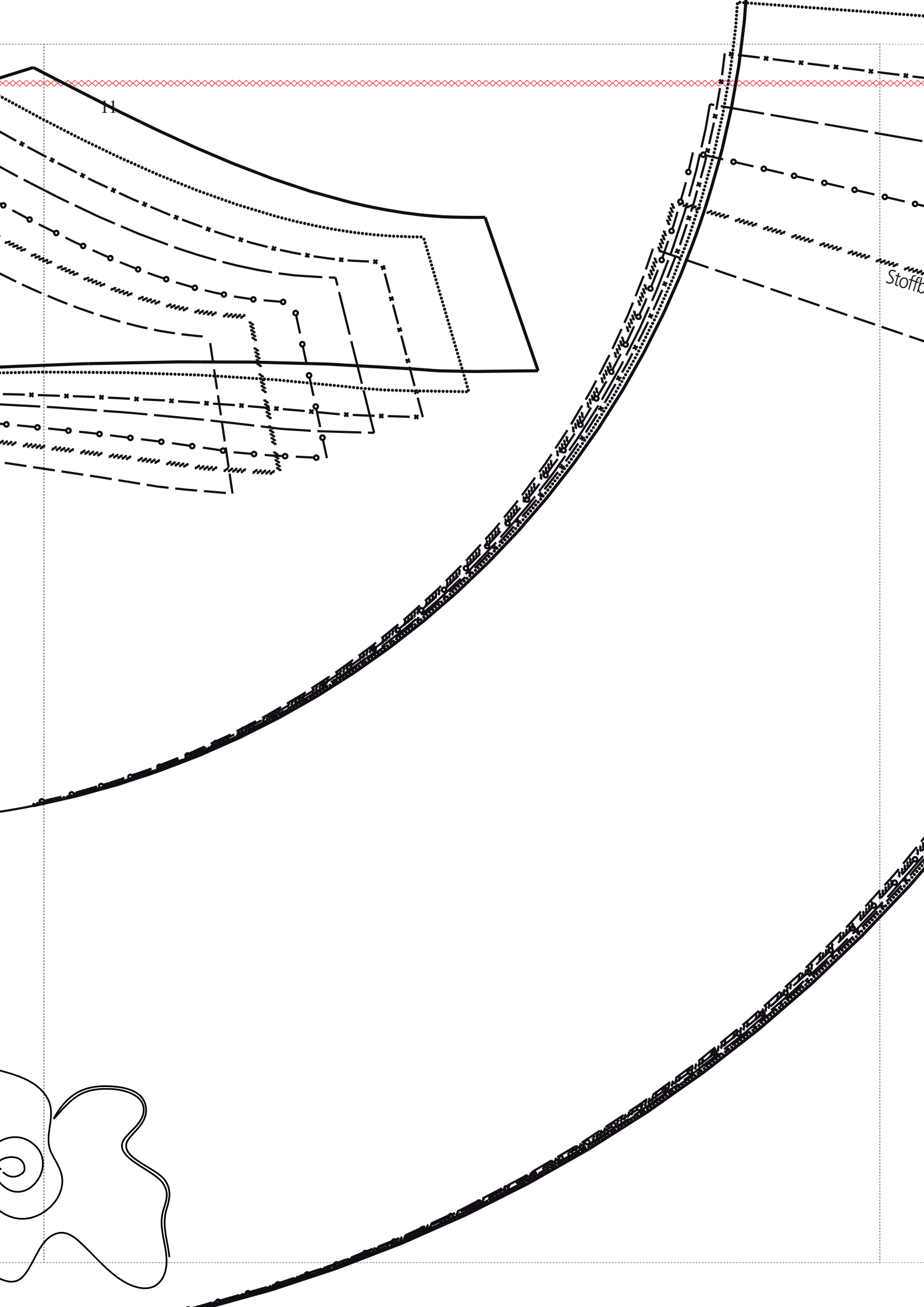

11

Stoff

12

Stoffbruch / Fold / Pli / Stofvouw

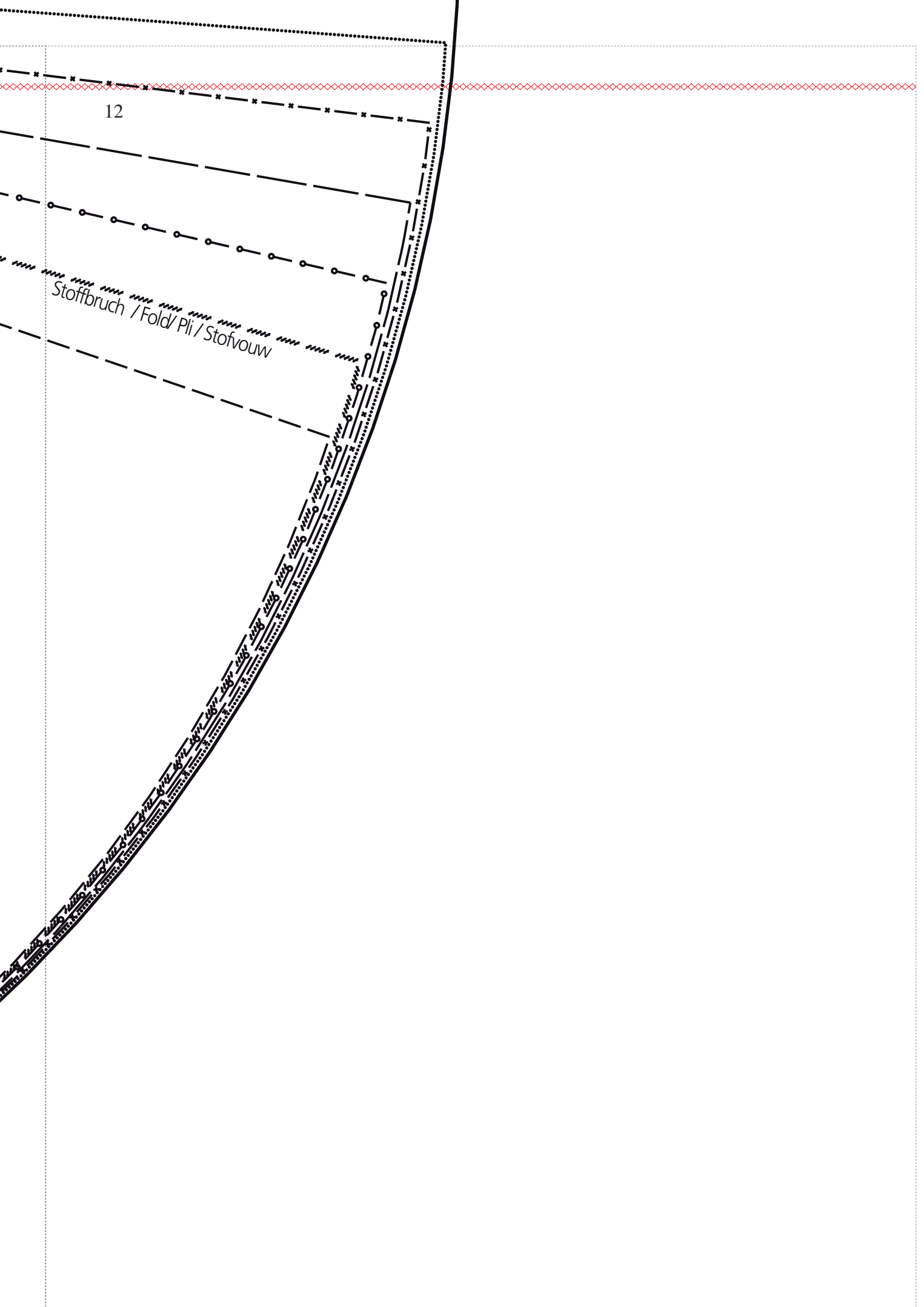

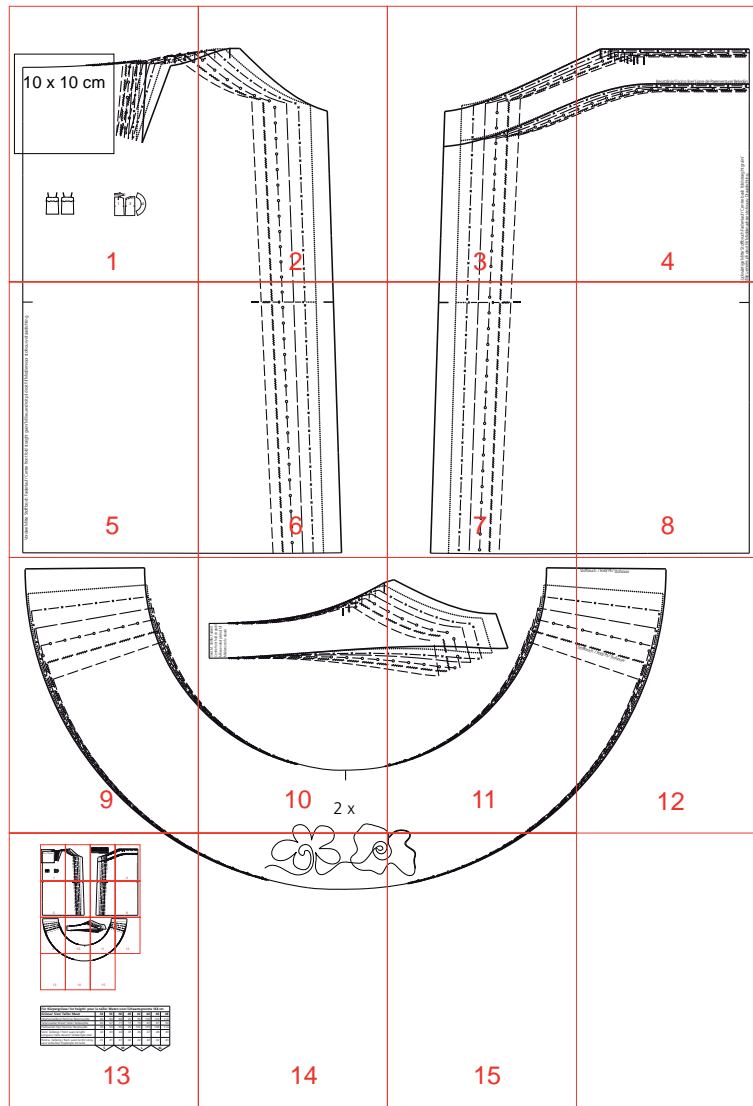

Für Körpergröße/ for height/ pour la taille/ Maten voor lichaamsgrootte 168 cm								
Größe/ Size/ Taille/ Maat	34	36	38	40	42	44	46	48
Oberweite/Bust/ Poitrine/ Bovenwijdte	80	84	88	92	96	100	104	110
Tailenweite/ Waist/ Taille/ Taillewijdte	64	67	71	75	79	83	87	94
Hüftweite/ Hip/ Hanche/ Heupwijdte	90	93	96	99	102	105	108	114
Vord. Tailleng./ Front waist length/ Longueur taille devant/ Taillelengte voor	42	43	44	45	46	47	48	49
Rückw. Tailleng./ Back waist length/ Longueur taille dos/ Ruglengte tot taille	41	41	41	42	42	42	42	43
	S		M		L		XL	

Keine Ausgabe mehr versäumen! Never miss another issue !



**Im Abonnement erhalten Sie garantiert alle Ausgaben,
und das viermal im Jahr.**

With a subscription you can be sure of receiving all 4 issues per year.

► ICH ABONNIERE DIE INSPIRATION FÜR 1 JAHR (4 AUSGABEN)

► I'D LIKE A YEAR'S SUBSCRIPTION TO INSPIRATION (4 ISSUES)

Land - Country

- Schweiz - Switzerland CHF 29
 Europa - Europe EUR 24
 Übersee - Overseas USD 43 / AUD 59

alle Preise inkl. MwSt. und Porto - All prices inclusive of VAT and postage

Sprache - Language

- Deutsch - German
 Englisch - English
 Französisch - French
 Niederländisch - Dutch

Name

Geburtsjahr - Year of birth

Strasse, Nr. - Street, no.

PLZ, Ort- Postal code, town

Telefon/Mail - Phone/Mail

Mein Abonnement beginnt mit der jeweils nächsten Ausgabe.

Es läuft nach Erhalt von 4 Heften automatisch weiter, sofern ich nicht rechtzeitig vor Ablauf kündige.

Subscriptions normally begin with the next issue. Subscriptions are automatically renewed after 4 issues if not cancelled in time before their expiry.

**BERNINA International AG, Redaktion Inspiration, CH-8266 Steckborn
 Fax +41 52 762 13 12, E-Mail: inspiration@bernina.com**

