

BERNINA Accessories

Solutions for your ideas

BERNINA accessories at a glance

BERNINA offers a wide range of sewing, embroidery and quilting accessories. In this brochure you'll find the right tools for all your sewing and embroidery projects.



made to create

BERNINA

Category A

1	910	1001	1020	1091	2	1630
	930	1004	1021	1120		
	931	1005	1030	1130		
	932	1006	1031	1230		
	933	1008	1050	1240		
	940	1010	1070	1241		
	950	1011	1080	1260		
	1000	1015	1090	1530		



Category B

1	125	220	2	130	3	165	5	B 530
	125 S	230		140		170		B 550 QE
	135	230 PE		150		4		430
	135 S	240		153				440 QE
	145	B 330		153 QE				B 555
	145 S	B 350 PE		155				B 570 QE
	210	B 380		160				630
	B 215			163				



Category C

1	180	3	435
	185		450
2	200		B 560
	730		B 580
			640



Category D

1	B 710
2	B 750 QE
	B 780



Category E

7 Series	Ea¹ B 700 E	5 Series	Eb¹ B 500 E
	Ea² B 720		Eb² B 535
	Ea³ B 740		Eb³ B 540
	Ea⁴ B 770 QE B 790 B 790PLUS		Eb⁴ B 570 QE B 590



Category F

1	B 820 QE
2	B 830
	B 880
	B 880PLUS



Category	Model	Stitch width 0mm	Stitch width 5.5mm	Stitch width 9mm	CB-hook machines	Rotary-hook machines	Rotary-hook machines (RL95)	Rotary-hook machines (RH W 107)	B9-hook machines (RH W 107 XL)	BERNINA-hook machines	Presser-foot pressure	BERNINA Dual Feed system	Sideways motion	PunchWork tool for CB-hook machines (CB)	PunchWork tool for rotary-, B9- and BERNINA-hook machines	Embroidery	DesignWorks	BERNINA Toolbox
Category A																		
A1	1008		✓		✓													
Category B																		
B1	B 215		✓		✓									✓				
	B 330		✓		✓									✓				
	B 350 PE		✓		✓									✓				
	B 380		✓		✓									✓				
B4	B 555		✓		✓					m		✓		✓		✓	✓	✓
	B 570		✓		✓					m		✓		✓		✓	✓	✓
B5	B 530		✓		✓					m		✓		✓				
	B 550 QE		✓		✓					m		✓		✓				
Category C																		
C3	B 560			✓		✓				m		✓		✓	✓	✓	✓	✓
	B 580			✓		✓				m		✓		✓	✓	✓	✓	✓
Category D																		
D1	B 710			✓				✓		e	✓	✓		✓				
D2	B 750 QE			✓				✓		e	✓	✓		✓	✓	✓	✓	✓
	B 780			✓				✓		e	✓	✓	✓	✓	✓	✓	✓	✓
Category E																		
Ea	1 B 700 E	✓							✓					✓	✓	✓	✓	✓
	2 B 720		✓						✓	e		✓			✓	✓	✓	✓
	3 B 740			✓					✓	e	✓	✓		✓				
	4 B 770 QE			✓					✓	e	✓	✓		✓	✓	✓	✓	✓
	4 B 790			✓					✓	e	✓	✓	✓	✓	✓	✓	✓	✓
	4 B 790PLUS			✓					✓	e	✓	✓	✓	✓	✓	✓	✓	✓
Eb	1 B 500 E	✓							✓					✓	✓	✓	✓	✓
	2 B 535		✓						✓	m		✓			✓	✓	✓	✓
	3 B 540			✓					✓	m		✓		✓	✓	✓	✓	✓
	4 B 570 QE			✓					✓	e	✓	✓		✓	✓	✓	✓	✓
	4 B 590			✓					✓	e	✓	✓		✓	✓	✓	✓	✓
Category F																		
F1	B 820 QE			✓				✓		e	✓	✓		✓				
F2	B 830			✓				✓		e	✓	✓	✓	✓	✓	✓	✓	✓
	B 880			✓				✓		e	✓	✓	✓	✓	✓	✓	✓	✓
	B 880PLUS			✓				✓		e	✓	✓	✓	✓	✓	✓	✓	✓

m = manual, e = electronic

Number	Presser-Foot Type	Page	Number	Presser-Foot Type	Page
0	Zigzag foot with finger guard # 99	11	53	Straight-stitch foot with non-stick sole	13
1/1C/1D	Reverse-pattern foot	11	54	Zipper foot with non-stick sole	16
2/2A	Overlock foot	15	55	Leather roller foot	28
3/3C	Buttonhole foot	14	56	Open embroidery foot with non-stick sole	22
3A/3B/3C	Buttonhole foot with slide	14	57/57D	Patchwork foot with guide	30
4/4D	Zipper foot	16	59C	Double-cord foot 4–6mm	29
5	Blindstitch foot	18	60C	Double-cord foot 7–8mm	29
6	Embroidery foot	22	61	Zigzag hemmer 2mm	19
7	Tailor-tack foot	23	62	Straight-stitch hemmer 2mm	19
8/8D	Jeans foot	18	63	Zigzag hemmer 3mm	19
9	Darning foot	31	64	Straight-stitch hemmer 4mm	19
10/10C/10D	Edgestitch foot	18	66	Zigzag hemmer 6mm	19
11	Cordonnet foot	24	68	Roll- and shell hemmer 2mm	19
12/12C	Bulky overlock foot	15	69	Roll- and shell hemmer 4mm	19
14/14D	Zipper foot with guide	16	70	Lap-seam foot 4mm	20
15	Embroidery foot	29	71	Lap-seam foot 8mm	20
16	Gathering foot	23	72	Adjustable ruler foot	32
18	Button-sew-on foot	14	75	Standard adapter shank	37
20/20C/20D	Open embroidery foot	22	77	Short adapter shank	37
21	Braiding foot	24	78	Snap-on shank	37
22	Cording foot with 3 grooves	24	82	Eyelet embroidery attachment	41
23	Appliqué foot	25	83	Circular embroidery attachment	41
24	Free-motion embroidery foot	31	86	Ruffler	23
25	Cording foot with 5 grooves	24	87	Binder attachment for pre-folded bias tape	21
26	Drop-shaped embroidery foot	29	88	Binder attachment for unfolded bias tape	21
29/29C	Quilting foot	31	92	Presser foot for eyelet embroidery	41
30	Pintuck foot with 3 grooves	26	95/95C	Binder foot	21
31	Pintuck foot with 5 grooves	26	97/97D	Patchwork foot	30
32	Pintuck foot with 7 grooves	26		Pintuck attachment	26
33	Pintuck foot with 9 grooves	26		Presser-foot set	33
34/34C/34D	Reverse-pattern foot with clear sole	12		Presser-foot set D	33
35	Invisible-zipper foot	17	Snap-on soles		
37/37D	Patchwork foot	30	SO 1	Reverse-pattern sole	11
38	Piping foot	27	SO 2	Overlock sole	15
39/39C	Embroidery foot with clear sole	27	SO 3	Buttonhole sole	14
40/40C	Sideways-motion foot	28	SO 4	Zipper sole	16
42	BERNINA Stitch Regulator (BSR)	32	SO 5	Blindstitch sole	18
43	Free-motion couching foot	28	SO 8	Jeans-foot sole	18
44C	Echo-quilting and CutWork foot	32	SO 20	Open embroidery foot sole	22
46C	Pintuck and decorative-stitch foot with clear sole	26	SO 37	Patchwork-foot sole	30
47	Spanish hemstitch attachment	27			
50	Three-sole walking foot with seam guide	12			
51	Roller foot	12			
52/52C/52D	Zigzag foot with non-stick sole	11			

Information on the BERNINA Accessories Catalog

Main categories

In the machine overview on the left-hand side, the BERNINA sewing and embroidery machines are listed and divided into the main categories A, B, C, D, E and F. These categories indicate which of the accessories are compatible with which machine models. For space reasons, the special models and the models in category A are not listed in full. Your BERNINA dealer will be happy to help you choose your accessories.

Numerical listing of presser feet

In addition to the machine overview, all BERNINA presser feet and snap-on soles are categorized numerically. This enables you to find the required presser foot quickly based on the corresponding foot number.

Example

1. Find your model in the machine overview and note the category.
2. Find the required accessory in the presser-foot list or in the Table of Contents, and check compatibility based on category.

7 Series

Ea¹ B 700 E

Ea² B 720

Ea³ B 740

Ea⁴ B 770 QE
B 790
B 790PLUS



My BERNINA B 790 is in the category Ea⁴.



50	008 968 73 00	A						
50	008 969 73 00	B	C	D	Ea ²⁻⁴	Eb ²⁻⁴	F	
	032 913 71 00*	A	B	C	D	Ea ²⁻⁴	Eb ²⁻⁴ F	

Walking foot #50 is compatible with the B 790.

Applications of BERNINA presser feet

Each BERNINA presser foot has its own advantages and strengths. In the Table of Contents, the presser feet are listed according to their main application. The icons in the product descriptions indicate additional applications. The first icon always indicates the main application. A detailed overview of the various applications can be found before the Table of Contents.



Three-sole walking foot with seam guide #50







50	008 968 73 00	A						
50	008 969 73 00	B	C	D	Ea ²⁻⁴	Eb ²⁻⁴	F	
	032 913 71 00*	A	B	C	D	Ea ²⁻⁴	Eb ²⁻⁴ F	

* Separate sole for edge-stitching and in-the-ditch stitching.

The walking foot helps to achieve even fabric feeding. It is especially suitable for machine-quilting straight lines and for accurately joining materials that tend to stick and move around, or which have a lot of stretch. Its two seam guides also help you sew with precision.

Scan the QR code to see a video tutorial.

Scan the QR code to see a video tutorial.



Information on BERNINA presser feet

BERNINA presser feet stand for precision and sturdiness. They are easy to change and BERNINA has a suitable presser foot for every application. The sewing feet are divided into two types with different shank openings:



For all models in category A of the Accessories Catalog, presser feet with a 2-point shank opening are used.



For all remaining models in categories B to F of the Accessories Catalog, presser feet with a closed shank opening are used.

Presser feet with a closed shank opening are divided into various types:

For example, Reverse-pattern foot #1/1C/1D for attractive decorative sewing

1



- These presser feet are identified by foot numbers
- For BERNINA sewing and embroidery machines with a maximum stitch width of 5.5mm

1C



- The letter "C" stands for "coded" presser foot, and refers to the sensor that specifies the stitch width to the sewing machine
- For BERNINA sewing and embroidery machines with a maximum stitch width of 9mm
- The soles are longer and wider than on the 5.5mm presser foot

1D



- The letter "D" stands for "Dual Feed". "D" presser feet are used with the BERNINA Dual Feed system. The sole therefore has a recess at the back for the Dual Feed
- For BERNINA sewing and embroidery machines with a maximum stitch width of 9mm
- The sole is reinforced with 2 shanks

Additional distinguishing features of buttonhole feet

3A



- The letter "A" stands for automatic sewing of the buttonhole
- For BERNINA sewing and embroidery machines with a maximum stitch width of 5.5mm
- Variable buttonhole length up to a maximum of 30mm
- The machine measures the length of the buttonhole (mm) via the sensor and completes it automatically

3B



- The letter "B" stands for semi-automatic sewing of the buttonhole
- For BERNINA sewing and embroidery machines with a maximum stitch width of 5.5mm
- Variable buttonhole length up to a maximum of 30mm
- The machine measures the length of the buttonhole (number of stitches) and completes it in stages

Comprehensive information including videos and useful application tips can be found on our website at www.bernina.com.

Overview of the applications of BERNINA presser feet



General sewing

Looking for a presser foot that you can use for different stitches? These universal presser feet are recommended as basic equipment. Some are already included in the standard range of your machine.



Buttons and buttonholes

BERNINA also has a solution for buttonholes. The special buttonhole presser feet let you create precise buttonholes in no time flat. In addition, BERNINA offers a foot for sewing on buttons quickly and easily.



Elastic/stretch materials

Don't have an overlocker to hand? BERNINA offers special presser feet for working with stretch fabrics such as stretch jersey, fabrics containing Lycra, and wool.



Zips

The Zipper foot enables the precise insertion of all sorts of zips. Whether you want to insert normal or invisible zippers – BERNINA has the right foot for you.



Hems and topstitching

Whether for binding an edge or hemming, BERNINA offers a wide range of presser feet that allow you to create the perfect hem finish. Visible and invisible hems can be produced with ease and precision, giving your work a professional look. It is also possible to create hems with lines of topstitching.



Decorative sewing

Brimming with creative ideas that you'd love to give shape to, easily and precisely? The BERNINA range has the right presser foot for a wealth of creative techniques, e.g. the Appliqué foot, which makes appliquéing a breeze.



Embroidery

BERNINA's presser-foot range includes special feet that can be used for both free-motion embroidery and for embroidering in a hoop. BERNINA also naturally offers a wide range of both large and small hoops for all sorts of embroidery projects.



Patchwork

A creative craft that focuses on the details, patchworking is popular among people of all ages. BERNINA has developed special patchwork feet to allow you to join patchwork pieces easily with a special seam allowance.



Quilting

BERNINA quilting feet are ideal for helping you produce elaborate quilting. Our BERNINA Stitch Regulator is particularly innovative, and ensures that your stitches are always the same length, making free-motion quilting a pure pleasure.



Materials that tend to stick

Not all fabrics are equally slippery. For slightly sticky materials such as leather or vinyl, BERNINA has developed special presser feet to facilitate fabric feed.



Presser-foot sets

Our BERNINA presser-foot sets are the ideal basic equipment. Among other things, the sets contain a Zipper foot, an Embroidery foot and a Buttonhole foot.

Chapter 1

Presser Feet

General sewing		Decorative sewing	
Zigzag foot #0 with finger guard #99	11	Embroidery foot #6	22
Zigzag foot with non-stick sole #52/52C/52D	11	Open embroidery foot #20/20C/20D	22
Reverse-pattern foot #1/1C/1D	11	Open embroidery foot with non-stick sole #56	22
Reverse-pattern foot with clear sole #34/34C/34D	12	Gathering foot #16	23
Three-sole walking foot with seam guide #50	12	Ruffler #86	23
Roller foot #51	12	Tailor-tack foot #7	23
Straight-stitch foot with non-stick sole #53	13	Cordonnet foot #11	24
		Braiding foot #21	24
		Cording foot	24
Buttons and buttonholes		Appliqué foot #23	25
Buttonhole foot #3/3C	14	Pintuck foot	26
Buttonhole foot with slide #3A/3B/3C	14	Pintuck and decorative-stitch foot with clear sole #46C	26
Button-sew-on foot #18	14	Pintuck attachment	26
		Spanish hemstitch attachment #47	27
Elastic/stretch materials		Piping foot #38	27
Overlock foot #2/2A	15	Embroidery foot with clear sole #39/39C	27
Bulky overlock foot #12/12C	15	Sideways-motion foot #40/40C	28
		Free-motion couching foot #43	28
Zips		Leather roller foot #55	28
Zipper foot #4/4D	16	Double-cord foot	29
Zipper foot with guide #14/14D	16	Embroidery foot #15	29
Zipper foot with non-stick sole #54	16	Drop-shaped embroidery foot #26	29
Invisible-zipper foot #35	17		
		Patchwork	
Hems and topstitching		Patchwork foot #37/37D	30
Blindstitch foot #5	18	Patchwork foot with guide #57/57D	30
Jeans foot #8/8D	18	Patchwork foot #97/97D	30
Edgestitch foot #10/10C/10D	18		
Straight-stitch hemmer	19	Quilting	
Zigzag hemmer	19	Darning foot #9	31
Roll- and shell hemmer	19	Free-motion embroidery foot #24	31
Lap-seam foot	20	Quilting foot #29/29C	31
Binder attachment for pre-folded bias tape #87	21	BERNINA Stitch Regulator (BSR)	32
Binder attachment for unfolded bias tape #88	21	Echo-quilting and CutWork foot #44C	32
Binder foot #95/95C	21	Adjustable ruler foot #72	32
		Presser-foot sets	
		Presser-foot set	33
		Presser-foot set D	33

Adapter shanks	37	Sewing light	46
Snap-on shank #78	37	Hosiery darning hoop	46
Patchwork seam guide	37	Guide eyelet for metallic and silk thread	46
Straight- and CutWork stitch plate	38	Thread-lubrication unit	47
9mm stitch plate with 5.5mm stitch hole	38	Oil pen	47
5.5mm PunchWork stitch plate	39	BERNINA Ruler Kit	47
PunchWork stitch plate	39	Magnifying-lens set	48
CB-hook bobbins and bobbin cases	40	Mounting bracket for magnifying lens and PunchWork tool	48
Rotary-hook bobbins and bobbin cases	40	PunchWork tool for CB hook machines	48
B9-/BERNINA-hook bobbins and bobbin cases	40	5.5mm PunchWork stitch plate	48
Circular embroidery attachment #83	41	PunchWork tool for rotary-, B9- and	
Eyelet embroidery attachment #82 with foot #92	41	BERNINA-hook machines	49
Presser foot for eyelet embroidery #92	41	PunchWork stitch plate	49
Adjustable guide	42	Felting needles	49
Right and left seam guide	42	BERNINA USB stick	49
Seam guide with scale	42	Multiple-spool holder	50
Fabric-feeding aid for sewing buttonholes	43	Multiple-spool-holder extension	50
Buttonhole leveler	43	BERNINA Accessories box	50
Buttonhole cutter with wooden block	43	Touchscreen pen	51
Extension table	44	Carrying bags for sewing machines	
Seam guide for extension table	44	and embroidery modules	51
Plexiglass extension table for quilting	44	Carrying case	51
Plexiglass extension table for embroidery module	45	BERNINA Accessory bag	52
Knee lifter/Free-Hand System (FHS)	45	Needle assortment	53
Free-Hand System (FHS) retrofit kit	45		

Chapter 2

Accessories for Sewing Machines



Chapter 3

Accessories for Embroidery Machines

BERNINA embroidery modules	57	Maxi embroidery hoop	59
Small embroidery hoop	57	Jumbo embroidery hoop	59
Medium embroidery hoop	57	"Hoop ,n' Buddyz" hoop insert	60
Large embroidery hoop	58	Free-arm-embroidery adapter for small hoop	60
Large oval embroidery hoop	58	Free-arm-embroidery adapter for medium and oval hoops	60
Mega embroidery hoop	58	BERNINA Embroidery Design Studio	61
Midi embroidery hoop	59		

Chapter 4

Software

BERNINA Embroidery Software 8	65	BERNINA DesignWorks tools	67
BERNINA Toolbox	66	BERNINA CrystalWork materials	67
BERNINA DesignWorks Software Suite	67	Straight- and CutWork stitch plate	67
BERNINA DesignWorks Software codes	67	BERNINA DesignWorks spare parts	67

Chapter 5

Accessories for Overlockers/Sergers

General sewing		Other accessories	
Standard presser foot	71	Right and left seam guide	76
Chainstitch foot	71	Extension table	76
		Cut-offs bin	76
Hems and topstitching		BERNINA tweezers	77
Coverstitch/Compensating foot	72	Needle threader/insertor	77
Elasticator foot	72	Brush/Needle inserter	77
Blindstitch foot	72	Screwdriver	78
Hem guide	73	Spool stabilizer	78
		Accessory mounting bracket	78
Decorative sewing		Accessories box	79
Multi-purpose foot with guide	74	Carrying case for overlockers/sergers	79
Cording foot	74		
Gathering foot	74		
Gathering attachment	75		
Decorative-thread guide	75		
Decorative-thread spool pin	75		



Presser Feet



General sewing

Zigzag foot #0 with finger guard #99



0	002 598 72 00	A					Feet without finger guard
0	008 444 73 00	B	C	D	Ea ²⁻⁴	Eb ²⁻⁴	F Feet without finger guard
0	032 722 70 00*	A					Feet with finger guard
99	032 711 70 00	A	B	C	D	Ea ²⁻⁴	Eb ²⁻⁴ F Separate finger guard

* While stocks last

This presser foot is suitable for all utility and decorative stitches with a maximum stitch width of 5.5mm. It can also be used for scallops, gathering work, shell hems, etc. The finger guard is a simple safety device which protects the fingers from injury. It can be mounted on the shaft of most feet.



Zigzag foot with non-stick sole #52/52C/52D



52	002 586 72 00	A						
52	003 076 71 00*	A2						9mm non-stick sole
52	008 477 74 00	B	C	D	Ea ²⁻⁴	Eb ²⁻⁴	F	
52C	008 881 75 00		C	D	Ea ³⁺⁴	Eb ³⁺⁴	F	9mm non-stick sole
52D	032 965 72 00			D	Ea ³⁺⁴	Eb ⁴	F	9mm non-stick sole

* While stocks last

The sole of this foot has a non-stick coating to ensure that it slides smoothly over materials that are difficult to work with, such as plastics, vinyl, leather, and other similar materials.

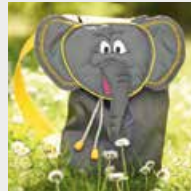

Reverse-pattern foot #1/1C/1D



1	002 576 72 00	A						
1	002 781 70 00*	A2						
1	032 707 71 00	A	B1					Snap-on
1	008 445 74 00	B	C	D	Ea ²⁻⁴	Eb ²⁻⁴	F	
1C	033 202 72 00		C	D	Ea ³⁺⁴	Eb ³⁺⁴	F	
1D	033 220 72 00			D	Ea ³⁺⁴	Eb ⁴	F	

* While stocks last

The Reverse-pattern foot is suitable for various utility and decorative stitches and can also be used for sewing and hemming heavy fabrics such as cord, denim and wool. The indentation in front of and behind the needle hole allows forward and reverse stitching and guarantees excellent fabric feed.



Reverse-pattern foot with clear sole #34/34C/34D



34	030 972 71 00	A					
34C	030 974 70 00*	A2					
34	030 770 72 00	B	C	D	Ea ²⁻⁴	Eb ²⁻⁴	F
34C	030 769 73 00	C	D	Ea ³⁺⁴	Eb ³⁺⁴	F	
34D	032 961 72 00	D	Ea ³⁺⁴	Eb ⁴	F		

* While stocks last

The clear sole of this Reverse-pattern foot ensures a good view of the stitching and needle area. The red markings on the top of the foot allow especially accurate and careful sewing.



Three-sole walking foot with seam guide #50



50	008 968 73 00	A					
50	008 969 73 00	B	C	D	Ea ²⁻⁴	Eb ²⁻⁴	F
	032 913 71 00*	A	B	C	D	Ea ²⁻⁴	Eb ²⁻⁴

* Separate sole for edge-stitching and in-the-ditch stitching.

The walking foot helps to achieve even fabric feed. It is especially suitable for machine-quilting straight lines and for accurately joining materials that tend to stick and move around, or which have a lot of stretch. Its two seam guides also help you sew with precision.



Scan the QR code to see a video tutorial.

Roller foot #51



51	002 953 72 00	A					
51	008 476 73 00	B	C	D	Ea ²⁻⁴	Eb ²⁻⁴	F

The three rollers on the bottom of this foot allow it to glide effortlessly over materials that tend to stick, such as leather, vinyl and plastic.







Straight-stitch foot with non-stick sole #53



53	002 962 73 00	A					
53	008 478 74 00		B	C	D	Ea ²⁻⁴	Eb ²⁻⁴ F

In combination with the straight-stitch plate, this presser foot is ideal for all types of straight-stitching and for narrow seams. Thanks to the non-stick coating on the sole, it passes easily over fabrics that tend to stick during sewing, such as leather and plastics. The two different toe widths serve as guide lines for seam allowances of 3- and 6mm.





Buttons and buttonholes

Buttonhole foot #3/3C



3	002 578 72 00	A							
3	002 767 70 00*	A2							
3	032 714 71 00	A	B1						Snap-on
3	008 447 74 00	B	C	D	Ea ²⁻⁴	Eb ²⁻⁴	F		
3C	033 204 72 00		C	D	Ea ³⁺⁴	Eb ³⁺⁴	F		

* While stocks last

This presser foot lets you sew corded or plain buttonholes in any desired length. It can also be used for gathering using thread or elastic thread (smocking). Ideal for creating the perfect buttonhole together with the buttonhole cutter and button-sew-on foot.



Buttonhole foot with slide #3A/3B/3C



3C	031 250 70 04*	A										
3A	031 250 71 01	B1*	B2	B3	B4	B5	C	D	Ea ²⁻⁴	Eb ²⁻⁴	F	with sensor
3B	031 332 71 00		B1 (125, 125s, 210, 215, 220)									with sensor

* While stocks last

B1* 135, 135s, 145, 145s, 230, 230 PE, 240, 330, 350 PE, 380

For sewing automatic buttonholes with or without cording. The sensor can measure the buttonholes automatically based on the size of the desired button. This allows you to produce any number of buttonholes of the exact same length. Use together with the fabric-feeding aid or the buttonhole leveler as well as the buttonhole cutter and button-sew-on foot to create perfect buttonholes with consummate ease.



Scan the QR code to see a video tutorial.

Button-sew-on foot #18



18	002 959 72 00	A							
18	008 461 74 00	B	C	D	Ea ²⁻⁴	Eb ²⁻⁴	F		
	032 224 50 00	Sole pad							

This presser foot helps you sew on buttons and hooks. The rubberised sole holds the button firmly in the right place while it is being sewn on. The height of the neck can be flexibly adjusted via the middle toe, depending on the fabric thickness.



Scan the QR code to see a video tutorial.

Elastic/stretch materials

Overlock foot #2/2A



2	002 577 72 00	A					
2A	001 694 70 01*	A2					
2	032 716 71 00	A	B1				
2	008 446 74 00	B	C	D	Ea ²⁻⁴	Eb ²⁻⁴	F
2A	033 330 72 01		C	D	Ea ³⁺⁴	Eb ³⁺⁴	F
	315 579 03 2+	Thread guiding sheet					

Snap-on

* While stocks last

The Overlock foot is ideal for sewing overlock seams and neatening edges on elastic materials. The edges of the fabric do not curl, resulting in a flat, elastic seam.



Scan the QR code to see a video tutorial.

Bulky overlock foot #12/12C



12	002 951 71 00	A					
12	002 968 70 00*	A2					
12	008 457 74 00	B	C	D	Ea ²⁻⁴	Eb ²⁻⁴	F
12C	008 878 75 00		C	D	Ea ³⁺⁴	Eb ³⁺⁴	F

* While stocks last

For seaming knits and couching thick cords, strings of beads and sequins, and for making and sewing in piping in a single operation. Boasting a maximum stitch width of 9mm, the #12C foot has a guide hole for sewing over narrow couching cords such as wool, yarn and leather strips.



Scan the QR code to see a video tutorial.

Zips

Zipper foot #4/4D



4	002 579 73 00	A						
4	032 712 71 00	A	B1					Snap-on
4	008 448 74 00	B	C	D	Ea ²⁻⁴	Eb ²⁻⁴	F	
4D	033 221 72 00			D	Ea ³⁺⁴	Eb ⁴	F	

The Zipper foot lets you sew in zips cleanly and accurately in no time flat. The narrow sole is positioned close to the zip teeth in order to sew the zip tape right next to the edge.



Zipper foot with guide #14/14D



14	006 388 72 00	A						
14D	032 964 72 00			D	Ea ³⁺⁴	Eb ⁴	F	

The guide makes it much easier to insert zips straight and to topstitch edges.



Zipper foot with non-stick sole #54



54	002 964 73 00	A						
54	008 479 75 00	B	C	D	Ea ²⁻⁴	Eb ²⁻⁴	F	

The special non-stick coating on the sole makes it easy to sew zips into fabrics that tend to stick, such as leather and plastic.



Scan the QR code to see a video tutorial.

Invisible-zipper foot #35



35	030 820 71 00	A					
35	030 653 72 00		B	C	D	Ea ²⁻⁴	Eb ²⁻⁴ F

Invisible zips look particularly elegant, especially in garments, home decorations and accessories. This foot allows the insertion of a zip such that it is virtually invisible.

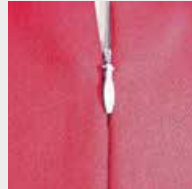

Scan the QR code to see a video tutorial.



Hems and topstitching

Blindstitch foot #5



5	002 580 73 00	A							
5	032 717 71 00	A	B1						
5	008 449 73 00	B	C	D	Ea ²⁻⁴	Eb ²⁻⁴	F		

Snap-on

The blindstitch seam is ideal for garments that are meant to radiate elegance and quality. The needle pierces the fabric so little that the stitch is barely visible on the front. Blindstitching can also be used as a decorative stitch on the front by changing the stitch length/width.

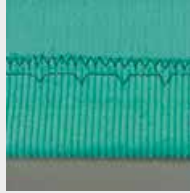

Scan the QR code to see a video tutorial.

Jeans foot #8/8D



8	002 583 72 00	A							
8	036 629 70 00	A	B1						
8	008 453 73 00	B	C	D	Ea ²⁻⁴	Eb ²⁻⁴	F		
8D	032 962 71 00			D	Ea ³⁺⁴	Eb ⁴	F		

Snap-on

Used together with the straight-stitch needle plate, the Jeans foot is ideal for straight-stitching over thick seams and on multilayer or densely woven materials such as denim, canvas or travel bags.



Scan the QR code to see a video tutorial.

Edgestitch foot #10/10C/10D



10	002 585 72 00	A							
10	008 455 74 00	B	C	D	Ea ²⁻⁴	Eb ²⁻⁴	F		
10C	008 877 75 00		C	D	Ea ³⁺⁴	Eb ³⁺⁴	F		
10D	032 960 72 00			D	Ea ³⁺⁴	Eb ⁴	F		

This presser foot with guide is excellent for topstitching edges, hems and pleats. It is also ideal for sewing on lace or ribbon and for reinforcing edges. The guide lets you sew perfect seams and hems running parallel to the edge.



Scan the QR code to see a video tutorial.

Straight-stitch hemmer



62	008 482 73 00	B	C	D	Ea ²⁻⁴	Eb ²⁻⁴	F	2mm
64	002 955 73 00	A						4mm
64	008 484 73 00	B	C	D	Ea ²⁻⁴	Eb ²⁻⁴	F	4mm

Used in combination with the straight-stitch plate, the Straightstitch hemmer creates a hem with particularly beautiful stitching. The fabric is folded over twice in a single operation as it is sewn with a straight-stitch. Feet #62 and #64 are used for hems with a width of 2- and 4mm respectively.



Zigzag hemmer



61	002 956 72 00	A						2mm
61	008 481 73 00	B	C	D	Ea ²⁻⁴	Eb ²⁻⁴	F	2mm
63	002 961 73 00	A						3mm
63	008 483 73 00	B	C	D	Ea ²⁻⁴	Eb ²⁻⁴	F	3mm
66	002 972 71 00	A						6mm
66	008 485 73 00	B	C	D	Ea ²⁻⁴	Eb ²⁻⁴	F	6mm

The Zigzag hemmer sews beautifully decorated non-fraying hems in a single operation. The fabric is folded over twice and sewn down with a zigzag or decorative stitch. Feet #61 and #63 are suitable for fine fabrics. Foot #66 is ideal for medium-weight fabrics.



Roll- and shell hemmer



68	002 958 71 00	A						2mm
68	008 486 73 00	B	C	D	Ea ²⁻⁴	Eb ²⁻⁴	F	2mm
69	001 129 71 00	A						4mm
69	008 487 73 00	B	C	D	Ea ²⁻⁴	Eb ²⁻⁴	F	4mm

This presser foot is deal for hemming soft fabrics such as knitwear. The fabric is folded over twice in a single operation as it is sewn with an overlock stitch. This creates a narrow, slightly three-dimensional hem which does not fray. Feet #68 and #69 are used for hems 2- and 4mm wide respectively.



Scan the QR code to see a video tutorial.

Lap-seam foot



70	008 488 73 00	B	C	D	Ea ²⁻⁴	Eb ²⁻⁴	F	4mm
71	002 973 72 00	A						8mm
71	008 489 73 00	B	C	D	Ea ²⁻⁴	Eb ²⁻⁴	F	8mm

This foot enables precise lap seams to be produced. Since both seam allowances are enclosed and stitched securely in the hem seam, the foot is also suitable for sewing reversible clothing. Foot #70 is suitable for lap seams up to 4mm wide, whilst foot #71 is suitable for lap seams up to 8mm in width.



Scan the QR code to see a video tutorial.

Binder attachment for pre-folded bias tape #87



87	033 505 70 02	A	B	C	D	Ea ²⁻⁴	Eb ²⁻⁴	F	13mm
87	033 505 72 00	A	B	C	D	Ea ²⁻⁴	Eb ²⁻⁴	F	20mm
87	033 505 72 01	A	B	C	D	Ea ²⁻⁴	Eb ²⁻⁴	F	25mm

Binder attachment for unfolded bias tape #88



88	033 505 72 03	A	B	C	D	Ea ²⁻⁴	Eb ²⁻⁴	F	28mm
88	033 505 72 04	A	B	C	D	Ea ²⁻⁴	Eb ²⁻⁴	F	32mm
88	033 505 72 05	A	B	C	D	Ea ²⁻⁴	Eb ²⁻⁴	F	38mm

Binder foot #95/95C



95	033 554 71 10	A							
95C	033 555 70 10*	A2							
95	033 554 71 00	B	C	D	Ea ²⁻⁴	Eb ²⁻⁴	F		
95C	033 555 71 00	C	D	Ea ³⁺⁴	Eb ³⁺⁴	F			

* While stocks last

This binder attachment is used for binding edges with pre-folded bias tape in widths of 13, 20 or 25mm. It enables perfect corners and beautiful curves to be created using utility or decorative stitches. The binder attachment is used in conjunction with Binder foot #95/95C.



This binder attachment creates perfect edge finishes using unfolded bias tape in widths of 28, 32 or 38mm. For the perfect look, the bias tape can also be home-made. The binder attachment is used in combination with Binder foot #95/95C.



This presser foot was specially designed for use with Binder attachments #87 and #88. The notch at the side allows closer access to the binder attachment, making the process easier.



Scan the QR code to see a video tutorial.

Decorative sewing

Embroidery foot #6



6	002 581 71 00	A
6	008 451 73 00	B C D Ea ²⁻⁴ Eb ²⁻⁴ F

Open embroidery foot #20/20C/20D



20	002 588 72 00	A	
20	002 806 71 00*	A2	
20	033 227 70 00	A B1	Snap-on
20	008 462 74 00	B C D Ea ²⁻⁴ Eb ²⁻⁴ F	
20C	003 203 72 00	C D Ea ³⁺⁴ Eb ³⁺⁴ F	
20D	003 151 72 00	D Ea ³⁺⁴ Eb ⁴ F	

* While stocks last

Open embroidery foot with non-stick sole #56



56	008 480 74 00	B C D Ea ²⁻⁴ Eb ²⁻⁴ F
----	---------------	---

The ideal presser foot for buttonhole seams, appliqué and decorative stitches. Superb effects can be achieved by sewing over decorative yarns. The small hole in the centre-front of the foot acts as a guide for a couching cord or elastic thread, but can also be used as a visual guide.



This foot is used to create appliqué and embroidery designs and for sewing over lines and patterns. The open shape ensures a perfect view of the sewing area, making this foot ideal for sewing on ribbons and creating attractive appliqué patterns.



The special non-stick coating on the sole makes it possible to appliqué and do all sorts of embroidery on fabrics that tend to stick during sewing, such as leather, plastic and other similar materials.



Scan the QR code to see a video tutorial.

Gathering foot #16



16	002 596 71 00	A					narrow
16	008 460 73 00	B	C	D	Ea ²⁻⁴	Eb ²⁻⁴	F narrow
16	008 879 73 00		C	D	Ea ³⁺⁴	Eb ³⁺⁴	F wide

Suitable for gathering individual fabric layers or for gathering and simultaneously sewing onto a flat piece of fabric. The thin or medium-weight fabric is fed in unevenly whilst being sewn, giving it its characteristic gathering.



Scan the QR code to see a video tutorial.

Ruffler #86



86	001 944 72 00	A					
86	008 386 75 00	B	C				
86	033 550 72 00		D	Ea ²⁻⁴	Eb ²⁻⁴		F

For creating ruffles or uniform pleats with ease. The pleat density and depth are set directly on the foot. Makes the gathering and uniform pleating of fabrics child's play.



Scan the QR code to see a video tutorial.

Tailor-tack foot #7



7	002 582 72 00	A					
7	008 452 74 00	B	C	D	Ea ²⁻⁴	Eb ²⁻⁴	F

Especially suitable for marking seam lines and also for sewing elegant embellishments, imitation hemstitch (fagoting), fringes and 3D effects.

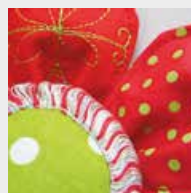

Scan the QR code to see a video tutorial.



Cordonnet foot #11



11	002 952 71 00	A					
11	008 456 73 00		B	C	D	Ea ²⁻⁴	Eb ²⁻⁴ F

This presser foot is ideally suited for sewing and topstitching with cordonnet as the upper thread and for sewing sashiko patterns and the like. The 2mm-deep groove under the sole ensures uniform fabric feed.



Scan the QR code to see a video tutorial.

Braiding foot #21



21	002 595 72 00	A					
21	008 463 73 00		B	C	D	Ea ²⁻⁴	Eb ²⁻⁴ F

This foot lets you guide narrow ribbons and cords with precision whilst couching. The bevelled cutout can accommodate cords and narrow ribbons up to 3mm thick, which can be couched using a utility or decorative stitch.



Cording foot



With 3 grooves							
22	008 465 74 00		B	C	D	Ea ²⁻⁴	Eb ²⁻⁴ F
With 5 grooves							
25	008 468 74 00		B	C	D	Ea ²⁻⁴	Eb ²⁻⁴ F

The grooves allow several strands of side-by-side yarns or narrow ribbons to be couched simultaneously, held in place securely by the latch. This means that the yarns do not need guiding. Foot #22 is designed for three and foot #25 for five side-by-side yarns.



Scan the QR code to see a video tutorial.

Appliqué foot #23



23	002 960 73 00	A					
23	008 466 73 00		B	C	D	Ea ²⁻⁴	Eb ²⁻⁴ F

This presser foot is ideal for appliquéing narrow buttonhole seams of up to 2mm. The specially shaped clear sole provides a perfect view of the sewing area and feeds through dense stitching without a problem, both with straight lines and curves. The notch at the front can also hold a couching thread or ribbon.



Scan the QR code to see a video tutorial.



Pintuck foot



With 3 grooves

30	002 589 71 00	A
30	008 470 73 00	B C D Ea ²⁻⁴ Eb ²⁻⁴ F

With 5 grooves

31	002 590 71 00	A
31	008 471 73 00	B C D Ea ²⁻⁴ Eb ²⁻⁴ F

With 7 grooves

32	002 591 71 00	A
32	008 472 73 00	B C D Ea ²⁻⁴ Eb ²⁻⁴ F

With 9 grooves

33	002 592 71 00	A
33	008 473 73 00	B C D Ea ²⁻⁴ Eb ²⁻⁴ F

Pintuck and decorative-stitch foot with clear sole #46C



46C	033 308 71 00	B C D Ea ²⁻⁴ Eb ²⁻⁴ F
-----	---------------	---

Pintuck attachment



033	270 71 00	B C D Ea ²⁻⁴ Eb ²⁻⁴ F
-----	-----------	---

Pintucks give texture to a fabric surface and are ideal for mini-piping, trimmings, smocking, entredeux and fagoting.



Foot #30: For heavy fabrics such as denim or suit linen, with 4mm twin needle

Foot #31: For medium-weight fabrics, with 3mm twin needle

Foot #32: For fine-to-medium-weight fabrics, with 2mm twin needle

Foot #33: For very fine and lightweight fabrics such as batiste, with 1.6mm twin needle

This foot is specially designed to facilitate the combination of decorative stitches with pintucks. After sewing the pintucks, the same foot can be used to sew beautiful decorative stitches in between the individual pintucks or to couch ribbons. The clear sole provides a good view of the sewing area.



The Pintuck attachment facilitates the sewing of corded pintucks. Simply guide the filler cord through the channel of the attachment. When used in conjunction with the pintuck foot, the cord is automatically incorporated in the pintuck, creating a beautiful raised effect.



Scan the QR code to see a video tutorial.

Spanish hemstitch attachment #47



47 033 809 73 00 B C D Ea²⁻⁴ Eb²⁻⁴ F

The Spanish hemstitch attachment enables you to join fabric edges together with or without a cord and create edge finishes with cording. Use the #20 foot to guide 5.5mm cords and the #20C foot to guide 9mm cords.



Scan the QR code to see a video tutorial.

Piping foot #38



38 030 915 71 00 A

38 031 021 72 00 B C D Ea²⁻⁴ Eb²⁻⁴ F

One side of the piping foot is higher than the other, allowing it to feed fabric layers of different thicknesses evenly. This foot is also suitable for applying thick ribbons, hook-and-loop tape, and thin cords, as well as for piping of narrow-to-medium width.



Scan the QR code to see a video tutorial.

Embroidery foot with clear sole #39/39C



39 031 482 71 00 A

39C 032 860 70 00* A2

39 031 406 72 00 B C D Ea²⁻⁴ Eb²⁻⁴ F

39C 032 171 73 00 C D Ea³⁺⁴ Eb³⁺⁴ F

* While stocks last

This foot is especially suitable for decorative stitches, button-hole seams, appliqués, couching perle yarn, and sewing off-the-edge scallops. It can also be used to create raised effects. The small hole in the centre of the foot acts as a guide for couching a narrow cord. The clear sole provides a good view of the embroidery area.



Scan the QR code to see a video tutorial.

Sideways-motion foot #40/40C



40 006 058 70 00* A2

40C 033 205 71 00 C1 C2 D2 (B 780) Ea⁴ F2

* While stocks last

The perfect tool for sewing sideways-motion patterns, and for sewing utility and decorative stitches in different directions.



Scan the QR code to see a video tutorial.

Free-motion couching foot #43



43 031 779 73 00 B C D E F

Thread guide

43 031 555 50 00 B1 B2 B3 B4 (430,440,555,570) B5 C1

43 033 080 50 00 B4 (630) C2 C3 D E F

This presser foot facilitates the sewing-on of appliqués, using cords, yarns, ribbons and braids with a diameter of 2mm. All sorts of lines and shapes can be created by feeding the cord directly under the needle.



Scan the QR code to see a video tutorial.

Leather roller foot #55



55 031 304 71 01 A

55 031 304 71 00 B C D Ea²⁻⁴ Eb²⁻⁴ F

With its profiled roller, this presser foot is especially suitable for contour quilting and for sewing tight curves on e.g. leather, vinyl and plastic, as well as for quilting and sewing multiple layers of fabric. It can also be used to create jumbo piping.

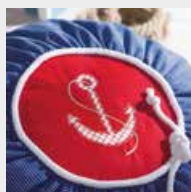

Scan the QR code to see a video tutorial.

Double-cord foot



59C 032 370 72 00	B	C	D	Ea ²⁻⁴	Eb ²⁻⁴	F	4–6mm
60C 032 370 72 01	B	C	D	Ea ²⁻⁴	Eb ²⁻⁴	F	7–8mm

For simultaneously sewing on two parallel cords with a diameter of 4–6mm or 7–8mm. The versatile Double-cord foot is also ideal for sewing on piping.



Scan the QR code to see a video tutorial.

Embroidery foot #15



15 032 708 71 00	B	C	D	E	F
-------------------------	---	---	---	---	---

This foot is ideally suited for appliqué work and free-motion quilting. Its slightly-upwards-curving shape makes it easier to sew on pile and bulky fabrics and to embroider over appliqué designs and densely embroidered motifs.



Scan the QR code to see a video tutorial.

Drop-shaped embroidery foot #26



26 031 597 71 00	B	C	D	E	F
-------------------------	---	---	---	---	---

Used together with a straight-stitch plate, this embroidery foot is particularly suitable for tasks that use the embroidery module, as well as for darning fine fabrics. The drop-shaped needle opening and the shape of the presser-foot sole reduce damage to the upper thread, contributing to an attractive embroidery result.



Patchwork

Patchwork foot #37/37D



37	001 127 72 00	A						
37	036 631 70 00	A	B1					Snap-on
37	008 474 74 00	B	C	D	Ea ²⁻⁴	Eb ²⁻⁴	F	
37D	033 152 72 00		D		Ea ³⁺⁴	Eb ⁴	F	

This foot is ideally suited to patchwork projects with seam allowances of 3mm ($\frac{1}{8}$ ") or 6mm ($\frac{1}{4}$ "). The three notches on the side ensure precise guidance for inserting rectangular patchwork pieces.



Patchwork foot with guide #57/57D



57	032 148 71 00	A						
57	031 577 72 00	B	C	D	Ea ²⁻⁴	Eb ²⁻⁴	F	
57D	032 963 72 00		D		Ea ³⁺⁴	Eb ⁴	F	

Patchwork foot #57/57D differs from Patchwork foot #37/37D in that it has an additional guide enabling perfectly straight lines to be sewn.



Scan the QR code to see a video tutorial.

Patchwork foot #97/97D

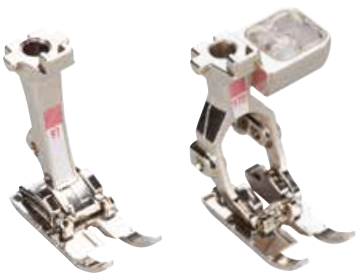

97	035 927 70 00	C	D	Ea ³⁺⁴	Eb ³⁺⁴	F		
97D	035 928 70 00		D	Ea ³⁺⁴	Eb ⁴	F		

This patchwork foot is ideal for creating beautiful quilts and other precision sewing work. The markings on the sole for seam allowances of 3mm ($\frac{1}{8}$ "), 6mm ($\frac{1}{4}$ ") and 7.5mm ($\frac{3}{10}$ ") ensure accurate guiding. The contact area of this foot is perfect for machines with a 9mm stitch width, and enables careful guiding of the fabric and stitching when joining pieces of fabric together.



Scan the QR code to see a video tutorial.

Quilting

Darning foot #9



9	002 584 72 00	A
9	008 454 74 00	B C D Ea ²⁻⁴ Eb ²⁻⁴ F

Free-motion embroidery foot #24



24	002 593 72 00	A
24	008 467 74 00	B C D Ea ²⁻⁴ Eb ²⁻⁴ F

Quilting foot #29/29C



29	001 128 71 00	A
29	008 469 73 00	B C D Ea ²⁻⁴ Eb ²⁻⁴ F
29C	008 880 74 00	C D Ea ³⁺⁴ Eb ³⁺⁴ F

The special shape of this multi-purpose foot makes it particularly suitable for free-motion embroidery, contour quilting, and producing attractive lace and monograms. Small holes and tears can also be repaired using the hosiery darning hoop.



The open embroidery sole offers a free, unobstructed view of the embroidery area. Precise and creative free-motion projects such as monogram, silk-ribbon and Richelieu embroidery and thread painting can be accomplished with ease. The free-motion embroidery foot is also excellent for contour quilting and free-motion quilting of tiny details (microstippling).



This quilting foot is used for topstitching quilts with thick and thin padding. The clear sole ensures an unobstructed view of the entire sewing area, which is important for positioning stitches precisely. The foot is especially suited to free-motion quilting tasks such as contour quilting, thread painting and stipple quilting.



Scan the QR code to see a video tutorial.

BERNINA Stitch Regulator (BSR)



031 472 74 01 B4 B5 C2 (730) C3 D Ea²⁻⁴ Eb²⁻⁴ F

The perfect foot for free-motion quilting with a controlled stitch length on all materials. The BSR reacts to the movement of the fabric and controls the speed of the needle during free-motion sewing. The set stitch length is maintained irrespective of the movement of the fabric, resulting in absolutely even stitch formation.



Scan the QR code to see a video tutorial.

Echo-quilting and CutWork foot #44C



44C 033 369 72 00 B C D E F

This presser foot is the ideal companion for a host of creative sewing projects such as echo and shadow quilting, free-motion quilting, thread painting, and free-motion embroidery with zigzag stitch. The disc-shaped clear sole moves easily over raised areas of fabric. The crosshair and concentric circular markings help you position the stitches precisely. In addition, this foot produces excellent cutting results with CutWork designs.



Scan the QR code to see a video tutorial.

Adjustable ruler foot #72



101 786 70 00 B C D Ea²⁻⁴ Eb²⁻⁴ F

Use this adjustable foot to sew along a 1/4-inch-thick Plexiglass ruler and create decorative quilt designs such as lines, feathers and circles. The markings on the inside and outside allow for precise sewing, and the dial lets you adjust the height of the foot individually to the fabric thickness.



Scan the QR code to see a video tutorial.

Presser-foot sets

Presser-foot set



031 662 71 00 B Ea² Eb²

This set for 5.5mm machines contains the following 5 practical presser feet for special stitches and sewing tasks:

- Reverse-pattern foot #1
- Buttonhole foot #3
- Buttonhole foot with slide #3B
- Zipper foot #4
- Blindstitch foot #5



Presser-foot set D



031 662 71 01 D Ea³⁻⁴ Eb⁴ F

This set for 9mm machines contains the following presser feet and represents a useful basic set:

- Jeans foot #8D
- Edgestitch foot #10D
- Open embroidery foot #20D
- Reverse-pattern foot with clear sole #34D
- Patchwork foot #97D







Accessories for Sewing Machines





Adapter shanks



Standard

75	032 705 71 00	A					
75	032 702 71 00	B	C	D	Ea ²⁻⁴	Eb ²⁻⁴	F

Short

77	032 713 71 00	A					
77	032 710 71 00	B	C	D	Ea ²⁻⁴	Eb ²⁻⁴	F

Adapter shanks are used to attach various accessories to the machine.

Snap-on shank #78



032 703 71 00	A1 (1008)						
032 725 71 00		B	C	D	Ea ²⁻⁴	Eb ²⁻⁴	F

Snap-on presser feet consist of a snap-on shank and various snap-on soles, depending on their use. A clamping mechanism ensures easy and secure attachment of the sole.

Patchwork seam guide



032 706 71 00 ¹	A	B	C	D	Ea ²⁻⁴	Eb ²⁻⁴	F
330 030 13 1+ ²	A	B	C	D	Ea ²⁻⁴	Eb ²⁻⁴	F

¹ Set incl. screw. ² Screw.

The Patchwork seam guide helps you sew patchwork and hems accurately. It can be adjusted to sit right at the edge of the presser foot, or can be attached a slight distance from the edge of the foot.



In addition to the standard stitch plate supplied with the machine, BERNINA offers other stitch plates for specific applications. Each has its own colour code identifying it with the relevant application. The stitch plates differ from one another mainly in terms of the design of the needle hole and the engraved measurements in mm, inches, or a combination of both.

Straight- and CutWork stitch plate



mm	006 857 70 00	A1 (1000–1530)		
mm	003 098 70 00	A2		
Inch	003 098 70 01	A2		
mm/Inch	033 339 70 04	B1 (125–145)		
mm/Inch	033 339 72 00	B1 (210–380) B4 B5		
mm/Inch	033 339 70 03	B2 B3		
mm/Inch	033 339 71 02		C1 C2	1.4mm
mm/Inch	008 865 71 03		C1 C2	2.0mm
mm/Inch	033 339 73 13		C3	
mm/Inch	033 339 71 07		D Ea ³⁺⁴ Eb ³⁺⁴	
mm/Inch	033 339 70 14		Ea ² Eb ²	
mm/Inch	034 914 70 00			F

The Straight and CutWork stitch plate is colour-coded orange. It can be used for straight-stitching and embroidery, as well as for CutWork and CrystalWork projects. When straight-stitching, perfect stitch formation is achieved by using this stitch plate with a presser foot with a small opening, such as foot #8, #26, #53, #62 or #64.



1. Round needle hole for straight-stitch and other creative work
2. Opening for feeding in an additional yarn on the underside of the fabric



9mm stitch plate with 5.5mm stitch hole



mm	006 216 70 01	A2		
mm/Inch	033 339 71 11		C1 C2	
mm	033 339 71 10		C3	
Inch	031 045 70 01		C3	
mm/Inch	033 339 70 08		D Ea ³⁺⁴ Eb ³⁺⁴	
mm	034 915 70 00			F

Colour-coded purple, this stitch plate has a reduced needle-hole width of 5.5mm. Suitable for all 9mm machines, it achieves particularly good results when sewing thin or soft materials. All zigzag and decorative stitches up to a width of 5.5mm can be used to create detailed sewing projects.



1. 5.5mm needle hole for zigzag and decorative stitches
2. Opening for feeding in an additional yarn on the underside of the fabric



5.5mm PunchWork stitch plate



033 371 70 06	B1 (125–145S)	
031 050 70 10	B1 (210–380)	B4 B5
007 874 71 10		B2 B3

This CB-hook stitch plate can be used for both sewing and felting. The large round opening is for the felting needles.

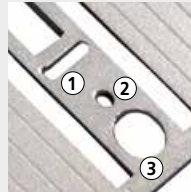

1. 5.5mm needle hole for all types of sewing
2. Opening for feeding in an additional yarn on the underside of the fabric
3. Opening for felting needles



Scan the QR code to see a video tutorial.

PunchWork stitch plate



033 691 70 00	C1 C2	
033 690 70 00	C3	
033 339 71 06	D Ea ^{1,3+4} Eb ^{1,3+4}	
033 685 71 00		F

Colour-coded yellow, this stitch plate has three needle holes arranged lengthways for the felting needles. Close guiding of the needles means better support of the material.

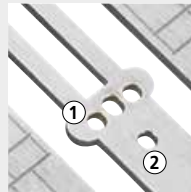

1. Triple needle hole for felting needles
2. Opening for feeding in an additional yarn on the underside of the fabric



Scan the QR code to see a video tutorial.

CB-hook bobbins and bobbin cases

**Individual bobbins**

1	001 536 72 00	A1 (910-933/1004-1031/1080-1530)	B
---	---------------	----------------------------------	---

Bobbin case for sewing and embroidery

2	034 320 71 07	A1 (910-933/1004-1031/1080-1530)	B
---	---------------	----------------------------------	---

Bobbin case for bobbinwork

3	034 320 71 06	A1 (910-933/1004-1031/1080-1530)	B
---	---------------	----------------------------------	---

Rotary-hook bobbins and bobbin cases

**Individual bobbins**

1	330 026 03 0+	A1 (940/950)		
---	---------------	--------------	--	--

2	006 026 53 00	A1 (1000-1001/1050-1070)	A2	C
---	---------------	--------------------------	----	---

3	032 295 53 00			F
---	---------------	--	--	---

Bobbins in canister (5 pcs.)

3	033 210 71 00			F
---	---------------	--	--	---

Bobbin case for sewing

4	034 320 71 05	A1 (1000-1001/1050-1070)	A2	C
---	---------------	--------------------------	----	---

Bobbin case for embroidery

5	034 320 71 04			C
---	---------------	--	--	---

B9-/BERNINA-hook bobbins and bobbin cases

**Individual bobbins**

1	033 436 54 00		D	E
---	---------------	--	---	---

Bobbins in canister (5 pcs.)

1	033 210 70 01		D	E
---	---------------	--	---	---

Bobbin case for sewing and embroidery

2	034 320 71 01		D	
---	---------------	--	---	--

3	034 320 71 03			E
---	---------------	--	--	---

Bobbin case for bobbinwork

4	034 320 70 00		D	
---	---------------	--	---	--

5	034 320 71 02			E
---	---------------	--	--	---

Each BERNINA hook system has its own bobbin cases for sewing, embroidery and bobbinwork. There is a bobbin to match each bobbin case.

The 7 Series has two hooks: the B9 Hook and the BERNINA Hook.

To distinguish between them, all BERNINA Hook components are marked with a triangle (△), as are the bobbin cases.



Scan the QR code to see a video tutorial.

Circular embroidery attachment #83



83 008 373 73 00 B C D Ea²⁻⁴ Eb²⁻⁴ F

The Circular embroidery attachment allows you to sew fancy and decorative circles or semicircles of various diameters using utility or decorative stitches or lettering. It is also suitable for appliquéing ribbons. Using the extension table increases the sewing-bed area, making it ideal for precise decorative sewing.



Scan the QR code to see a video tutorial.

Eyelet embroidery attachment #82 with foot #92



82 008 359 73 00 B C D Ea²⁻⁴ Eb²⁻⁴ F

Used with presser foot #92 (included), this device enables you to embroider beautiful decorative and functional eyelets, which are very popular on sportswear and materials such as jersey.

Presser foot for eyelet embroidery #92



92 032 718 70 00 B C D Ea²⁻⁴ Eb²⁻⁴ F

Suitable for use with Eyelet embroidery attachment #82, this free-motion embroidery foot is used to embroider eyelets and for functional decorative purposes.



Scan the QR code to see a video tutorial.

Adjustable guide



032 855 70 00 A B C D Ea²⁻⁴ Eb²⁻⁴ F

The adjustable guide consists of a guide tool and an edge guide, and allows you maintain even spacing between rows of straight or decorative stitching. It is very helpful when making quilted lining, patchworking, or engaging in other decorative sewing tasks. The adjustable edge guide is used primarily to create precise seams and perfect hems, and ensures particularly good results when edge-stitching. The guide tool and edge guide can be attached to the shaft of most presser feet.



Right and left seam guide

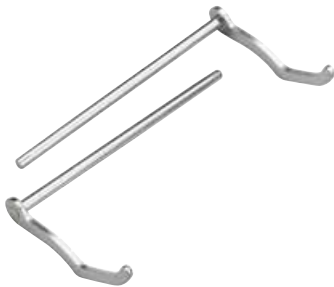

033 338 70 00 A B C D Ea²⁻⁴ Eb²⁻⁴ F right

033 338 70 01 A B C D Ea²⁻⁴ Eb²⁻⁴ F left

This seam guide for the right or left of the needle is a guide tool. It is used to maintain parallel spacing between rows of stitching and for neat, straight edges and hems.

Seam guide with scale



003 027 71 00 A B C D Ea²⁻⁴ Eb²⁻⁴ F Set

Used as a guide tool to the right and left of the needle, the Seam guide with scale helps with traditional sewing tasks as well as with more complex sewing projects. Marked in centimetres and inches, the scale allows you to sew parallel lines accurately and to maintain an even distance between rows of stitching.



Fabric-feeding aid for sewing buttonholes



031 247 70 00 B C D Ea²⁻⁴ Eb²⁻⁴ F

Used in conjunction with the Buttonhole foot with slide #3A/3B, this tool improves fabric feed when sewing buttonholes in thick, fluffy and elastic fabrics.



Scan the QR code to see a video tutorial.

Buttonhole leveler



033 332 70 01 A2 B1 (135-145/230-380) B2 B3 B4 B5 C D Ea²⁻⁴ Eb²⁻⁴ F wide
033 332 70 00 A1 (1130,1230) narrow

The leveler improves the feed of the Buttonhole foot with slide #3A/3C when sewing buttonholes in fabrics of different heights, e.g. along finished edges.

Buttonhole cutter with wooden block



032 580 71 00 A B C D Ea²⁻⁴ Eb²⁻⁴ F

Measuring 1.3mm (1/2") in width, this buttonhole cutter is used to open up sewn buttonholes.



Scan the QR code to see a video tutorial.

Extension table

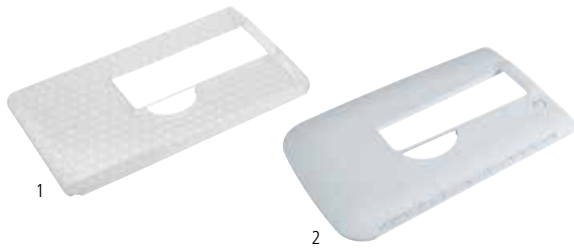

	003 175 70 00	A1 (1008)	
1	030 347 51 01	B1 (125–240)	
1	033 045 70 00	B1 (330–380)	
1	031 073 51 01	B4 C3	
1	033 114 71 00	B4 B5 C3	with quick-release button
2	008 868 50 00	B2 B3 C1 C2	
2	033 131 70 00		D Ea
2	102 324 70 00		Eb
2	031 846 72 00		F

Seam guide for extension table



	002 909 51 00	A1 (1008)	
	033 046 70 00	B1 (330–380) B4 B5 C3	
	030 726 70 00	B2 B3 C1 C2	
	032 527 71 00		D Ea ²⁻⁴ F
	033 046 70 00		Eb ²⁻⁴

The Extension table increases the work surface whilst facilitating fabric passage over the free-arm.



The Seam guide for extension table is a useful tool for topstitching wide borders and hems.



Plexiglass extension table for quilting



	030 129 71 01	A1 (1000–1530) A2	60 x 45 cm
	030 839 50 00	B1	60 x 60 cm
	030 129 71 02	B2 B3 C1 C2	60 x 60 cm
	030 129 72 04	B4 B5 C3	60 x 60 cm
	030 129 72 08		D Ea ²⁻⁴ 60 x 45 cm
	030 129 70 10		Eb ²⁻⁴ 60 x 45 cm
	030 129 71 06		F 60 x 45 cm

The Extension table for quilting increases the work surface of the sewing machine, which is very helpful when working on large quilting and sewing projects.



Plexiglass extension table for embroidery module



030 129 71 05	B4 B5 C3	60 x 45 cm
030 129 71 03	B3 C1 C2	60 x 45 cm

The Extension table for embroidery module provides additional space around the embroidery hoop, thereby distributing the weight of large embroidery projects evenly.



Knee lifter/Free-Hand System (FHS)

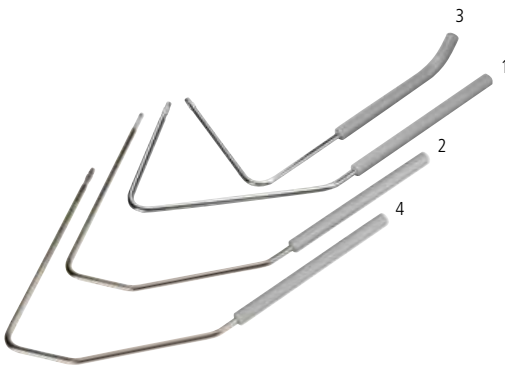

1 001 635 77 00	A B C
2 001 635 77 01	A B C D Ea ²⁻⁴ Eb ²⁻⁴
3 001 635 73 02	A B1 B2 B3 B4 C
4 001 635 77 04	F

BERNINA's unique Free-Hand System (FHS) lets you raise the presser foot while simultaneously lowering the feed dog via a knee-operated lever. This also increases the gap between stitch plate and presser foot, and leaves both hands free to guide your project.

- 1 FHS Standard
- 2 FHS for sewing-machine cabinet
- 3 FHS Special (short)
- 4 FHS Standard

Free-Hand System (FHS) retrofit kit

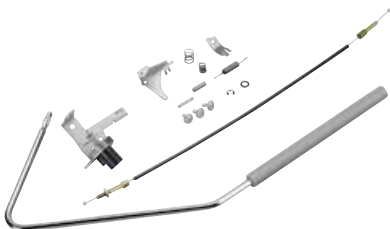

030 146 70 00	B1
008 610 71 00	B2 B3 C1

The retrofit kit is ideal for retrofitting a knee lifter.



Sewing light

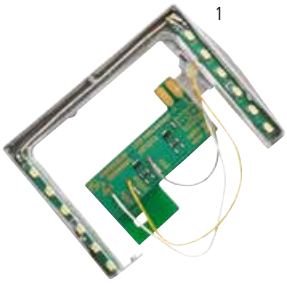

030 753 70 00	B1 (125–240)	CFL
1 004 992 74 00	B2 (155+163) B3 C1 (185) C2	LED
030 683 74 00	B4	C3 CFL

Boasting a very long service life, this light illuminates the sewing area with bright-as-day light, allowing you to sew with precision and accuracy.



Hosiery darning hoop



001 548 71 01	A B1 B4 B5 C3
001 548 71 03	B2 B3 C1 C2 D Ea ²⁻⁴ Eb ²⁻⁴ F

Used together with Darning foot #9, the Hosiery darning hoop lets you darn hosiery, socks and other textiles in no time flat, and prevents the fabric from puckering or wrinkling.



Guide eyelet for metallic and silk thread



008 814 70 00	B C
----------------------	-----

This eyelet acts as an additional thread guide, preventing metallic and silk threads from slipping off the spool, and allowing you to work with two or three threads simultaneously.



Thread-lubrication unit



031 161 71 00	A B C D E
033 596 70 00	F
031 963 50 00	Silicone fluid

The use of the Thread-lubrication unit is particularly recommended when working with metallic and loosely twisted threads. The silicone fluid greatly improves the friction properties of these threads and effectively protects delicate threads from damage and breaking.



Scan the QR code to see a video tutorial.

Oil pen



033 567 70 01	D Ea Eb F
---------------	-----------

Regular care ensures that your sewing machine runs smoothly. This includes oiling it with the handy Oil pen.



BERNINA Ruler Kit



012 379 70 01	B C D Ea ²⁻⁴ Eb ²⁻⁴ F
---------------	---

These rulers can be used in combination with the Adjustable ruler foot #72 to create decorative quilt patterns. The height of the individual rulers allows for easy handling together with the quilt project below the presser foot.



Scan the QR code to see a video tutorial.

Magnifying-lens set



008 264 75 00 A B C D E F

Mounting bracket for magnifying lens and PunchWork tool



1	033 853 70 01	B1
2	033 853 70 00	B2 B3 C1 C2
3	033 853 70 02	B4 B5 C3
4	033 853 72 03	D E
4	032 052 70 00	F

The practical Magnifying-lens set enhances your view of the working area. The three lenses have magnification factors of 1.25, 1.5 and 2, making it easier to thread the needle and sew tricky areas. The set can also be used with a hand holder as a practical reading lens.



Mounting bracket for attaching the magnifying lens or PunchWork tool.



Scan the QR code to see a video tutorial.

PunchWork tool for CB hook machines



031 571 71 00 B

5.5mm PunchWork stitch plate

033 371 70 06	B1 (125–145S)
031 050 70 10	B1 (210–380) B4 B5
007 874 71 10	B2 B3

Ideal for needle-felting with wool yarns or loose wool fibres, the PunchWork tool for CB-hook machines lets you work decorative designs and motifs into fabrics such as felt, wool, loden cloth, fulled fabrics and denim with no Lycra. This tool should be used in conjunction with the 5.5mm PunchWork stitch plate.



Scan the QR code to see a video tutorial.

PunchWork tool for rotary-, B9- and BERNINA-hook machines



033 678 72 00 C D Ea^{1,3+4} Eb^{1,3+4} F

The ideal tool for needle-felting with wool yarns or loose wool fibres, allowing decorative designs and motifs to be worked into fabrics such as felt, wool, loden cloth, fulled fabrics and denim with no Lycra. The clear finger guard is height-adjustable, and there is a holder at the front and back for different thicknesses of felting yarn and tapes. This tool should be used in conjunction with the PunchWork stitch plate.

PunchWork stitch plate

033 691 70 00	C1 C2
033 690 70 00	C3
033 339 71 06	D Ea ^{1,3+4} Eb ^{1,3+4}
033 685 71 00	F



Scan the QR code to see a video tutorial.

Felting needles



1	032 178 70 00	B	long
2	033 940 70 00	C D Ea ^{1,3+4} Eb ^{1,3+4} F	short

Felting needles are special barbed needles which punch fibres into a base fabric for decorative purposes.

BERNINA USB stick



033 623 70 05 C3 (560/580) D E F 4 GB

The USB stick is a handy portable storage medium for storing data, embroidery patterns and update files.

Multiple-spool holder



008 983 74 00 B2 B3 B4 B5 C D E F

Multiple-spool-holder extension



008 979 71 00 B2 B3 B4 B5 C D E F

The Multiple-spool holder enables rapid access to threads as well as quick colour changes, which is especially useful for multi-coloured embroidery motifs. The path from the telescopic thread stand to the needle is also longer, allowing difficult yarns to untangle before being sewn.

This practical extension allows even more spools to be used.



Scan the QR code to see a video tutorial.

BERNINA Accessories box



030 396 71 04	B1 (125–240)
030 396 72 13	B1 (330–380) B5 C3 (560,580)
030 396 71 03	B2 B4 (430,440,630)
030 396 72 14	B4 (555,570)
030 396 71 01	C1 C2
030 396 72 05	C3 (435,450,640)
030 396 71 12	D Ea
102 323 70 00	Eb
030 396 73 11	F

The practical BERNINA accessories box stores your presser feet, bobbins, needles and tools neatly so they are always visible and to hand. The Accessories box can be kept on the work bench or mounted on the wall.



Touchscreen pen



For easy operation of the touchscreen on sewing and embroidery machines. The pen is magnetic and can be attached to the right side of the machine. Using the touchscreen pen helps keep the screen clean.

033 333 71 00	B3 B4 (555,570,630) C1 C2 C3 (560,580,640) D Ea F
102 670 50 00	Eb

Carrying bags for sewing machines and embroidery modules



Keep your sewing machine and embroidery module in tip-top condition while you're travelling. The inner compartments provide additional space for storing accessories.

1 033 284 52 00	B C
2 030 895 50 03	B3 B4 C

Carrying case



The Carrying case protects your sewing machine from dust and dirt. It has a built-in accessories compartment.

001 898 72 02*	A1 (1000–1050)
001 559 71 07*	A1 (1070–1530) A2
031 101 71 00	B2 B3 C1 C2

* While stocks last

BERNINA Accessory bag



037 214 70 00 A B C D E F

The practical accessory bag can either be attached to the trolley, or carried as a shoulder bag or rucksack. The various pockets inside and outside provide plenty of space for presser feet, accessories and a 15-inch laptop.



L trolley system for 2, 3 and 5 Series



1 036 180 70 01 A B C Eb
2 033 476 70 01 B3 B4 C Eb

The practical trolley and embroidery-module bag are very sturdy, and are perfect for transporting your machine when you're on the go. Numerous inner and outer pockets offer plenty of room for accessories. Robust wheels and an extendable telescopic handle allow you to pull your sewing machine and attached embroidery module behind you with ease. The side handles are also convenient when loading and unloading the bags. The embroidery-module bag can be attached to the trolley's telescopic handle or carried separately with the adjustable shoulder strap.

XL trolley system for 7 and 8 Series



1 036 180 70 00 D Ea F
2 033 476 70 00 D2 Ea^{1,2+4} F2



Scan the QR code to see a video tutorial.

Needle assortment



The BERNINA needle assortment contains high-quality needles of various types and sizes for different materials and applications.



Scan the QR code to see a video tutorial.

BERNINA flat-shank needles

	NEEDLE TYPE	COLOUR APPLICATION	COLOUR NEEDLE SIZE NM							
			60	70	80	90	100	110	120	
SHORT-GROOVE NEEDLE	130/705 H Universal needle	No colour	•	•	•	•	•	•	•	•
	130/705 H-J Jeans needle	Blue			•	•	•	•		
	130/705 H-M Microtex needle	Violet	•	•	•	•				
	130/705 H-N Topstitch needle	Light green			•	•	•			
	130/705 H-Q Quilting needle	Green			•	•				
	130/705 H WING Hemstitch needle	No colour					•		•	
	130/705 H METAFIL Metafil needle	Antique pink			•					
	130/705 H-E Embroidery needle	Red			•	•				
	130/705 H SUK Jersey / Embroidery needle	Orange	•	•	•	•	•			
	130/705 H-S Stretch needle	Yellow			•	•				
	130/705 H SES Fine-fabrics needle	No colour		•	•	•				
	130/705 H LR Leather needle	Brown				•	•			
	LONG-GROOVE NEEDLE	130/705 H PRO Universal needle	No colour				•	•	•	•
		130/705 H-J PRO Jeans needle	No colour			•	•	•		
		130/705 H SUK PRO Jersey / Embroidery needle	No colour			•	•	•		
	SPECIAL NEEDLE	130/705 H ZWI Universal twin needle	No colour		•	•	•	•		
Gap (mm)			1.6	2.0	3.0	4.0				
130/705 H-S ZWI Stretch twin needle		No colour		•	•	•				
Gap (mm)			2.5	4.0	6.0					
130/705 H ZWIHO Hemstitch twin needle		No colour				•	•			
Gap (mm)						2.5				
130/705 H DRI Universal triple needle		No colour			•					
Gap (mm)				3.0						
Punch Felting needle	No colour									
130/705 H DE Double-eye needle	No colour			•						
ELX 705 CF Coverstitch needle	Black				•					

* only available in an assortment.



Accessories for Embroidery Machines





BERNINA embroidery modules

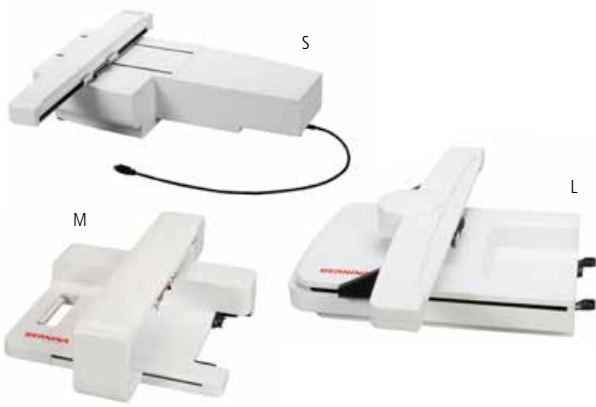

S	024 580 90 XX ¹	B4 C2(200) C3
M	024 590 90 XX ¹	Eb
L	024 830 92 XX ¹	D2 Ea ^{1,2+4} F2

¹ Last two digits vary depending on country.

The large embroidery area of the embroidery module makes working on your creative projects a breeze. The embroidery module turns a BERNINA sewing machine into an embroidery machine, enabling you to produce stunning and reliable results in a next to no time.



Small embroidery hoop



1	030 869 71 00	B4 C1 (185) C2 C3 D2 Ea ^{1,2+4} Eb F2
2	008 916 70 00	B3 C1 (180)

For small embroidery designs and free-arm embroidery of tubular items such as sleeves, trouser legs and socks. The template allows accurate positioning of the motif on the item to be embroidered.

Embroidery area:
1: 5.0 × 7.2cm
2: 4.0 × 6.0cm



Scan the QR code to see a video tutorial.

Medium embroidery hoop



1	030 871 71 00	B4 C1 (185) C2 C3 D2 Ea ^{1,2+4} Eb F2
2	008 915 70 00	B3 C1 (180)

This hoop is large enough to accommodate attractive medium-sized embroidery designs. The template allows accurate positioning of the motif on the item to be embroidered.

Embroidery area:
10 × 13cm



Scan the QR code to see a video tutorial.

Large embroidery hoop



008 914 73 00 B3 C1 (180)

The big embroidery hoop for large-scale embroidery designs or combinations of motifs. The template allows accurate positioning of the motif on the item to be embroidered.

Embroidery area:
15.5 × 20cm



Scan the QR code to see a video tutorial.

Large oval embroidery hoop



030 870 73 00 B4 C1 (185) C2 C3 D2 Ea^{1,2+4} Eb F2

030 575 50 01 Template B4 C1 (185) C3 orange

030 575 51 00 Template C2 D2 Ea^{1,2+4} Eb F2 violet

Designed for large embroidery projects, the large oval hoop is ideal for combining several small motifs. The template allows accurate positioning of the motif on the item to be embroidered.

Embroidery area:
14.5 × 25.5cm



Scan the QR code to see a video tutorial.

Mega embroidery hoop



030 580 75 00 B4 C2 C3 D2 Ea^{1,2+4} Eb F2

The embroidery hoop for extra-large embroidery designs and combinations of motifs, as well as borders. The three embroidery positions allow you to embroider precisely without mismatches or gaps. The template allows accurate positioning of the motif on the item to be embroidered.

Embroidery area:
15 × 40cm



Scan the QR code to see a video tutorial.

Midi embroidery hoop



102 374 70 00 Ea^{1,2+4} Eb F2 (830/880)

Designed for large embroidery projects, the oval Midi hoop is ideal for combining several small motifs. A large knob with a ratchet mechanism allows easy hooping and unhooping of the material. The template serves as a support for accurately positioning the motif on the item to be embroidered.

Embroidery area
16.5 × 26.5cm

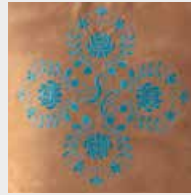

Maxi embroidery hoop



034 925 70 00 D2 Ea^{1,2+4}

This embroidery hoop is for especially large embroidery designs and combinations of motifs, as well as borders. A large rotating knob with a ratchet mechanism allows for easy hooping and unhooping of the material. The template enables accurate positioning of the motif on the item to be embroidered.

Embroidery area:
40 × 21cm



Scan the QR code to see a video tutorial.

Jumbo embroidery hoop

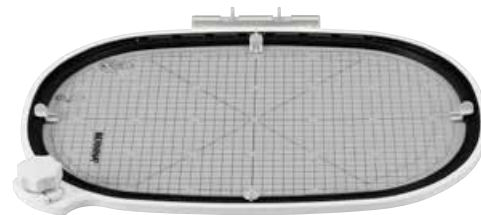

032 842 73 00 D2 Ea^{1,2+4} F2

Ideal for especially large embroidery projects, this hoop excels at creating extra-large embroidery designs, combinations of motifs, and borders. A large rotating knob with a ratchet mechanism allows for easy hooping and unhooping of the material. The template enables accurate positioning of the motif on the item to be embroidered.

Embroidery area:
40 × 26cm



Scan the QR code to see a video tutorial.

"Hoop ,n' Buddyz" hoop insert



031 184 70 00 B4 C1 (185) C2 C3 D2 Ea^{1,2+4} Eb F2

Used in conjunction with the large oval embroidery hoop, this hoop is ideal for embroidering caps and for working with slippery or difficult materials.



Scan the QR code to see a video tutorial.

Free-arm-embroidery adapter for small hoop



008 913 72 00 B3 B4 C

Free-arm-embroidery adapter for medium and oval hoops



033 648 70 00 B4 C1 (185) C2 C3

These adapters provide you with more space, making them ideal for embroidering tubular and closed sewing projects such as trouser legs, blouses, coat pockets and small T-shirts. They are designed for use with the small embroidery hoop/ medium and oval embroidery hoops, respectively.



Scan the QR code to see a video tutorial.

BERNINA Embroidery Design Studio



Finding attractive embroidery motifs

The BERNINA Embroidery Design Studio is an online library that makes tens of thousands of professionally digitised motifs available to embroiderers. Simply enter a term or an embroidery technique in the web shop's search box and select, pay for and download your desired motif from the preview – it couldn't be easier!

Embroidering the motifs

The motifs are downloadable in all common data formats, and can be embroidered on almost any sewing and embroidery machine. The BERNINA ArtLink Software, which is available free of charge, allows you to view the motifs and change their formats if necessary.

www.berninadesignstudio.com

BERNINA ArtLink Software for free download

www.bernina.com/support/ArtLink-V7





Software



BERNINA Embroidery Software 8



Full Version DesignerPlus 8

036 738 70 00 B3 B4 C D2 Ea^{1,2+4} Eb F2

Update for DesignerPlus 5-7

036 738 70 01 B3 B4 C D2 Ea^{1,2+4} Eb F2

Upgrade for EditorPlus 5-7

036 738 70 02 B3 B4 C D2 Ea^{1,2+4} Eb F2

Education (5 individual licenses)

036 738 70 04 B3 B4 C D2 Ea^{1,2+4} Eb F2

30-day Trial version (DVD)

036 738 70 05 B3 B4 C D2 Ea^{1,2+4} Eb F2

BERNINA Embroidery Software 8 – even more creativity in 3D

BERNINA Embroidery Software 8 provides you with a wide range of unique features and 3D effects for creative embroidery with an individual touch. A 30-day trial version of the Software is also available as a free download.

The Software comes with a USB stick and a card with a product key that replaces the dongle of previous versions. The USB stick is used to install the software, which must then be activated by the product key.

The USB stick consists of two parts: one takes care of the installation, is write-protected, and hence appears in Windows Explorer as the CD drive. The other serves as removable media, and can be used to transfer data such as embroidery motifs to your embroidery machine.

BERNINA Embroidery Software 8 is activated online using the product key. The licensing agreement, which must be accepted before completion of installation, allows the user to activate the software on two different computers. A third activation option is also held in reserve for a new computer replacing an old one.



Scan the QR code to see a video tutorial.

CorelDRAW[®] SE

Graphics Suite

Edit your photos and designs in Corel (Artwork Canvas Mode) and convert them directly into an embroidery motifs (Embroidery Canvas Mode).



Use this digitizing software with Windows 7-10. The window is scaled automatically to standard or 4K screen resolution. When using 4K monitors, increase the scaling factor to improve icon recognition.



Color PhotoStitch

Convert a favourite snapshot of your four-legged friend into a photorealistic, detailed embroidery motif. The new automatic digitizing lets you accomplish this in just a few simple steps and embroider the result on your BERNINA embroidery machine. Simply choose the colour and size, and the Software will do the rest.

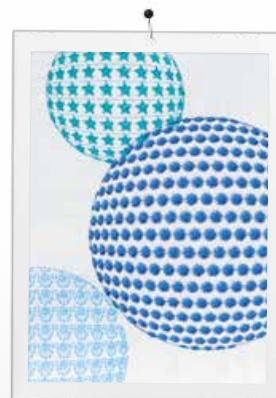

3D-Globe Effect

Create stunning 3D globe effects! The Software turns flat embroidery into deceptively realistic-looking 3D embroidery motifs.

Couching

Embellish your embroidery with brand-new effects with the addition of woollen yarns and cords. These will stand out in relief when couched, giving your creations a very special 3D look.



BERNINA Toolbox



Lettering Basic

101 425 70 01 B4 (555/570/630) C2 (730) C3 (560/580/640) D2 Ea^{1,2+4} Eb F2

Editing

101 425 70 00 B4 (555/570/630) C2 (730) C3 (560/580/640) D2 Ea^{1,2+4} Eb F2

Lettering

101 425 70 02 B4 (555/570/630) C2 (730) C3 (560/580/640) D2 Ea^{1,2+4} Eb F2

Monogramming

101 425 70 03 B4 (555/570/630) C2 (730) C3 (560/580/640) D2 Ea^{1,2+4} Eb F2

Bundle

101 425 70 04 B4 (555/570/630) C2 (730) C3 (560/580/640) D2 Ea^{1,2+4} Eb F2

30-day trial version

101 425 70 05 B4 (555/570/630) C2 (730) C3 (560/580/640) D2 Ea^{1,2+4} Eb F2

BERNINA Toolbox – The right tool for every embroidery project

Ideal for those first steps in embroidery, the BERNINA Toolbox Software will wow you with its simplicity and intuitive operation. It offers a wide range of embroidery motifs and lettering options.

The BERNINA Toolbox consists of individual modules that can be combined as wished, depending on your intended application. The software can be installed on computers running on either Mac or Windows operating systems.

You'll find the embroidery motif library in the BERNINA Cloud, the web service where embroidery motifs are displayed, saved and edited. The website <http://www.berninacloud.com> gives you access to the contents of the Toolbox via your PC, smartphone or tablet, letting you edit embroidery motifs any time, anywhere. To embroider the motifs, simply download them in the desired embroidery format.

In principle, the BERNINA Toolbox can be installed on any number of devices, although the software may be used simultaneously on no more than two. The software licences are easy to activate and deactivate, allowing for flexible use.

A 30-day trial version is available for free download at www.bernina.com/toolbox-trial. After expiry of the trial period you may continue to use Toolbox for free, but with restricted use of the functions. Users can then purchase individual modules suited to their specific needs.



Add and edit lettering



Edit embroidery designs



Modify and design lettering



Personalization



All-in-one!



Free 30-day trial version

BERNINA DesignWorks Software Suite



034 275 71 00 B4 C2 C3 D2 Ea^{1,2+4} Eb F2

BERNINA DesignWorks Software codes

PaintWork	034 229 71 00	B4 (555,570)	C3 (560,580)	D2	Ea ^{1,2+4}	Eb	F2
CutWork	034 229 71 01	B4	C2 C3	D2	Ea ^{1,2+4}	Eb	F2
CrystalWork	034 229 71 02	B4 (555,570)	C3 (560,580)	D2	Ea ^{1,2+4}	Eb	F2
CutWork update	034 229 71 03	B4 (555,570)	C3 (560,580)	D2	Ea ^{1,2+4}	Eb	F2

BERNINA DesignWorks tools



PaintWork	033 692 71 00	B4 (555,570)	C3 (560,580)	D2	Ea ^{1,2+4}	Eb	F2
CutWork	034 276 72 00	B4	C2 C3	D2	Ea ^{1,2+4}	Eb	F2
CrystalWork	034 273 72 00	B4 (555,570)	C3 (560,580)	D2	Ea ^{1,2+4}	Eb	F2

BERNINA CrystalWork materials

CrystalWork starter kit	034 374 70 00*	B4 (555,570)	C3 (560,580)	D2	Ea ^{1,2+4}	Eb	F2
CrystalWork template material	034 375 70 00*	B4	C2 C3	D2	Ea ^{1,2+4}	Eb	F2
CrystalWork adhesive film	034 374 70 00*	B4 (555,570)	C3 (560,580)	D2	Ea ^{1,2+4}	Eb	F2

* While stocks last

Straight- and CutWork stitch plate

033 339 72 00	B1 (210–380)	B4	B5
033 339 73 13	C3		
033 339 71 07	D	Ea ³⁺⁴	Eb ³⁺⁴
008 865 71 03	C1	C2	
033 339 70 14	Ea ²	Eb ²	
034 914 70 00	F		

BERNINA DesignWorks spare parts

CutWork needles	033 375 71 00	B4	C2 C3	D2	Ea ^{1,2+4}	Eb	F2
CrystalWork punching die set	034 343 70 00	B4 (555,570)	C3 (560,580)	D2	Ea ^{1,2+4}	Eb	F2

Creativity in three new dimensions

Now you can cut shapes, paint colourful designs and create glittering crystal appliqués with a BERNINA sewing and embroidery machine. Use the techniques separately or in combination to explore new dimensions of creativity. Three unique accessories plus a modular software package turn your BERNINA embroidery machine into a creative multimedia machine.

The BERNINA DesignWorks Software Suite includes all three modules: CutWork, PaintWork and CrystalWork. Upon installation of the software, each module is activated through an access code specific to that module. Modules may be purchased individually or in combination. Each module of the BERNINA DesignWorks Software Suite contains 744 stitches and over 40 designs to get you started on your creative adventure.

Please note that the sewing tools and accessories for use with the BERNINA DesignWorks Software are available separately.

The BERNINA CutWork Software and the relevant tools and accessories are compatible with the following BERNINA embroidery-machine models: artista 200/630/640/730, aurora 430/435/450.



Scan the QR code to see a video tutorial.







Accessories for
Overlockers/Sergers

Category A

BERNINA 009DCC
BERNINA L 220

**Category B**

BERNINA 700D
BERNINA 800DL
BERNINA 870D
BERNINA 880DL

**Category C**

BERNINA 1100D
BERNINA 1100DA
BERNINA 1110D

**Category D**

BERNINA 1000DA
BERNINA 1200DA
BERNINA 1300DC

**Category E**

BERNINA 1150MDA
BERNINA 1200MDA
BERNINA 1300MDC

**Category F**

BERNINA L 450
BERNINA L 460



General sewing

Standard presser foot



502 010 72 05	B
502 010 54 53	C
502 010 75 49	D (1000DA/1200DA) E (1150MDA/1200MDA)
502 010 70 20	D (1300DC) E (1300MDC)
502 070 03 97	F

Suitable for most overlocking projects where the fabric edge is cut and neatened in a single operation. The presser foot is equipped with an adjustable open tape guide.



Chainstitch foot



502 010 52 41 A

The Chainstitch foot improves fabric feed when chainstitching. It is perfect for seams on layers of fabric of the same height, or for sewing flat fabric.

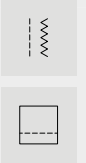

Hems and topstitching

Coverstitch/Compensating foot



502 010 76 27	A (L220)
502 010 52 16	A (009DCC)
502 010 70 38	D (1300DC) E (1300 MDC)

For seams, hems, bindings and decorative stitching over uneven layers of fabric. The spring-loaded sides of the foot guide the fabric when sewing binding, hems with elastic, or narrow topstitching.



Elasticator foot

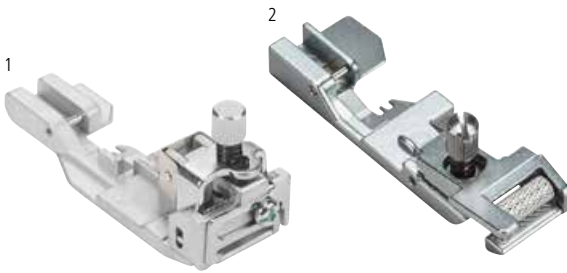

1 502 010 64 59	B C D E
2 502 070 03 50	F

The Elasticator foot guides and stretches the elastic as it is being sewn on. Ideal for lingerie, swimwear, sportswear and home textiles.



Scan the QR code to see a video tutorial.

Blindstitch foot

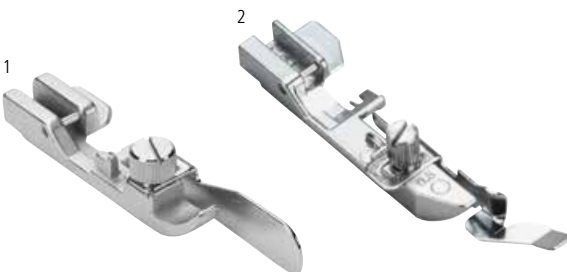

1 502 010 64 58	B C D E	universal
2 502 070 03 48	F	0.5mm
2 502 070 03 49	F	1.0mm

The adjustable guide plate on the side makes it easier to stitch blind hems. The Blindstitch foot can also be used for flatlocking folded edges and for heirloom techniques. The 0.5mm foot is suitable for fine and medium-weight fabrics, whilst the 1.0mm foot is ideal for medium-weight and heavy materials.



Hem guide



502 010 68 87* A (009DCC) D (1300DC) E (1300 MDC)
502 010 77 22 A (L220)

* While stocks last

The hem guide ensures even, parallel feeding of pre-folded fabric. Particularly suitable for hems on shirts and dresses made from stretch and highly elastic fabrics.

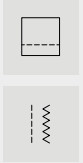

Decorative sewing

Multi-purpose foot with guide



502 010 64 61	B ¹ C D	Foot with guide
502 010 70 96	E	Foot with guide
502 010 07 70	B C D E	Foot
502 070 03 51	F	Foot
502 010 07 72	B ¹ C D	Guide
502 010 71 00	E	Guide

¹ With Accessory mounting bracket 502 010 54 11 only

The guide groove guides the piping as it is being made and sewn in. The open guide channel facilitates the sewing-on of strings of beads and sequins.



Scan the QR code to see a video tutorial.

Cording foot

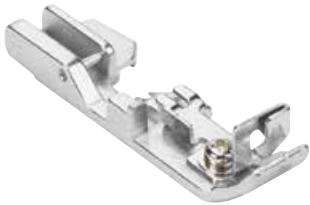

502 010 64 60	B C D E
----------------------	---------

The Cording foot is used e.g. for sewing thin cord, wire, fishline, perle yarn or fine yarn into a rolled hem. Ideal for reinforced edges, decorative ruffles and shapeable knitted bands.



Gathering foot

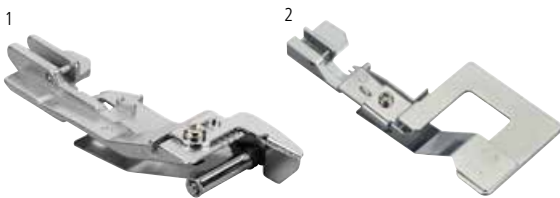

1	502 010 68 82	B C D E
2	502 070 03 52	F

The fabric to be gathered is positioned underneath the gathering attachment, whilst the fabric that remains flat passes over it. The fabric is gathered by differential feed at the same time as it is sewn onto the flat fabric.



Scan the QR code to see a video tutorial.

Gathering attachment



502 010 64 67 B¹ C D
502 010 70 95 E

¹ With Accessory mounting bracket 502 010 54 11 only

The tab on the attachment separates the two layers of fabric. The bottom layer is gathered whilst the top layer remains flat. You can simply gather a length of fabric, or gather the fabric whilst simultaneously sewing it onto a flat piece of fabric.



Decorative-thread guide



502 070 03 55 F

This guide is ideal for sewing wide seams and hems with decorative threads. Because the thread-tension unit is bypassed, little or no tension is applied to the decorative thread.



Decorative-thread spool pin



502 070 03 56 F

This horizontal spool pin holds parallel-wound flanged spools and conventional household spools of decorative and metallic thread. Lying on its side, the spool is unrolled rather than unwound, which prevents the threads from twisting.



Other accessories

Right and left seam guide

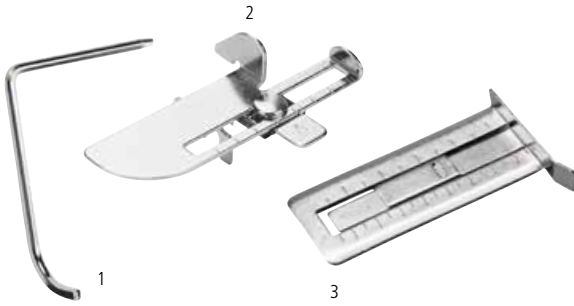

1	502 010 06 81	A B C D E	left
2	502 010 65 99	B' C D	right
2	502 010 70 97	E	right
3	502 070 03 53	F	right

¹ With Accessory mounting bracket 502 010 54 11 only

The right seam guide helps to guide the fabric and ensures that it is cut evenly. The left seam guide is ideal for sewing parallel lines of overlocking, coverstitching and chainstitching.



Extension table



502 070 03 57 F

The Extension table increases the sewing area to the left of the needle. It allows large fabrics to be guided more easily and gives a better overview of the sewing project.



Cut-offs bin

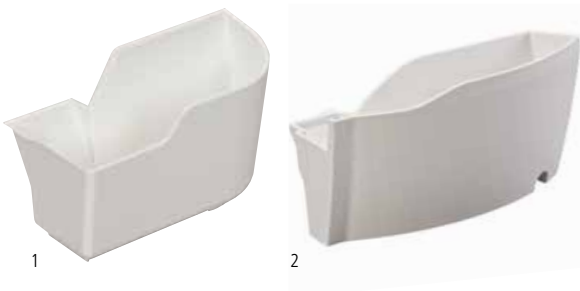

1	502 010 66 88	B
1	502 010 65 79	C D E
2	502 070 03 58	F

The Cut-offs bin keeps the sewing table tidy. Simply click it on to the looper cover and dispose of fabric waste immediately after cutting. It can also be used to store the foot control.



BERNINA tweezers



031 564 50 00 A B C¹ D¹ E¹ F¹

¹ Does not fit in the accessories holder in the looper cover.

BERNINA tweezers allow you to thread your overlocker with ease and remove any remaining pieces of thread from the machine.



Needle threader/inserter



1 502 070 03 69 A B C D E¹ F

2 502 010 70 44 E

¹ Does not fit in the accessories holder in the looper cover.

The needle threader/insertor makes it easy to hold, insert and thread overlocker needles.



Brush/Needle inserter



1 502 010 72 47 A B C D E with needle inserter

2 502 070 03 63 F

This tool helps you remove dust and lint from the looper and stitch-plate area. One of the two variants also holds the needle in place during insertion.



Screwdriver



The screwdriver makes changing needles simplicity itself.

1	502 010 76 46	A (L220)	1.5mm hex
2	502 010 06 80	A (009DC) B C D E	slot
3	035 987 50 00	F	1.5mm hex

Spool stabilizer



The spool stabilizer prevents spools and cones of various sizes from vibrating at both slow and fast sewing speeds.

1	502 010 08 75	A B C D E
2	502 070 03 60	F

Accessory mounting bracket



The Accessory mounting bracket is essential for attaching overlocker accessories to the Funlock, 300 Series, 700D and 800D/DL models.

502 010 54 11	A B C
----------------------	-------

Accessories box



502 070 03 65 A B C D E F

The Accessories box can be used to store overlocker presser feet and other accessories. Please note that the Accessories box is supplied empty.



Carrying case for overlockers/sergers



502 010 72 00 A B C D E F

Keep your overlocker in tip-top condition when traveling, and protect it when not in use.



BERNINA E 16 multi-needle embroidery machine

Professional Embroidery

The perfect partner for home, studio or business

With 16 needles, speeds of up to 1,400 stitches per minute (spm), automatic tension settings, and a narrow cylindrical arm, the BERNINA E16 will complete the task like a pro, whether embroidering a jacket back or small pocket. Personalize team uniforms and caps, monogram stylish totes, commemorate a special occasion, use the Chenille technique for a special 3-D effect, or complete an elaborate embroidered quilt—the results will be everything you ever dreamed of.



More information on www.bernina.com/multineedle
Not all products and models are available in all countries.

Professional Quilting

BERNINA Q20 / Q24
longarm quilting machines

Introducing *BIG*

The BERNINA Q20 and Q24 Longarm machines embody the dream of creating a machine simple enough for a beginner to master, yet robust enough for the professional.

Dream *BIG*

BERNINA is excited to share with you the fulfilment of a vision that was 120 years in the making. A long history of innovation and a wealth of quilting expertise have been combined in a machine that will meet the demands of discerning quilters everywhere. From the very first stitch, you will appreciate the thought behind every detail. Confidently finish your large quilt projects, explore art-quilting, or enter a quilt competition. BERNINA is the perfect partner for home or studio.

More information at www.bernina.com/longarm
Not all products and models are available in all countries.



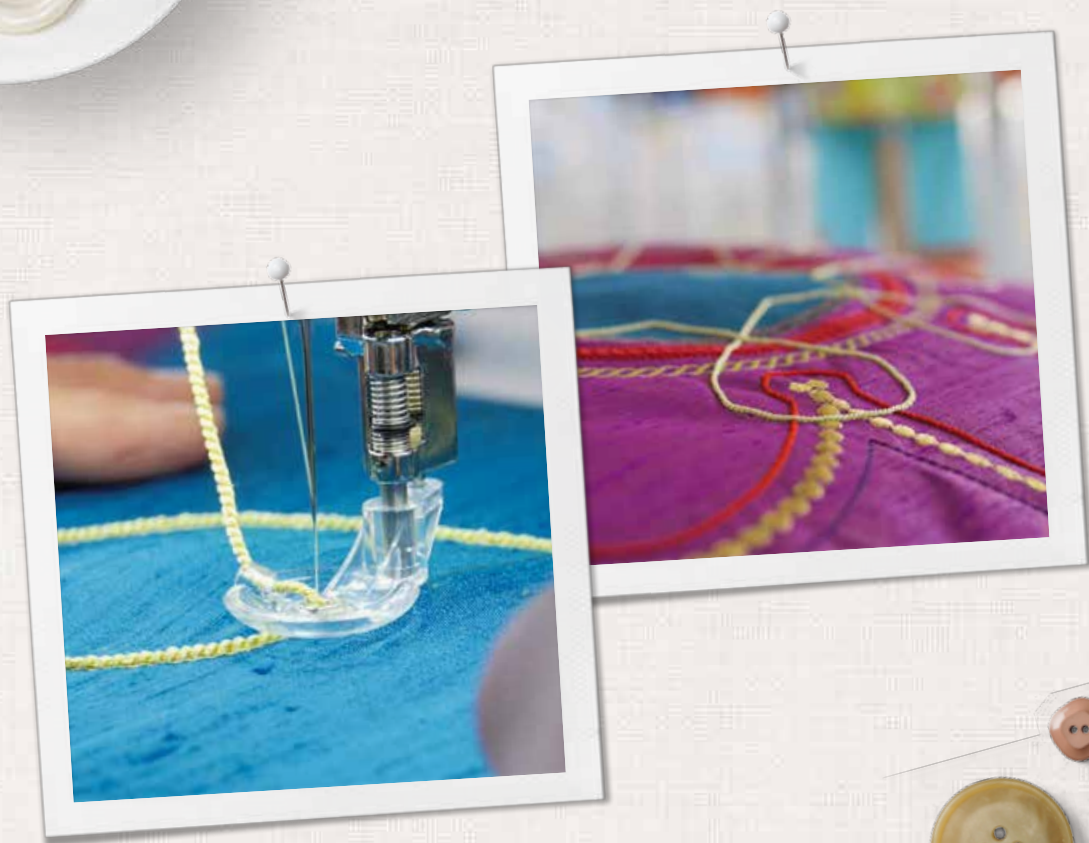

Not all accessories are available in every country. Product range and the functions and features of individual products are subject to change without prior notice. For more information, visit www.bernina.com, or consult your BERNINA dealer.

