

# **BERNINA**

**Model 730, Bernina-Record**

Automatic Zigzag Sewing Machine  
with automatic ornamental stitch device

**Model 731**

Automatic Zigzag Sewing Machine  
with automatic ornamental stitch device

**Model 732**

Automatic Zigzag Sewing Machine  
without automatic ornamental stitch device

**FR. GEGAUF LTD. BERNINA SEWING MACHINE FACTORY  
STECKBORN / Switzerland**

## Table of Contents

	Page		Page
Guarantee .....	1	Gathering the Material .....	39
Removing and replacing of machine .....	5	Automatic Buttonhole Sewing .....	40
Electric part .....	10	Buttonhole with Cord Inlay .....	45
Bobbin case and bobbin .....	12	Buttonhole Sewing without Automatic .....	46
Spooling the Under Thread .....	12	Darning with Wool .....	48
Threading the Under Thread .....	14	Appliqué Work .....	50
Needle and Thread .....	15	Ornamental Stitches without Automatic .....	51
Threading the Bobbin Thread .....	16	Satin Stitch Stop .....	52
Fixing the Slide-on Table .....	18	Automatic Ornamental Stitches (only applicable to Model 730) .....	53
Cleaning and Oiling .....	19	Adjustment for Automatic Ornamental Stitch Sewing .....	56
Plain Stitch .....	22	Blindstitch Sewing .....	57
Forward and Backward Sewing .....	23	Tucking .....	59
Darning .....	24	Hemstitch Sewing .....	62
Feller .....	26	Embroidering Initials .....	67
Hemmer .....	27	Eyelet Embroidery .....	69
Gathering Foot .....	28	Common Causes of Machine Troubles; how to avoid them .....	72
Edger .....	29	Accessories for Class 730 .....	79
Zipper Sewing Foot .....	30	Accessories for Class 731 .....	80
Zigzag Sewing .....	32	Accessories for Class 732 .... Third Inside Cover	
Elastic Sewing of Knitted Goods .....	34		
Elastic Side Seam for Knitted Goods .....	37		
Sewing on Lace; Roll Hemmer .....	38		

**BERNINA**

## CERTIFICATE OF GUARANTEE

for the BERNINA Sewing Machine

Model 730/731/732 No.  

(Please quote in all your correspondences)

.....  
.....

### Validity of Guarantee

Terms of guarantee  
overleaf

(This certificate should  
be signed on the basis of  
the terms listed overleaf,  
only after instructions  
have been given)

Machine: Five years, thus until .....

Motor: Two years, thus until .....

City and date: .....

Signature of Agent: .....

**FR. GEGAUF LTD. BERNINA Sewing Machine Factory STECKBORN / Switzerland**

## **Terms of Guarantee**

We engage to repair, free of charge, any defects due to faulty material and/or workmanship arising during five years in the machine, and during two years in the motor of the BERNINA Model 730, 731 or Model 732 Sewing Machine supplied by us. All other claims are excluded from this Guarantee, which is valid only towards the first buyer of the machine.

This Guarantee becomes valid on the day of the delivery of the machine. A buyer wishing to claim under the Guarantee should return the machine to the BERNINA representative next to his domicile. Transport charges as well as any damage caused by faulty packing are at the buyer's expense.

This Guarantee does not cover normal wear and tear, nor any damage ensuing therefrom, such as cable breaking, burning out of electric bulb a.s.o.

This Guarantee does not apply if the buyer does not treat the machine in the right way, as indicated in the instructions for use, if the machine is not properly cleaned and lubricated, nor in the right way, if third persons not appointed by us are allowed to effect alterations and/or repairs.

Damages due to faulty manipulations are not covered by this Guarantee.

The Guarantee is only valid if high-grade sewing machine oil and needles of the System no. 705 are used.

**FR. GEGAUF LTD.    BERNINA SEWING MACHINE FACTORY    STECKBORN / Switzerland**

**Buyer  
of Machine**

Name and Surname: .....

Street: .....

Town: .....

Date of Delivery: .....

.....  
(Signature of Buyer)

.....  
(Stamp of the firm)

**Supplier  
of Machine**

.....  
(Signature of Supplier)

Notes of BERNINA Representative  
regarding instructions, home calls, and possible warranty work

Date	Notes

*This Instruction-Book is applicable for both Models 730, 731 and 732, with the exception of «Automatic Ornamental Stitches» on page 51.*

To unpack the machine, put the carrying case in upright position upon a table and open the case as you can see in Fig. 1. Grip the machine on its upper arm and take it out from the case.

When putting the machine again away into the case, be careful about the correct position of the handwheel, as otherwise the carrying case cannot be closed. There is a drawing on the inside bottom of the case, showing how to place the machine in the right manner. After receipt of machine it will be advisable to keep the packing material which is adequate, in order to have it at hand, ready for use at any time, if the machine should be sent by public transport means.

## Removing and replacing

Fig. 1



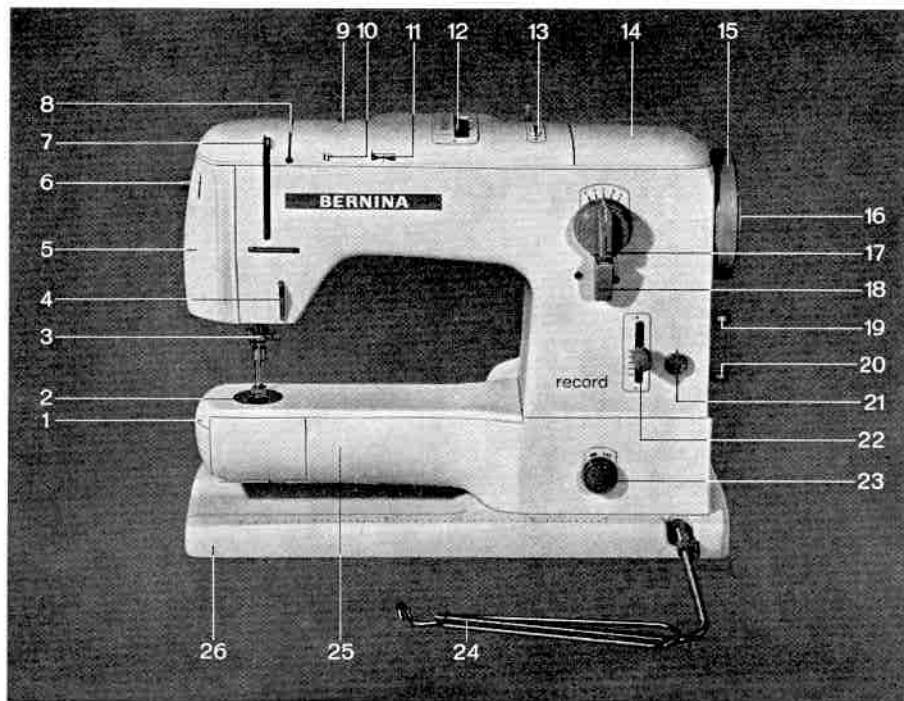

Fig. 2



Fig. 2 shows a BERNINA-Record Sewing Machine, Model 730 (knee operated). The controls referred to in the Operating Instructions being marked and indentified.

- |                                   |   |   |
|-----------------------------------|---|---|
| 1 Cover plate                     | 11 Sight hole for ornamental stitch control                   | 19 Closing push-button for buttonhole device  |
| 2 Needle plate                    | 12 Switch lever for ornamental stitch selection               | 20 Closing button for satin stitch stop   |
| 3 Needle holder                   | 13 Change lever for zigzag or ornamental stitch               | 21 Knob lever for adjusting closeness of stitches with buttonholes and satin stitch seams |
| 4 Thread tension regulator        | 14 Flap-plate covering spooling device                        | 22 Stitch length regulating lever   |
| 5 Face plate                      | 15 Handwheel  | 23 Drop feed knob   |
| 6 Light switch                    | 16 Handwheel release  | 24 Knee control lever   |
| 7 Take-up lever                   | 17 Needle displacement lever (left - medium position - right) | 25 Free arm   |
| 8 Thread tension and thread guide | 18 Plain stitch, zigzag, and buttonhole sewing control knob   | 26 Bed Plate  |
| 9 Thread tension control plate    |   |   |
| 10 Sight hole for tension control |   |   |

Fig. 2a shows a BERNINA Sewing Machine, Model 731 (knee operated). The controls referred to in the Operating Instructions being marked and identified.

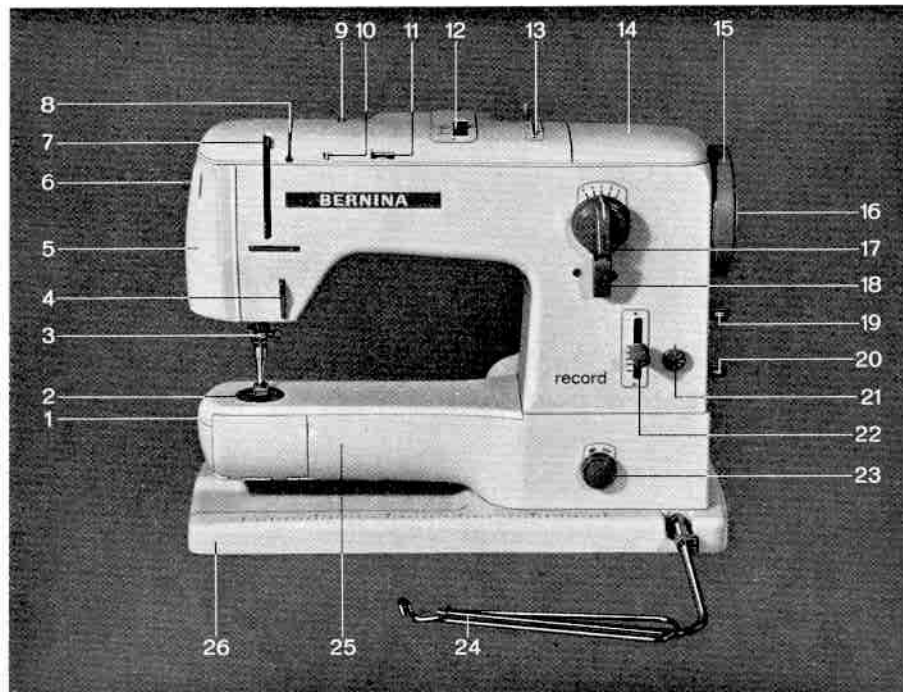
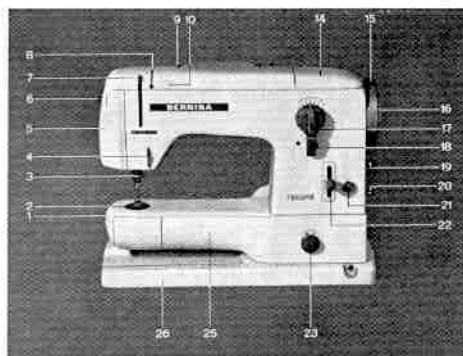

Fig. 2a

- |   |   |
|---|---|
| <b>1</b> Cover plate  | <b>15</b> Handwheel   |
| <b>2</b> Needle plate                                       | <b>16</b> Handwheel release   |
| <b>3</b> Needle holder                                      | <b>17</b> Needle displacement lever<br>(left - medium position -<br>right)                                |
| <b>4</b> Thread tension regulator                           | <b>18</b> Plain stitch, zigzag, and<br>buttonhole sewing control<br>knob                                  |
| <b>5</b> Face plate   | <b>19</b> Closing push-button for<br>buttonhole device  |
| <b>6</b> Light switch                                       | <b>20</b> Closing button for satin<br>stitch stop   |
| <b>7</b> Take-up lever                                      | <b>21</b> Knob lever for adjusting<br>closeness of stitches with<br>buttonholes and satin<br>stitch seams |
| <b>8</b> Thread tension and<br>thread guide                 | <b>22</b> Stitch length regulating<br>lever   |
| <b>9</b> Thread tension<br>control plate                    | <b>23</b> Drop feed knob  |
| <b>10</b> Sight hole for tension<br>control                 | <b>24</b> Knee control lever  |
| <b>11</b> Sight hole for ornamental<br>stitch control       | <b>25</b> Free arm  |
| <b>12</b> Switch lever for orna-<br>mental stitch selection | <b>26</b> Bed Plate   |
| <b>13</b> Change lever for zigzag<br>or ornamental stitch   |   |
| <b>14</b> Flap-plate covering<br>spooling device            |   |

Fig. 3 shows a BERNINA Sewing Machine, Model 732 (knee operated), whereon the controls referred to in the Operating Instructions are marked and identified.

Fig. 3



## Electrical part

The drive of the BERNINA-Record, Model 730 (731/732), is functioning by the universal motor mounted at the rear. With knee lever operated machines motor and rheostat control are concealed beneath the protective housing. With pedal operated machines only the motor appears under this cover and is

Fig. 4

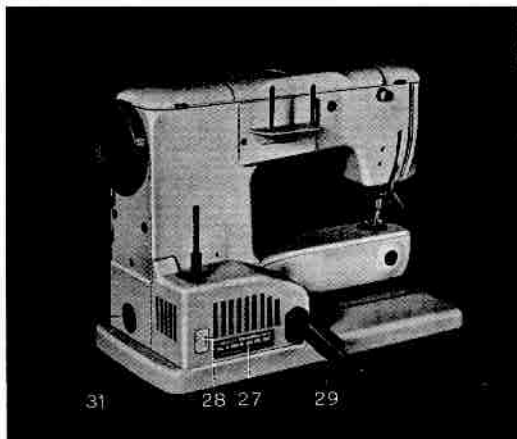

connected with a socket for the plug of the pedal starter. This protective housing bears a so-called rating plate 27 specifying the voltage and power of the motor.

Moreover, on the housing which conceals the motor a switch 28 is visible. If the knob of this switch is pushed upwards as far as possible, the machine can be adjusted with the whole amount of stitches.

With the knob pushed downwards as far as it will go, the machine runs only about half its speed and the amount of stitches can be adjusted within this range. This device has been provided for being able to sew with reduced speed.

Prior to connecting the flex 29 to the mains, make sure that the voltage indicated on the rating plate corresponds to the mains voltage. The mains voltage is indicated on the electric meter of your home, or on an incandescent lamp on the spot where it is used. This must always be checked, particularly if the machine is to be used away from home. Do not rely on the number of volts indicated on plugs and sockets.

After having connected the cord extension 29 with the plug of the mains and in case of machines with pedal starter also starter 30 with socket 31, start machine by exerting slight pressure against knee control lever 24 with your knee, respectively in the case of pedal starter machines by a slight pressure on the tread thereof. The farther the knee starter lever 24 is pressed to the right, respectively the

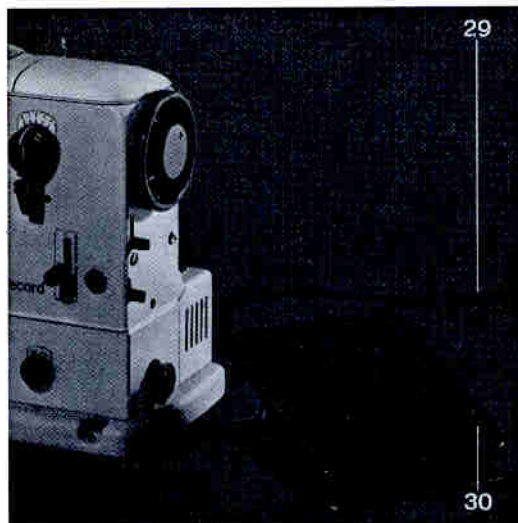

Fig. 5

tread plate downwards, the greater the speed of the machine.

Practise speed control several times without threading the machine.

The lamp is mounted in the swivelled head cover to enable an even distribution of light over the entire sewing area, completely free from any glare.

It is switched on and off by pressing the light button 6. The bulb can be changed as is usual with the current lamps. Turn it to the left to remove, and to the right to insert.

### Care of the motor

#### *a) Lubrification*

The motor has friction bearings, by means of which a nearly silent running can be obtained. The bearings are automatically lubricated, so that they need no service at all.

#### *b) Carbon brushes*

From time to time the length of the carbon brushes should be controlled. To this intent first the motor cover must be screwed off (Remove the mains plug!). Now the upper carbon brush support becomes visible. After having screwed off the cap, the collector carbon can be drawn out. The collector carbon opposite to the carbon brush is accessible through the borehole at the underside of the bed plate. Here too the carbon holder cap is screwed out and the carbon brush removed. If these carbon brushes are not renewed in due time – with a minimum length of 3 millimeters – they will damage the collector and soon the motor can no more be used. When re-inserting the carbon brushes please take care that the ground rounding which must match with the rounding of the collector is not introduced wrongly.

## Bobbin Case and Bobbin

### Removal of Bobbin Case

Turn the handwheel until the thread take-up lever 7 (fig. 2) is raised approximately to its highest position and with the forefinger of the right hand open

Fig. 6



the hinged shuttle-cover 32 of the free arm. Now you get free access to the bobbin case. With the forefinger of the left hand open the latch 33 of the hinge and withdraw bobbin case with bobbin (fig. 6). Let go latch 33, which frees the bobbin, allowing it to fall out of the bobbin case.

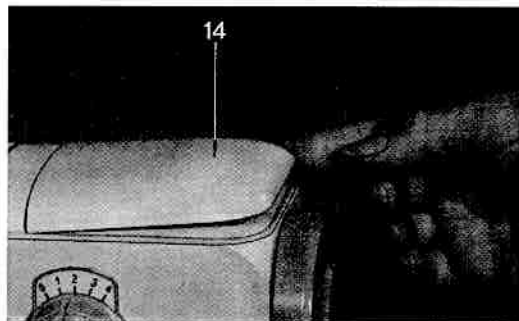

Fig. 7

### Spooling the Under Thread

The winding of the bobbin bearing the under thread, with BERNINA of the Models 730, 731 and 732, is done with an automatic winder. It is placed below the hinged cover 14 which is connected in a hinged way with the head cover of the frame (see fig. 7).

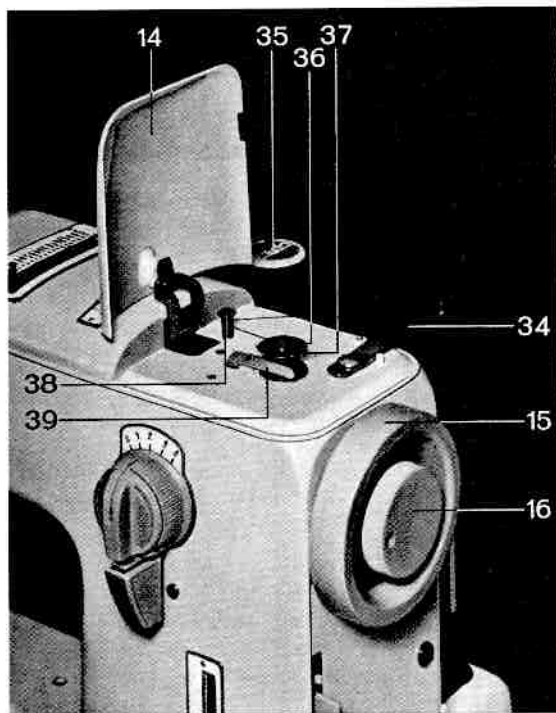

Fig. 8

For winding the cover 14 is turned upwards and the lever 34 carrying the winding device is swivelled out towards backside onto the stop (fig. 8).

A more perfect stitch is obtained if the under thread is chosen somewhat finer than the one used for upper thread. The reel from which the winding has to be done is placed onto one of the two reel-pins 35.

In order to prevent the whole machine from running needlessly when winding, turn with your right hand the handwheel release screw 16 as far as possible towards you, at the same time holding the handwheel 15 firmly with your left hand.

Place the bobbin 37 onto the bobbin shaft 36 projecting from the hinged cover. The threading is done as follows: First lead the thread from the reel to the winder pretension device 34, and from here around thread guide bolt 38 to the bobbin 37. The thread should wind in clockwise direction. Now push lever 39 towards the bobbin until it gets engaged.

Then the motor can be started by a slight pressure on the knee lever, respectively on the pedal starter, the mechanism being still at rest. Operate the machine until the bobbin is filled, whereupon the winder will stop automatically. When the filled bobbin has been taken off, lever 34 with winder pretension device has to be turned in and hinged cover 34 can be returned to its starting position.

Tighten handwheel release screw 16 again.

**Inserting the bobbin into the case and  
threading the under thread  
Replacing bobbin case with bobbin into shuttle**

When replacing bobbin into case, make sure that bobbin turns in direction of arrow when thread is pulled (see fig. 9).

After insertion of bobbin pass thread through slot 27, below tension spring 28, and allow it to come out at the end of tension spring 29.

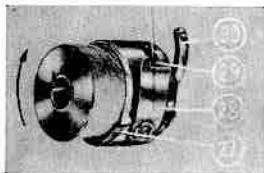

Fig. 9

Insertion of bobbin case is possible only when the needle is in its uppermost position. The bobbin case is held by the opened latch 33, same as when removing it (fig. 6). Thumb and forefinger of the left hand hold the hinged latch so that the bobbin case finger 30 (fig. 9) points upward and can enter the

recess in the shuttle race cover. Then place the bobbin case on the shuttle pin until it strikes the bottom. Now release latch and make sure that it is properly closed.



Long groove  
facing you !



Fig. 10



## Needle and Thread

### Setting the needle

Use only System 705 needles. Needles with blunt points or bent needles should never be used. Turn handwheel towards you until the needle bar is at its highest.

Hold needle between thumb and forefinger of the left hand, so that the long groove *faces you!* The *flattened* end of the needle shank must therefore be *at the rear*. Now loosen the needle holder screw by turning it in anticlockwise direction and insert needle until it strikes above. Then tighten needle holder screw by turning it to the right. It is important that the needle should be pushed right up to the needle stop and be firmly clamped by the needle holder screw.

### Correct needle and thread selection

System 705 needles should be used exclusively on the BERNINA-Record, Model 730, 731 and 732. In order to obtain satisfactory results, use only these first class needles, as also highgrade thread.

First select the thread suitable for the intended work, and then the needle to accommodate the thread, using to this intent the table on the opposite page as a guide. The relation between needle and thread is correct if the thread, when placed in the long needle groove, fills this latter well and can be freely moved to and fro. For sewing the usual needle sizes are no. 80, 90 and 100 whereas for darning use needles of the sizes no. 70 and 80.

### Needle and Thread Table

Needle System 705	Sewing thread		Darning thread
	Six-ply (unglazed)	Three-ply (unglazed)	Two-ply
60	-	170-200	80-100
70	70-100	70-140	50-80
80	50-60	50-70	30-40
90	40-50	30-40	-
100	20-30	-	-

### Thread suitable for Sewing and Darning

For plain sewing: Nos. 60-90, 3- and 6-ply, unglazed  
For darning: Nos. 50-80, 2-ply  
For zigzag sewing: Nos. 60-90, 3-ply only  
For ornamental stitches: Nos. 30 and 40, 2ply

### Threading the Upper Thread (Fig. 11 and 12)

With BERNINA threading is done in one go from reel to needle.

Place a reel of thread on one of the two spool-pins situated at the back of the top arm (35). From there lead thread through the pre-tension 43, equally placed at the back of arm, then into slot running across top arm. In its centre the double thread tension 8 is

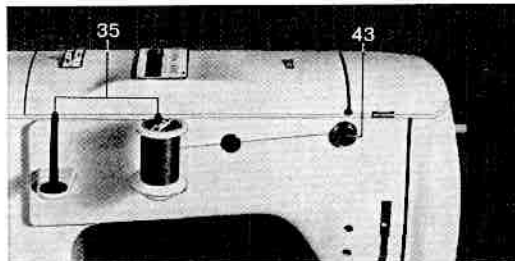

Fig. 11

arranged. The central tension disc is protruding somewhat from slot 44. When sewing with one thread only, it does not matter whether the thread is drawn at the left or at the right of the central tension disc into the tension properly speaking. At the front pass the thread down to thread regulator 4,

then up again through slot of take-up lever 7, and down once more through needle holder eyelet 45, and finally through needleeye itself from front to rear. When threading make sure that take-up lever 7 and needle are in their upmost position.

Fig. 12



### Thread tension (Fig. 13)

BERNINA offers the unique advantage that the thread tension must never be changed. Only two marked lines are provided for control. When the fixed marked line on top arm and the dot on mobile part of thread tension device are set one above the other, the perfect thread tension is attained. - With BERNINA sewing machines a numbered scale is not necessary.

By means of the adjusting disc 9 the thread tension can be changed for special purposes wished for. If the marked line is moving behind sight hole 10 to the right, the thread tension will be reinforced; if said marked line is moving to the left, the tension will be weaker. Correct normal tension is set when

Fig. 13

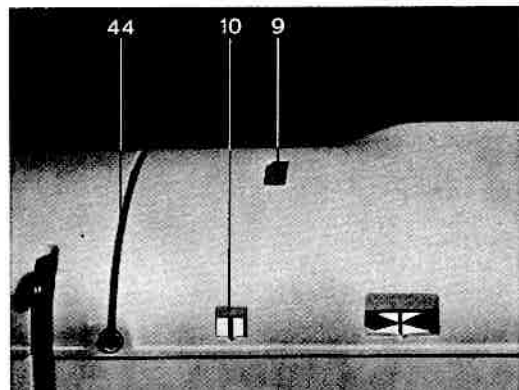

the mobile marked line is right above fixed marked line on sight hole.

### Drawing up the under thread (Fig. 14)

Before sewing can be started, the under thread should be drawn up. With thumb and forefinger of the left hand hold the end of the needle thread, leaving it slack from hand to needle. Turn handwheel with one single revolution towards you, until, protruding from the needle eye, the thread causes the needle lever to ascend to its highest position. Now draw a little bit the end of the needle thread, whereby the under thread will come through the stitch hole towards above. Tighten upper and under thread slightly and pass them backwards under the presser foot.

Fig. 14



### To fix the slide-on table (Fig. 15)

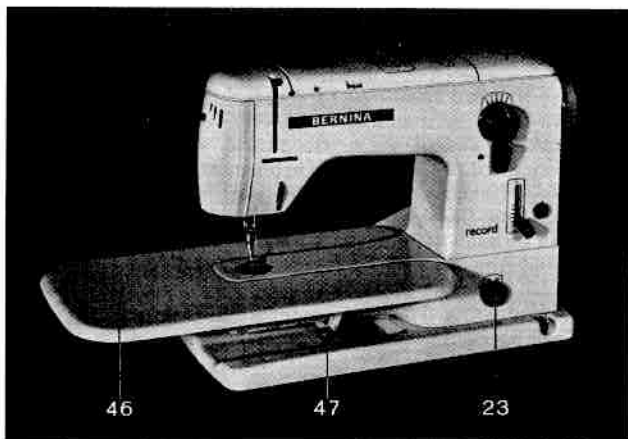

Fig. 15

The slide-on table 46 is accommodated in the rear of the carrying case and held on its wall by means of a bolt. Swivelling the bolt to the right will allow to remove the table.

When the sewing table is slid onto the free arm, make sure that locking lever 47 points to the right. In order to clamp the sewing table rigidly to the free arm, lever 47 is placed upright.

### To lower the feed dog (Fig. 16)

For certain sewing purposes, and mainly for darning, the feed dog should always be lowered. Below on the right of the machine a control knob 23 is provided, by means of which the feed dog can be brought out of action or set, ready for sewing. Marked signs on knob 23 are illustrating the actual position, whether the knob has been turned to the right for sewing or to the left for darning.



Fig. 16

### Thread cutter

The pressure foot holding device on the BERNINA Sewing machines is designed in such a way that it can also serve as thread cutter.

This small gadget helps to save time, especially when the scissors are not at hand.



Fig. 17

## Cleaning and Oiling

### To clean the machine

Fluff is collected during sewing, particularly around the shuttle. Such fluff may detrimentally affect the proper function of the machine and it is absolutely necessary to remove it frequently. From time to time remove cover plate 1 (see fig. 2), so that the fluff forming under the needle plate can be adequately removed.

The cover plate is accordingly designed for quick removal, so that cleaning and oiling can be carried through easily.

To remove the cover plate, open the hinged plate 32 of the shuttle and press the releasing lever 50 (see fig. 18) with the forefinger of the right hand. The presser foot itself need not be removed, but the needle should be placed in its uppermost position.

To insert the cover plate, move it up towards the stand and insert the plate tongue into the guide provided in the stand. Then depress the cover plate at its foremost point, where the needle plate lies, and the latch will engage automatically (fig. 19).

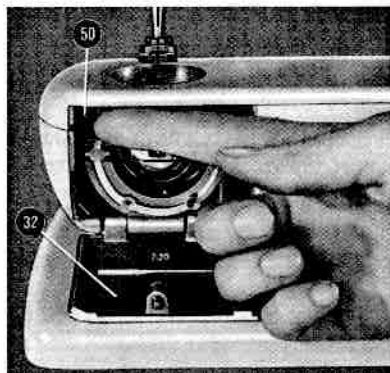

Fig. 18

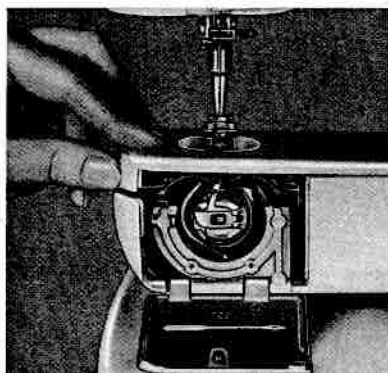
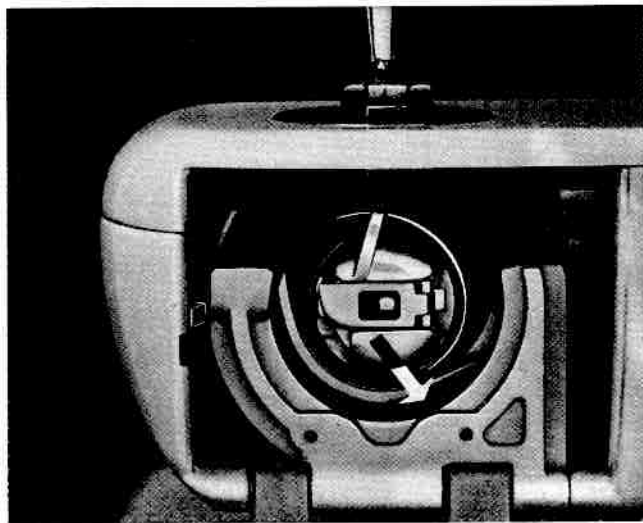

Fig. 19

## To oil the machine

Fig. 20



The sewing machine should be oiled frequently, but never too liberally. A few drops of oil are sufficient to keep the machine running freely. Oil in excess will drain off unused and may soil the fabric. Always oil your machine *before* sewing and not afterwards. Use clear oil which is free from resin and acid, such as is supplied by all the BERNINA representatives. The use of inferior oils may cause your machine to jam when the oil dries up and becomes tacky. The figures 20 and 21 show the oiling points indicated by a series of white lines.

When opening the hinged cover on the front of the free arm, you will have access to the shuttle of which the race should be oiled frequently – but only lightly – at the point indicated by an arrow on fig. 20.

*Expert oiling guarantees the silent running of the sewing machine and increases its durability.*

The oiling points not visible in the figures 20 and 21 are indicated with red colour on the machine itself.

When the machine has been kept in a cold room, it should be opened and placed in a warm room about an hour before use, so that it can assume room temperature and allow the oil in the bearings to become liquid again.

Fig. 21

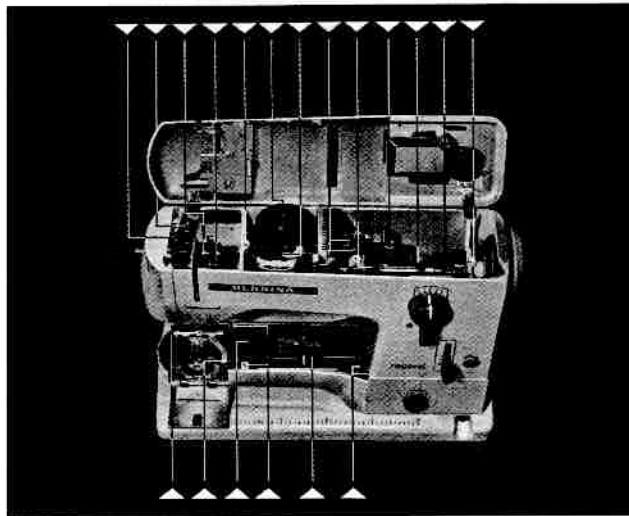

## Plain Stitch

### Plain Stitching with Standard and Special Presser Feet

#### Exchanging the Presser Foot

The different tasks of sewing work involve the necessity of frequent changes of the various presser feet. For this reason the BERNINA-Record, Models 730, 731 and 732, are equipped with the patented "Plug"-foot which can be connected as easily as

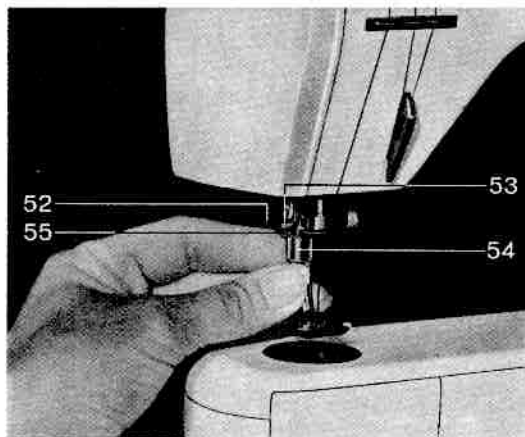

Fig. 22

an electrical plug. No screwdriver is needed and a reliable stability is guaranteed.

#### a) *To remove the presser foot* (fig. 22)

The presser bar with presser foot attached to it is raised with the lifting lever placed at the back of the head. Now raise clamping boss 53 of the presser foot 54 far enough for the hook 55 of the clamping lever 52 to release the clamping boss 53 completely. The presser foot will drop automatically or with very little assistance from the presser bar cone, so that it can easily be removed.

#### b) *When replacing the presser foot*

Push presser foot firmly onto the presser bar cone and fix now with the clamping lever 52.

### The plain stitch

For plain stitching adjust the machine as follows:

1. Raise thread take-up lever to its uppermost position.
2. Insert zigzag foot. If you intend to sew quite a lot of seams with plain stitching, it will be advisable to use the normal presser foot for plain stitches.
3. Thread the needle with upper thread from front to back through needle eyelet. Then draw up the under thread and lay both threads under and to the back of the presser foot.
4. Turn knob 23 to the right. Symbol to be put on "Sewing".
5. Unscrew stitch regulator device 22, the stitch regulator handle being developed as a turnable screw by means of which the stitch length can be ad-



justed by turning same in or out, and regulate the stitch length device on the wished for number. Normally this will be 1.5.

6. Set zigzag knob in such a way that the zero mark becomes visible on the stitch length dial above said knob.
7. Slide on sewing table.

Make sure that the handwheel is always turned towards the operator. (Same as fig. 15 on page 16.)

### **Forward and Backward Sewing and Adjustment of different Stitch lengths**

According to the position of the stitch regulator lever 22, the machine will sew forward or backward, form-

Fig. 23



ing long or short stitches. If the stitch regulator lever 22 is pushed down until the marked line is just below number zero at the left side of scale, the machine will sew forward. If the stitch regulator lever 22 is pushed upwards to just above number zero, the machine will sew backward. Forward and backward sewing serves to strengthen certain sewing areas and to secure the ends of the threads.

The more the stitch regulator lever 22 is displaced either upward or downward, the longer the forward or backward stitch will be.

In order to ensure that both forward and backward stitches will be of the same length, the lock screw of the stitch regulator lever 22 should be turned, respectively tightened or loosened. In this manner the upward and downward movement of the stitch regulator lever 22 can be limited. When loosening said screw the displacement of the lever will be increased, whereas in tightening same it will be reduced.

### **To remove the work from the machine**

Raise the thread take-up lever to its uppermost position and raise also the presser foot by means of the lifting lever. This will release the upper thread tension and the working piece can easily be removed without having to draw on the thread previously. In particular make sure that the material is always pulled from under and to the back of presser foot, to prevent the needle from becoming bent or causing thread breakage and faulty stitches.

## Darning

When the machine is set for darning and mending, proceed as follows :

1. Raise thread take-up lever.
2. Remove presser foot and insert darning or hopper foot.
3. Lower feed dog by turning knob 23 to the left upon "darning" symbol (see page 16).
4. Set stitch regulator lever 22 upon zero point to prevent the feed dog from being operated unnecessarily.
5. Adjust zigzag knob 18 upon zero position.

The BERNINA-Record, Models 730, 731 and 732, can be used for darning with or without the slide-on table, depending on the kind of material to be darned.

### Darning table linen, towels a. s. o.

Cut out the whole damaged spot, so that only solid material remains. Start as shown in fig. 24 a, in directing the work by hand, so that one thread comes to lie directly along the other. It will be useful to guide the threads about  $\frac{13}{64}$ " beyond the edge of the hole, but in somewhat different lengths altogether. This will strengthen the material round the hole, without giving a heavy darn.

Fig. 24

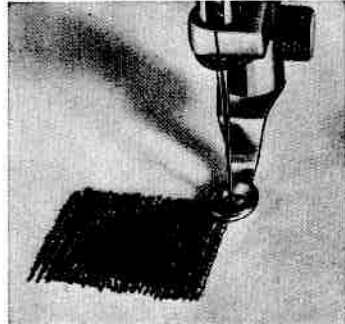
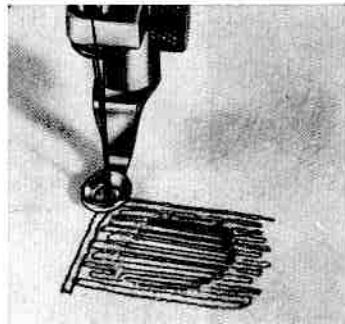
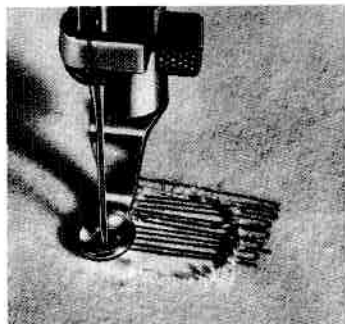

After the stitching has thus been completed, continue, as shown in fig. 24 b, to sew a second layer of threads across the first line of stitches, whereby you begin a bit outwards of the already stitched threads. This second layer should be a bit more covering.

Finally stitch a few more rows at equal distance apart, in order to fill gaps. This must be done in a very even manner (see fig. 24 c).

### Darning stockings

Darning stockings is rendered easy and especially convenient thanks to the BERNINA Darning Attachment. Its operation is indeed very simple.

Place the complete attachment for darning stockings on the free arm 25 and set the smaller stud at the shank end into the bore hole of the arm cover at 59. Then lift the inner ring 58 of the darning attachment off the outer ring by pressing the two finger tongues 60 together (see fig. 26). Now pull the stocking over the free arm and the darning apparatus, until the damaged area comes to lie in the middle of the darning ring.

It will be advantageous to slide the darning ring as far to the left as possible, in particular if the damaged area is at the top or heel. Then clamp the inner ring again into the outer ring now covered by the stocking (fig. 26), and make sure that the stocking area is uniformly tightened.

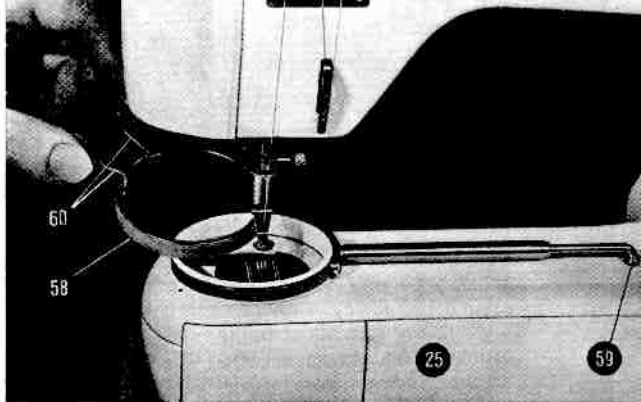
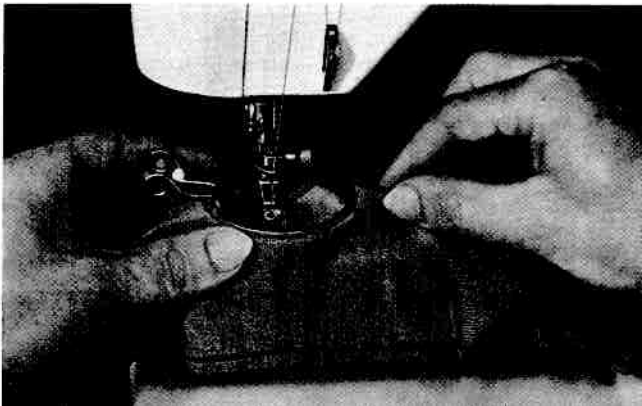

Fig. 25

Fig. 26



## THE FELLERFOOT

Press inner ring as far as it will go, so that the entire damaged area is lying uniformly on the needle plate. The damaged area now centered in the darning ring can easily be moved in any direction.

When beginning it will be useful to sew a full circle around the damaged area to prevent running. Then sew a line of stitches across the direction of the fabric stitches. The lines should be of different lengths and as close to one another as possible. This is done by sliding the darning ring to and fro. As soon as the hole is completely sewn over, cover these lines in the direction of the already knit stitches by moving the darning ring from left to right and vice-versa.

The inner ring can also be turned by one-quarter turn and the darning ring then again moved forward and backward. Start these covering lines somewhat beyond the outermost stitch lines (see fig. 24 b).

The covering lines, which should be of different lengths, must be disposed side by side in line with the fabric stitches. Now fill the small spaces in the mended area until the hole is uniformly covered.

In order to connect two pieces of material (linen, shirts a.s.o.) by means of a firm seam, the feller is used, whereby the felled seam is obtained in two operations.

### *1st operation (fig. 27)*

Arrange the fabric sections to be joined on top of each other, in such a manner that the bottom section slightly projects from the top one, and pass with

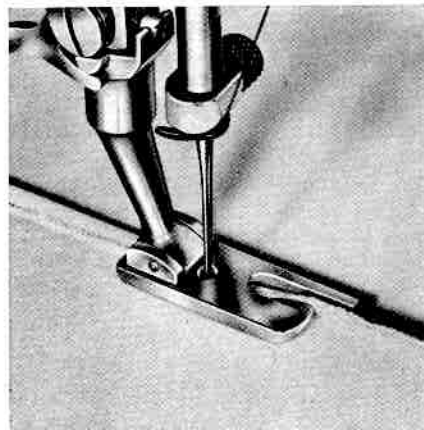

FIG. 27

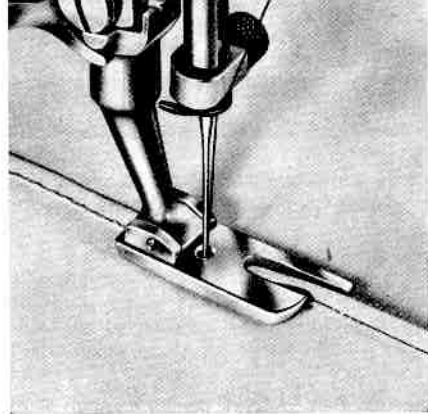

Fig. 28

sections touching both under the feller as when hemming, so that they fold over. Make sure that the same width of material always enters the feller.

*2nd operation (fig. 28)*

The two sections are now unfolded and laid flat, so that the seam formed stands up like a pleat. The pleat is again passed into the feller *in the same direction as was the case the first time*, so that it is folded over and can now be sewn down.

Fig. 29

## Hemmer

(Hem with a width of approximately  $\frac{3}{32}$ " )

Attach the hemmer in place of the ordinary presser foot, raising the presser foot bar for the purpose. Fold the edge of the material over to the desired hem width and guide the fabric into the spiral-type guide tongue of the raised hemmer as far as the needle, then lower the hemmer.

When sewing, lightly guide the prefolded edge (see fig. 29). If too much fabric enters the hemmer, the seam will become bulgy and uneven; if too little, the hem will not be folded in sufficiently and does not close the seam in the correct way.

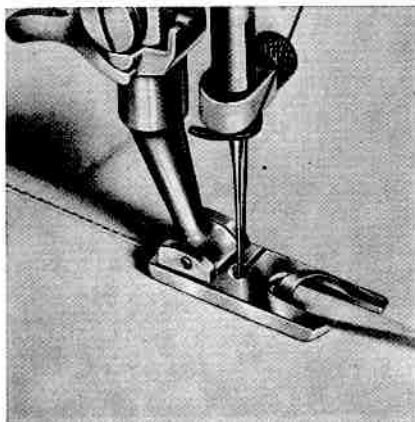

## Gathering foot

(Only supplied against extra charge)

Fig. 30

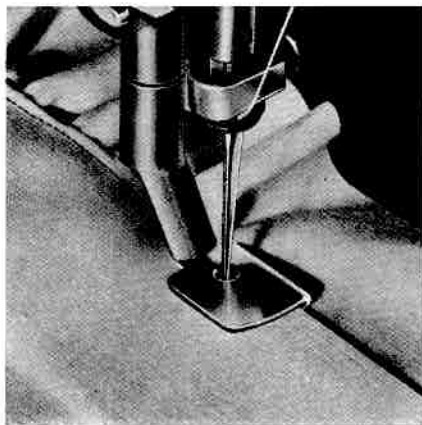

Insert gathering foot. Adjust machine upon plain stitch sewing.

Put the material to be gathered under the gathering foot, that is to say not into the transverse slot. Lower the gathering foot by means of the presser foot lever and insert the piece of material, which must remain quite flat, into the transverse slot of the gathering foot as far as it will go. To increase the amount of gathering on the bottom material, hold the top material back. The more it is held back, the greater the fullness of gathering, and vice-versa.

If only one layer of material has to be gathered, place the material beneath the gathering foot onto the feed dog, and the length of stitches will regulate the fullness of the gathering. A longer stitch will increase the fullness, whereas a shorter one will decrease it.

## Edger

Adjust machine upon plain stitch sewing and insert edger instead of regular presser foot.

The edger with its stitch hole placed farthest to the right of foot is specially suited for edge stitching. For this purpose the edge stitcher is used without the quilting guide.

The edger with the quilting guide is generally used for quilting works (see fig. 31), the distance of the guide from the needle determining the width between the rows of stitches. Adjust adequately and when sewing guide the material in such a way that the quilting guide runs always within the precedent seam. In such a way all the seams – the cross seams included – are quite parallel one against another.

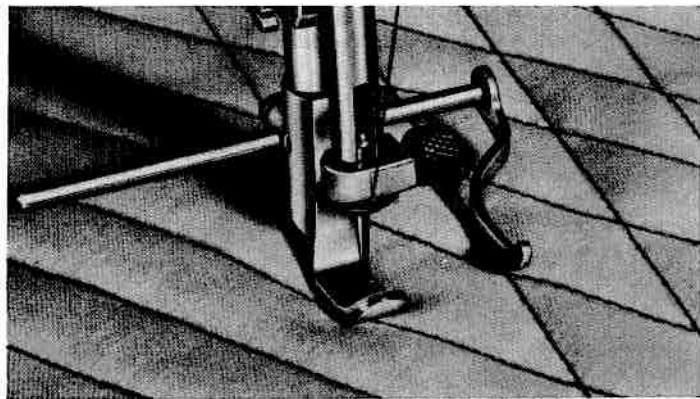
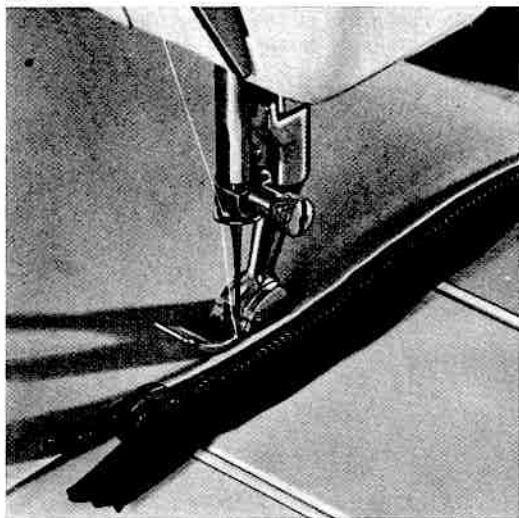

Fig. 31

## THE ZIPPER FOOT

(specially designed for inserting zippers;  
available only against extra charge)

Fig. 32



When inserting zippers be sure that for the stitching of the left side of the zipper the needle position to the right must be used (see fig. 34). Thus knob 17 should be set to the right (see fig. 2).

The stitching of the left side of the zipper must be done with needle position to the left (see fig. 33).



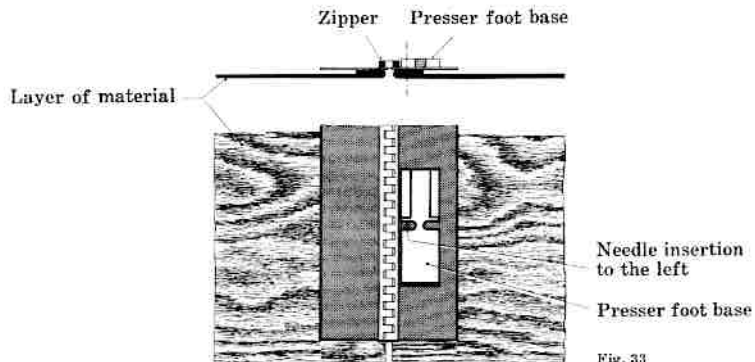

Fig. 33

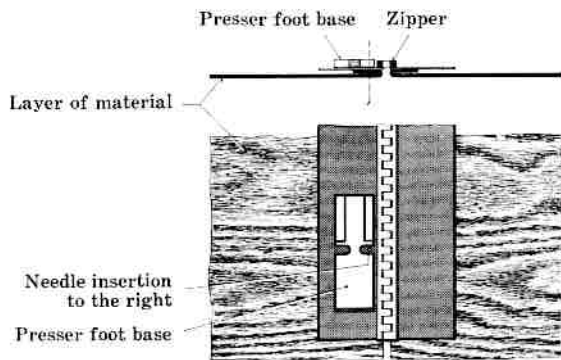

Fig. 34

# Zigzag

## Zigzag Sewing, with service by hand

### Adjustment of Stitch Width

At the right-hand top of the body of the machine the adjustment knob 18 (see fig. 2) which serves to regulate the stitch width will be found. When turning this zigzag adjustment knob 18 the width of the stitches will be set. The pointer on the knob 18 enables you to read on the stitch width scale the actual width of the seam. For plain stitches the

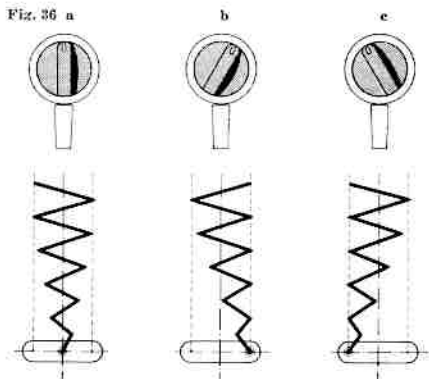

pointer of the knob must indicate number zero on the scale. Thus a plain stitch will result. When turning the adjustment knob 18 to the right (in clockwise direction), the pointer will move from number zero to number four. The higher the number, the wider the stitches. The adjustment knob 18 can be regulated whilst sewing, but when you are not operating the machine, it can be set only when the needle is raised *above the layer of material*.

### Centre - right - left position

Above the zigzag adjusting knob 18 a lever 17 is provided. This lever can also be adjusted when sewing, but when the machine is at a standstill, it can be set only when the needle is raised above the layer of material.

By placing said grip upwards, i.e. when the pointer is in an upright position, the needle throw will be uniform to both sides, proceeding from the centre, to the left and to the right (see fig. 36 a, centre position).

By turning the grip 17 in such a manner that the arrow points to the right, the needle will now throw from right to left when making zigzag stitches, the

- | a) Centre position                            | b) Right position  | c) Left position  |
|---|--|---|
| Needle throw from centre evenly to both sides | Needle throw starting from a straight line at right edge of seam | Needle throw starting from a straight line at left edge of seam |

piercing of the needle being in a straight line only at the *right* edge of the zigzag stitch (fig. 36 b, right position).

On the other hand, if the arrow points to the left, the piercing of the needle will be in a straight line only at the *left* edge of the zigzag stitch (fig. 36 c, left position).

Most zigzag sewing is done with the zigzag stitch adjusted in centre position, while the sewing machine is generally set to the left position when making buttonholes, sewing on buttons, and producing ornamental stitches. For the production of further ornamental stitches the right zigzag position is used, sometimes also by means of combining with the previously mentioned two stitch positions.

### Zigzag Sewing

(Use 2- or 3-ply threads, never 6-ply)

For zigzag sewing set the machine as follows:

1. Raise thread take-up lever 7 to its uppermost position.
2. Insert zigzag foot (not to be mistaken for the zigzag embroidery foot, this latter having its lower surface hollow ground). When raised, leave zigzag foot in this position.
3. Thread upper and under thread, and place both under and to the back of zigzag foot.
4. Turn knob 23 to the right, the symbol  being set on sewing.
5. Adjust stitch regulator 22 onto two wished for stitch length.

6. Fix slide-on table.

7. Lower zigzag foot.

Proceeding from stitch length zero to four, and with a stitch width equally from zero to four, the simple zigzag seams will appear with central needle deflection as hereunder. Of course all intermediate sizes can be used as well as regards the stitch width, as also their length.

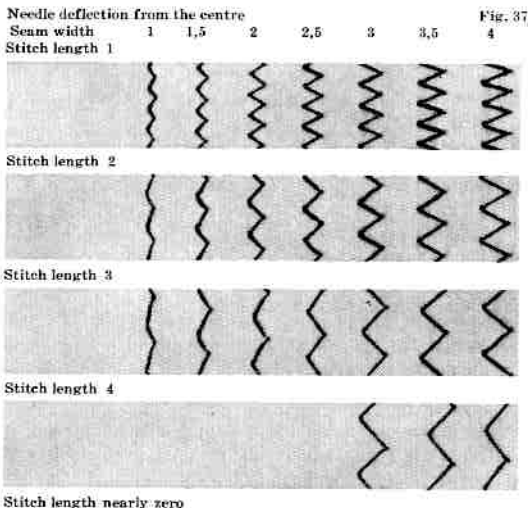

## Elastic Sewing of Knitted Goods

- Always use darning thread for basting tricot and other knit goods. Never do it with basting thread.
- Use perfectly straight and pointed needles. Size 70 to 80.
- The thinnest area of material must be placed under and to the left of presser foot.

If the seam is not even, test whether:

- a) the needle is accurately set;
- b) size of thread does really correspond with size of needle or not.

If the zigzag seam seems to be not elastic enough, it will only be necessary to adjust a larger width and a shorter stitch length in order to obtain a larger elasticity of the seam.

### Mending tricot and other knit goods by means of elastic seams

A fresh piece of tricot fabric is placed on top of the damaged area and basted by hand, using darning thread to this intent.

Fig. 38

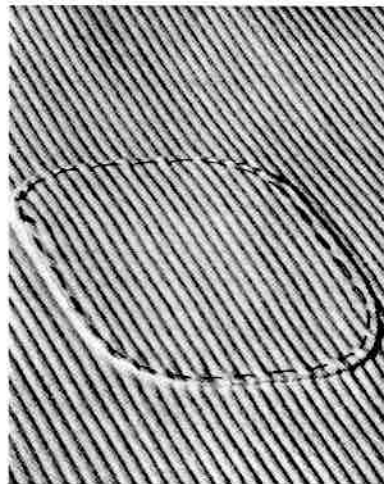

Stitch a zigzag seam along edge and about the depth of presser foot.

Adjustment of machine:

Zigzag width upon 3 or 4

Stitch length upon 1

Fig. 39

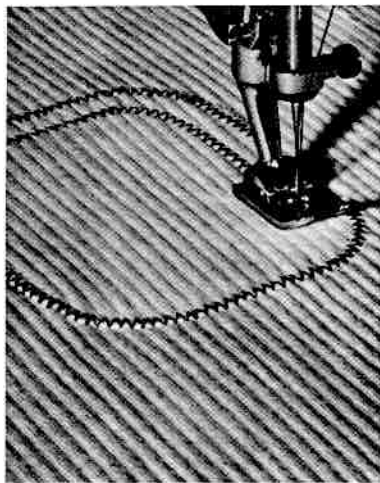

### Tricot seams

With ordinary tricot it is advisable to make a fold with all seams and then stitch across.

Zigzag width upon 2.5-3

Stitch length upon 1.5

Fig. 40

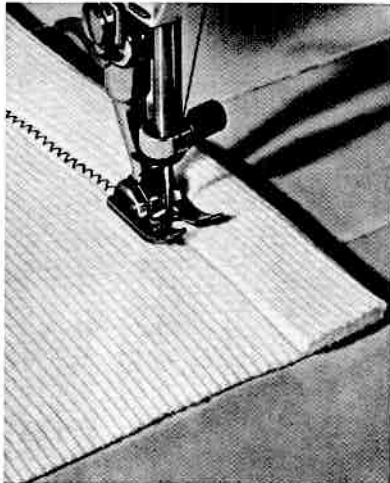

If a seam is stitched without being folded along the edge, it is recommended to stitch first a straight seam with plain stitches approximately  $\frac{5}{64}$ " inside the edge, in place of basting, whereby the material and the seam are prevented at the same time from being distorted.

Zigzag width upon zero mark.  
Stitch length upon 3.

Fig. 41

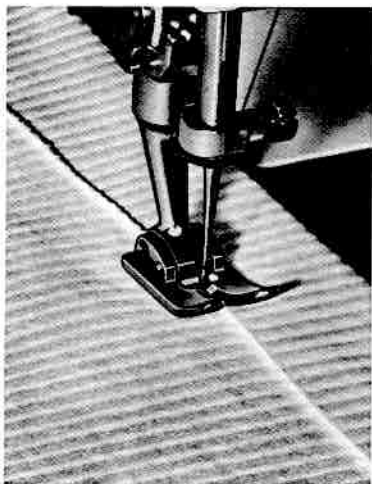

Finish with a zigzag seam.

Zigzag width upon 3 to 4.  
Stitch length upon 1.5.

Fig. 42

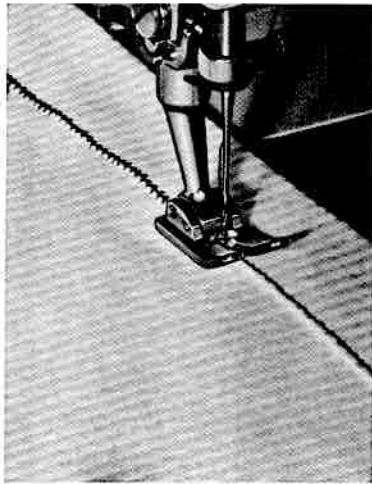

## The tricot or elastic side seam

Fig. 43

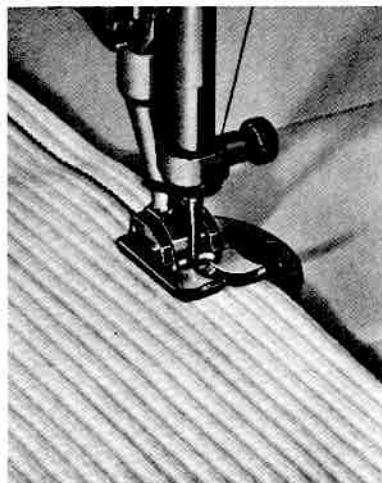

Place both pieces of material on top of one another and stitch a first seam along the edge, the depth of a presser foot.

Zigzag width      1.5  
Stitch length      1

Fig. 44

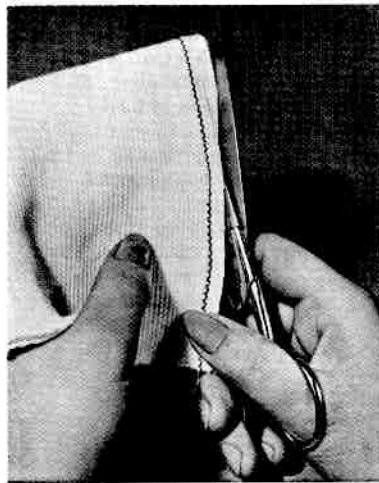

Cut off projecting edge at about  $\frac{1}{8}$ " distance from seam.

Fig. 45



Now stitch another seam across the new edge of material, the double edge being covered with zigzag stitches.

Zigzag width from    3 to 4  
Stitch length from    1.5 to 2

## Sewing on lace

To sew on laces use short stitch lengths and narrow stitch widths as a rule. Normally the stitch length regulator level 22 (see fig. 2) is set at  $\frac{1}{2}$  and the zigzag knob 18 at from 1 to 2. Place lace on material to be sewn, approximately  $\frac{5}{64}$ " to  $\frac{1}{8}$ " inside edge, in order to facilitate sewing on. Now attach the lace with zigzag stitches and then cut off the material edge projecting, along the zigzag seam.

Fig. 46 a

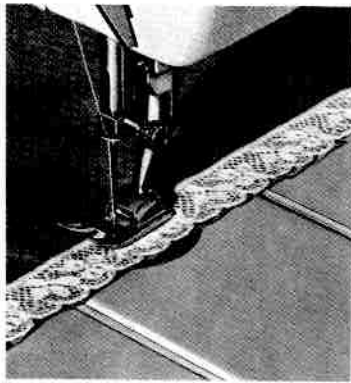
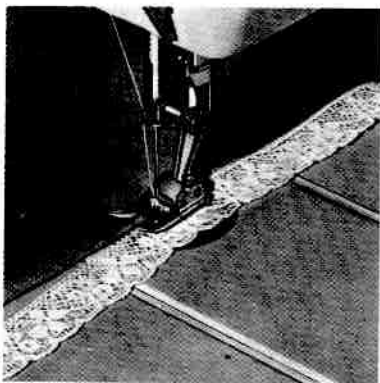

Fig. 46 b



## Roll Hemmer

The roll hemmer, characterized by two red lines on its shank, is similar in shape to the ordinary hemmer. The only difference is that its stitch hole is not round, but rather elongated, so that zigzag seams can be sewn with it. The roll hemmer is operated in the same manner as the ordinary hemmer. The zigzag knob 18 (see fig. 18) is set at approximately 3 or 4. – Roll hems are used particularly for edging fine material.

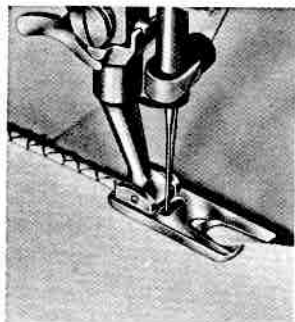

Fig. 47

## The Scalloped Hem

For scalloped hems use the roll hemmer too. The material or elastic fabric is inserted in the spiral guide as for roll hemming. The zigzag stitch bridges the entire seam. Tight top thread tension and large stitch length produce the scalloped effect. This scalloped hem is used mainly for edging knit goods.



## Braiding

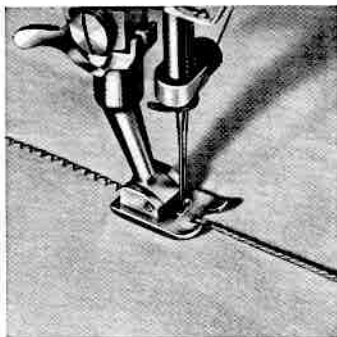

Fig. 48

Introduce a soft cord in the guide hole of the zigzag embroidering foot, which is marked by one red line on its shank, and stitch or embroider over with zigzag stitches.

Use mercerised thread no. 50/2 or 60/2.

A great variety of effects can be obtained with this type of stitch. – Colour thread, coloured cord, or a number of adjacent seams a.s.o. will still enhance the effect.

## Ruffler

Light, soft material such as Batiste, Georgette, Charmeuse a.s.o. may be very attractively ruffled or shirred, using the embroidering foot and working with stitch length 4.

When ruffling rather stiff material such as Poplin, Repps, or Wool a. s. o., a pearl yarn no. 8 is introduced into the guide hole of the embroidery foot and stitched onto the underside of the fabric, sewing a zigzag stitch of 1.5, with a stitch length of 1.5 to 2.

At a distance of  $\frac{5}{64}$ " a second row is sewn with both sides of the crochet (or pearl) yarn shoved together to a uniform ruffle. – If the ruffled part is combined with a straight one, this seam should be sewn in between the two ruffled rows.

Fig. 49

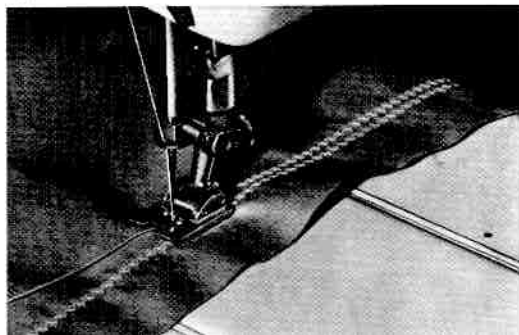

## AUTOMATIC BUTTONHOLE SEWING

*There are three different kinds of buttonholes:*

- a) The ordinary buttonhole.
- b) The buttonhole with cord inlay.
- c) The raised buttonhole.

### The ordinary buttonhole

This is sewn with normal under thread tension, but with a special threading of the bobbin case. The sewing of the buttonhole is effected without turning the cloth around. This can be made either step by step, the machine being stopped after each operation, or in one working operation, i. e. without interrupting the various working stages. It will, however, be well to learn sewing buttonholes step by step; after a little time you will naturally be able to sew the whole buttonhole in one single working operation as well.

Fig. 50

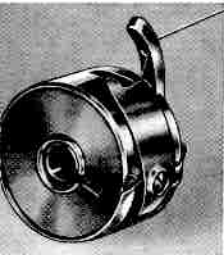

The threading of the under thread:  
An increased tension of the under thread produces still better results when sewing buttonholes automatically. To get this higher bottom thread tension without changing the lower tension itself, which is correct for normal sewing, see fig. 50, a hole has been drilled through the finger of the bobbin case through which the under thread has to be

Fig. 51



threaded. For normal sewing the bobbin case is threaded as explained in this instruction booklet on page 12.

**For sewing buttonholes, the machine should be adjusted as follows :**

1. Insert buttonhole presser foot.
2. Feed-change knob 23 (fig. 2) must stand at symbol "sewing".
3. Draw zigzag knob grip lever 18 downwards, so that it can work together with the fixed stops on sewing machine stand.

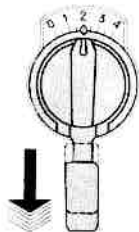

Fig. 52

4. To engage the buttonhole device proceed as follows : Draw the upper lever 19 which is marked with a buttonhole symbol with a light movement towards you and then upwards. Now let it go. The button-

hole device is now engaged in its working position. To disengage the buttonhole device proceed in the reverse order.

5. The stitch length shifting lever 22 is pushed upwards as far as possible.
  6. After the stop has been brought into working position by moving the grip lever of the zigzag knob 18, get hold of it and swivel it in such a way that the pawl comes to lie against stop pin I.
- This is done by moving said lever slightly to the right. Now the pointer pin of zigzag knob 18 will be opposite the scale number 1.5.

Fig. 54

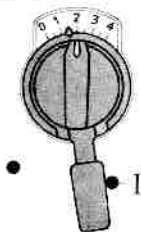

7. Adjust stitch position regulating knob 17 (see fig. 2). The lever is turned so far to the left, until the white mark at the top end is lying exactly opposite the white mark on the zigzag lever 18. Now the machine is perfectly set for buttonhole sewing.

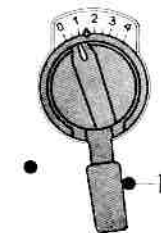

Fig. 55

**The step by step sewing of the buttonhole is now effected as follows :**

*1. Sewing the lefthand edge*

Start the machine; then the lefthand edge is sewn in backward stitch. A scale on the buttonhole presser foot serves for determining the length of the buttonhole. After the wished for length of the edge has been attained, stop the machine.

Always take care that the needle is then up and outward of the work itself.

*2. Sewing the first end stitches*

For this purpose take hold of the zigzag lever 18 and give it a strong push to the left, until it hurts stop

II. Then sew a few end stitches, and after that stop the machine again and set the needle up (fig. 57).

*3. Sewing the righthand edge*

Bring the zigzag lever 18 back from lefthand stop I to righthand stop I and start the machine again. Stop it again a few stitches before the righthand edge has become as long as the lefthand one and set the needle again up (see fig. 58).

*4. Sewing the second end stitches*

Again set the zigzag lever 18 to the stop II. After a few stitches have been sewn, stop the machine once more and set the needle up as before (fig. 59).

Fig. 56

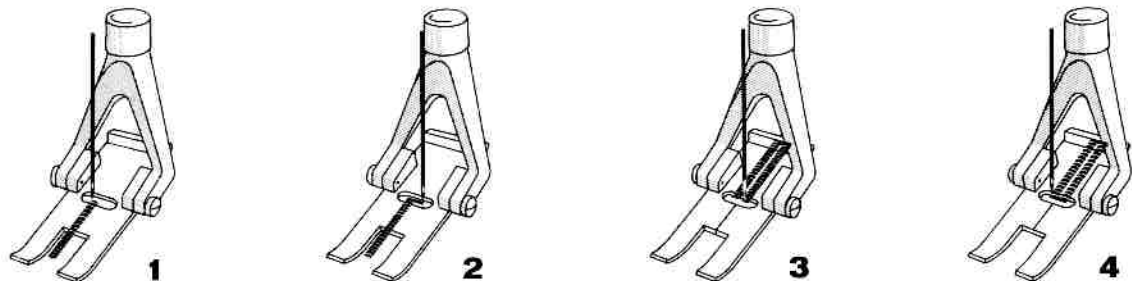

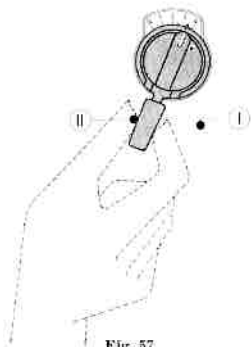

Fig. 57

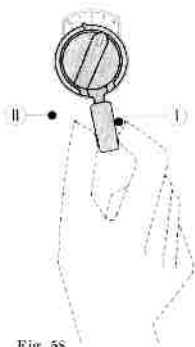

Fig. 58

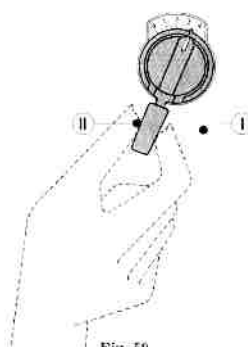

Fig. 59

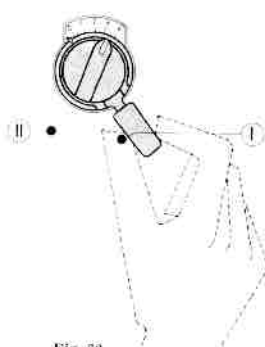

Fig. 60

### 5. Sewing the fastening threads

For stitching the fastening threads, pull the zigzag lever 18 – which is still against stop II – towards the front and push it entirely to the right, passing thereby over stop I (see fig. 60). In this position the machine now sews the plain stitch, in order to make fastening threads. When stitching these securing fastening threads, it will be advisable to hold the fabric slightly back.

For the next buttonhole zigzag lever 18 and the other levers should be adjusted as follows:

1. Set zigzag lever 18 again against stop I.
2. Turn lever 17 to the left, until the white lines of the levers 17 and 18 are facing each other.

3. Push the stitch length regulating lever 22 upwards as far as possible, until it hurts the stop. Now the machine is again correctly adjusted for buttonhole sewing and the handling of zigzag lever 18 is again effected as stated under “the step by step sewing of the buttonhole”.

### Sewing the buttonhole in one single operation

In contrast to the described method, the buttonhole can easily be sewn in one operation, i.e. without stopping the machine after the different working steps. The buttonhole is sewn in one operation as follows: After having adjusted the machine for buttonhole sewing and having pressed zigzag lever 18 against stop I (see fig. 54), set the machine going and keep

on holding zigzag lever 18. As soon as the wished for length is reached, move the zigzag lever 18 with a firm movement against stop II (fig. 57), and because only a few stitches are necessary for sewing the fastening ends, move the zigzag lever 18 corresponding to the sewing speed so to say immediately again to stop I and press it against said stop.

As soon as the second, righthand bead has reached the length of the first lefthand one, except for a few stitches, move the zigzag lever again to stop II, and since also here only a few stitches are required for the second fastening, move the zigzag lever immediately quite to the right, in accordance with the sewing speed, i.e. beyond stop I by drawing the zigzag lever 18 towards you, i.e. to the front (fig. 59 and 60).

### Regulating the distance of stitches

The BERNINA-Record, Model 730, is provided with a patented device by means of which the distance between stitches can be altered when sewing buttonholes or working the satin stitch, according to the material being stitched and the sewing thread. The change is operated with the stitch regulator knob 21 fitted with a numbered scale from one to five. According to the kind of fabric to be stitched, finer, medium, or stronger ones, or even tricot, the feed of the fabric will differ when sewing buttonhole bars.

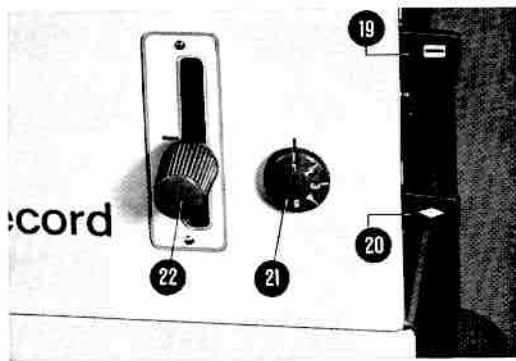

Fig 61

With stronger and softer material the feed should be increased. This change takes place by turning regulator knob 21. This regulation knob is fitted with numbers equivalent to those of the fixed scale on the machine itself (machine stand). If number 1 is placed opposite the fixed scale, it means that the smallest feed has been chosen for the buttonhole bar. Turning the knob to the left, the number will be a higher one and the feed is increased. That means that now for every kind of fabric the corresponding distance between stitches may be chosen at will. The same adjustment for making the bars of the buttonhole is valid too for ornamental stitching with the same fabric.

### Buttonholes with cord inlay

As inlay use thin cotton cord and place it, as is shown in fig. 63, on the nose at the back end of the buttonhole foot, and sew the buttonhole in the described manner.

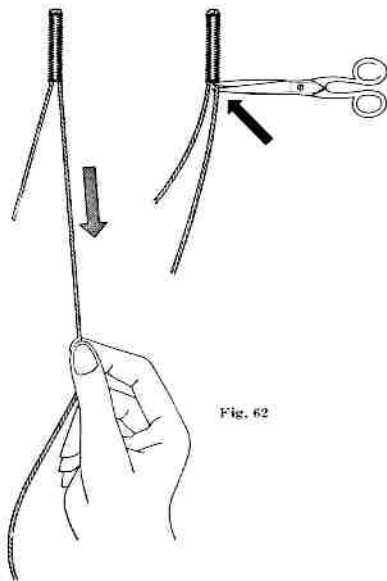

Fig. 62

The cord loop projecting beyond the back end of the finished buttonhole is tightened in such a way that the loop under the back fastening disappears. Then the two thread ends are cut (see fig. 62).

### The raised buttonhole

The buttonhole is sewn with a slack lower tension and a strong upper thread tension. The upper thread tension has to be so strong that the bottom thread appears in a straight line on the upper side of the material. For raised buttonholes the top thread must be unglazed, 6-ply no. 40 thread, whereas a very thin thread is required for the bobbin (f.i. 60/2).

Fig. 63

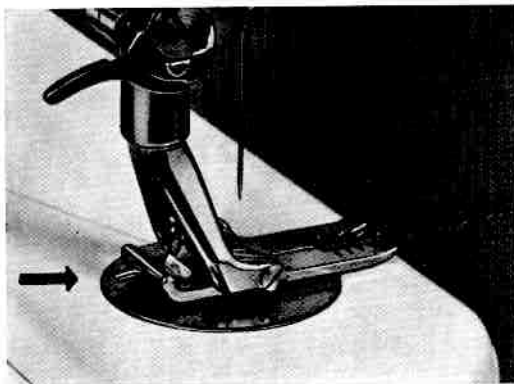

## Adjusting the machine from automatic buttonhole sewing to zigzag or straight plain stitch

The grip lever of the pointer knob 18 (see fig. 51) is pushed upwards. Now the lever of zigzag knob 18 can be swiveled at will from zero to four over the stops I and II. Lever 17 is swiveled into upright position, making the needle pierce into centre of stitch hole with zero stitch. Grip lever 19 with buttonhole symbol is drawn to the front and pushed into its lowest position.

Never put the machine away before having changed over from buttonhole adjustment to zigzag and straight plain sewing, in order to have the machine ready for sewing these works when using it another day.

## Sewing buttonholes without using the automatic buttonhole device

Buttonholes may also be sewn without using the automatic buttonhole device. In such cases make the following adjustments:

1. Insert buttonhole foot marked with three black lines on its shaft.
2. The lever 18 (see fig. 2 and 51) remains in its position as with zigzag sewing.
3. The needle displacement lever is set to its left position by turning lever 17 completely to the left

(see fig. 36). In doing so don't use the white marking.

4. Set zigzag knob pointer 18 on 1.5 to 1.7. When sewing a buttonhole in knit material, select stitch width 2.
5. Set stitch-length lever 22 so that it comes to lie somewhat below the zero mark on the stitch length scale plate. This can only be done if the grip of the stitch-length lever is not fully turned in.
6. Set drop feed reversing knob 23 (see fig. 2) on "sewing" symbol, by turning it to the left.
7. Now sew the first edge to the length of the wished for buttonhole. The last needle stitch of the finished edge must be on the right, whereby the needle remains inserted only  $\frac{3}{64}$  to  $\frac{1}{8}$ " in the material.
8. Raise buttonhole presser foot and turn cloth  $180^\circ$  in clockwise direction. Then lower presser foot and allow the needle to enter the material towards the left. Again needle should penetrate into the material only with its point.

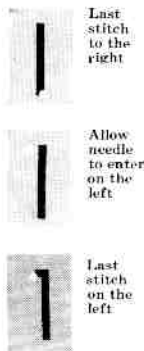



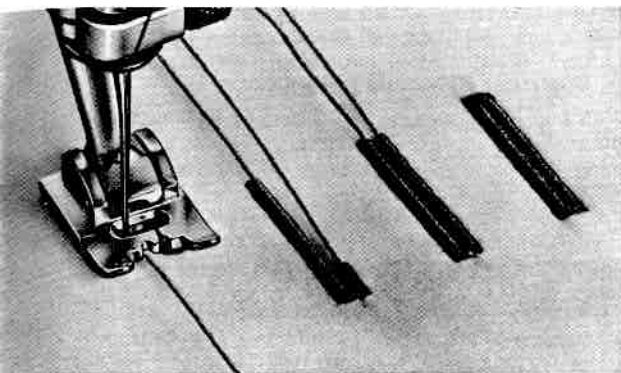

Fig. 64

9. Set zigzag lever 18 to 3.5 and sew a few end stitches for the bar. In doing so, pull material lightly towards you to shorten the feed. Last needle hole should be to the left. Allow needle to penetrate material only with its point.
10. Set zigzag knob 18 once more to no. 1.5-1.7 and sew the second edge over a somewhat shorter length than the first one. Last needle hole to the left.



Last  
stitch  
on the  
left



Last  
stitch  
on the  
left

11. Set zigzag knob 18 again at twice the bead width and sew the end stitches for the buttonhole bar. Again pull material somewhat back to shorten the feed. Last needle hole on the left.
12. Set zigzag knob 18 at zero position and sew a few fastening stitches, again pulling the material lightly towards you to shorten the feed.
13. Finally lay the work on the wooden support and cut the cloth between both edges (see fig. 65).

Fig. 65

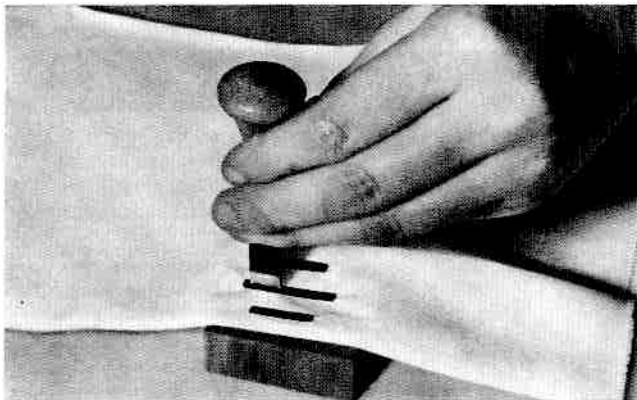

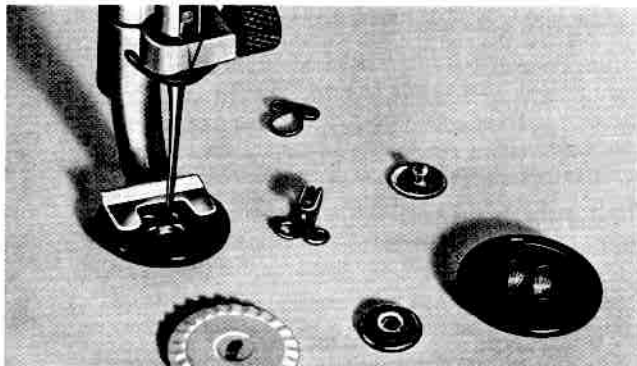

Fig. 66

## Sewing on Buttons

1. Position needle to stitch in on the left. Adjust lever 17 also to the left.
2. Lower feed dog by turning reversible knob 23 (see fig. 2) to the right until darning symbol appears.
3. Attach button presser foot marked by two black lines on its shank and place button under foot according to fig. 66.
4. Adjust zigzag stitch width according to the distance between the stitch holes in the button and sew on button with six or eight stitches.

5. To fasten stitches the needle must always stitch in a hole of the button. The zigzag knob 18 (see fig. 2) is adjusted on zero position and fastening takes place means of a few stitches.

With four-hole buttons shift the cloth with the button and make six or eight stitches in the second pair of holes. Press-studs and hooks are sewn in like manner too.

## Darning with wool

When darning with wool, use the patented wool-darning foot. Proceed as follows :

1. Lower feed dog in turning the reversible knob 23 (see fig. 2) to the left until darning symbol appears.
2. Set stitch length regulator lever (see fig. 2) to zero, to prevent lowered feed dog from being operated unnecessarily.
3. Set zigzag knob 18 (see fig. 2) on 3 to 4.

For top and bottom thread use darning cotton. Wool is employed to cover the damaged area. Top and bottom threads, and darning wool of a colour corresponding to the piece to be mended, will be chosen so that the darn should be as invisible as possible. Thread is the same as in ordinary fastening.

Woollen socks are pulled over the free arm without using the darning ring for stockings.

Darning with wool is performed in two stages, i.e.:

1. The damaged area is covered with wool.
2. The covering wool rows are sewn down.

As appears clearly from fig. 67 a, the wool is introduced in the slot of the presser foot, whereby the thread is allowed to project over the rear edge of the presser foot by approximately  $\frac{25}{64}$ ". Now span the hole with wool as shown in fig. 67 b. Start at the left hand top corner of the damaged area and stretch

wool sideways, i.e. from left to right and vice-versa, by shifting the fabric accordingly to and fro. At the end of each run the zigzag stitch will tack the wool to the fabric, when direction of movement is changed. Make sure that these runs are as close as possible together, because later on no more wool will be used.

As soon as the damaged area is entirely covered with wool, the wool thread is cut at the darning foot. Now fasten the wool rows with zigzag stitches across them as is shown in fig. 67 c, by shifting the fabric forward and backward. Zigzag stitch is employed to ensure that the mend remains fully elastic and care should be taken not to place the individual zigzag runs too closely together.

Fig. 67

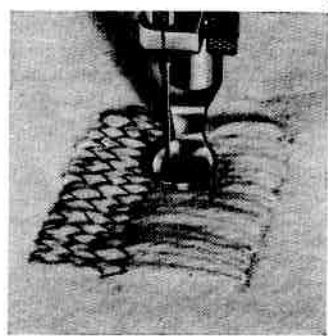
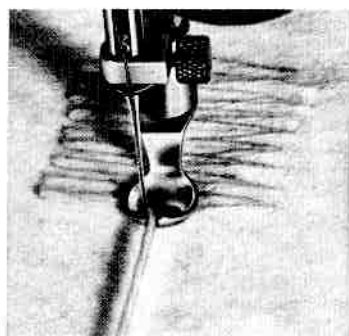
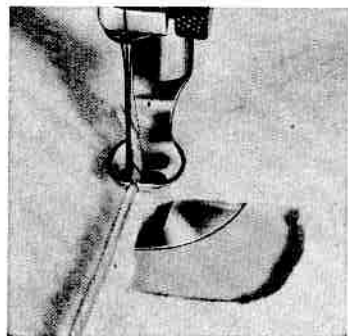

## Applique Work

(Needle stitch to the left)

An attractive decorative effect is obtained by sewing cut-outs of materials of different colours or tulle to the cloth. Application work is mainly employed on collars, ladies' and children's dresses, linen, and the like.

The buttonhole presser foot is advantageously used for this type of sewing work.

First draw the shapes to the underside of the cloth. The fabric from which the designs are cut should be of a pleasant contrasting colour. Cut piece slightly larger than required and baste same on the right side of the material, thus not on the side of the design. Then sew a narrow zigzag stitch row with no.  $\frac{1}{2}$  to 1 – not too short – along the lines of the design. The sewing thread should be of the same colour as the fabric applied. Then remove basting and trim cautiously along the sewing line on right side.

Now finish the application work by sewing a wider ( $2\frac{1}{2}$ ), short zigzag line over the edges of the cut-out on right side of material.

Fig. 68

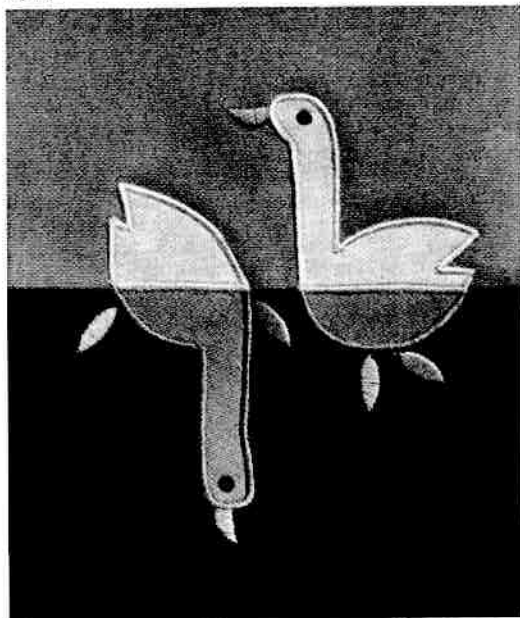

## Ornamental stitches, hand-operated

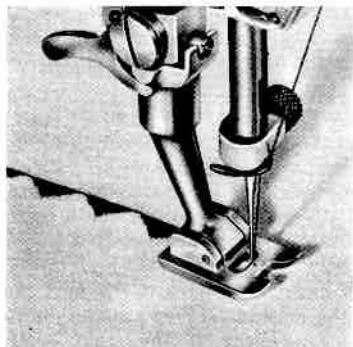

Fig. 70 a

Zigzag embroidering foot (1 red line)  
Ordinary zigzag sewing foot

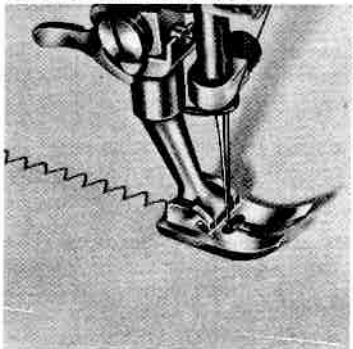

Fig. 70 b

### The zigzag ornamental stitch

With the BERNINA zigzag sewing machine device on the Models no. 730 and 732 the most various ornamental stitches can be produced in the simplest possible manner.

According to the ornamental stitch desired, the stitch regulation lever 22 is more or less depressed and the zigzag knob 18 turned in both directions, to and fro, during sewing. After a few experimental stitches the sewing of ornamental stitches becomes indeed very easy.

For ornamental stitches of normal stitch length use the zigzag sewing foot (see fig. 70 a). However, for stitches of very short length the zigzag embroidery foot (see fig. 70 b) should be employed. This latter has a recessed lower face.

## SATIN STITCH CONTROL

The adjustment of the right stitch length for ornamental stitches and buttonholes is very easy on the BERNINA sewing machine thanks to the patented satin stitch control.

Suppose the stitch length regulating lever is on no. 2 and the stitch length must be adjusted for sewing a buttonhole.

First the satin stitch control lever 20 is swiveled as far as possible upwards and afterwards the stitch length regulating lever 22 is equally pushed upwards until it stops.

The satin stitch control must only be brought into the disengaged position if the machine serves also for backward sewing. This disengagement of the satin stitch control takes place by pressing the lever 20 down, whereby the normal state for the selection of the stitch length, forward and backward, is again restored.

As following the thickness of the yarn which has to be used for the different works the stitch length must be smaller or larger, the satin stitch control is laid on an eccentric axis. By turning knob 21 a bit to the left, the stitch length will be prolonged following the numbers indicated on said knob. You will find there the numbers from 1 to 5.

The thicker the yarn to be used and the stronger the cloth to be worked, the more the knob must be turned towards the left, in the direction of the next higher number on knob 21. The knob must be adjusted so that seams of uniform thickness can be achieved.

Fig. 71

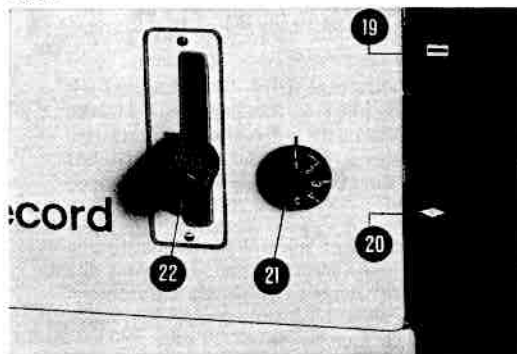

## Automatic Fancy Stitches

Every BERNINA-Record sewing machine of the Model 730 and 731 is equipped with the automatic ornamental stitch device which enables the creation of ornamental stitches to be sewn without manipulating any controls.

Just select the pattern desired, set the control lever, and then simply concentrate on guiding the fabric through the machine with both hands free to do so.

The BERNINA cl. 731 has four automatic fancy stitches only. Its operation is identical to that of cl. 730.

### Reversal upon automatic ornamental stitch sewing

The reversible lever 13 for zigzag or ornamental stitches is placed at right-hand side of the top arm (see fig. 72). It projects from the slot in the plate 113. If the machine is to be set for control by the automatic ornamental stitch device, push lever 13 backwards; to the contrary, put this lever forwards, if you wish to reset the sewing machine for zigzag stitches.

*The following section is applicable only to Model 730 and 731*

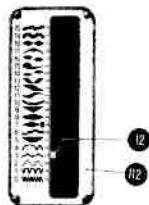

Scale Model 730

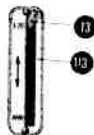

Fig. 72 a ▲

Scale Model 731

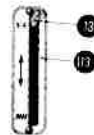
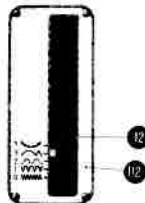

Fig. 72 b ▼

At the left of the zigzag lever is placed the ornamental stitch selecting lever 12 which equally projects from plate 112. This plate bears the symbols of the twenty possible ornamental stitches to be sewn. When sewing zigzag stitches, lever 12 which shows a white line on its side facing the scale images, is set at zero, marked by a zigzag line, i.e. in front position. - If you have selected an ornamental stitch, set switching lever 12 against that symbol so that the white line thereon lines up with its mark.

This is made in the following manner: Pull lever 12 to the right in its guiding slot and displacing it until its line and the stitch symbol line up, and then

Stitch width 4

Stitch length nearly zero

Pattern no.

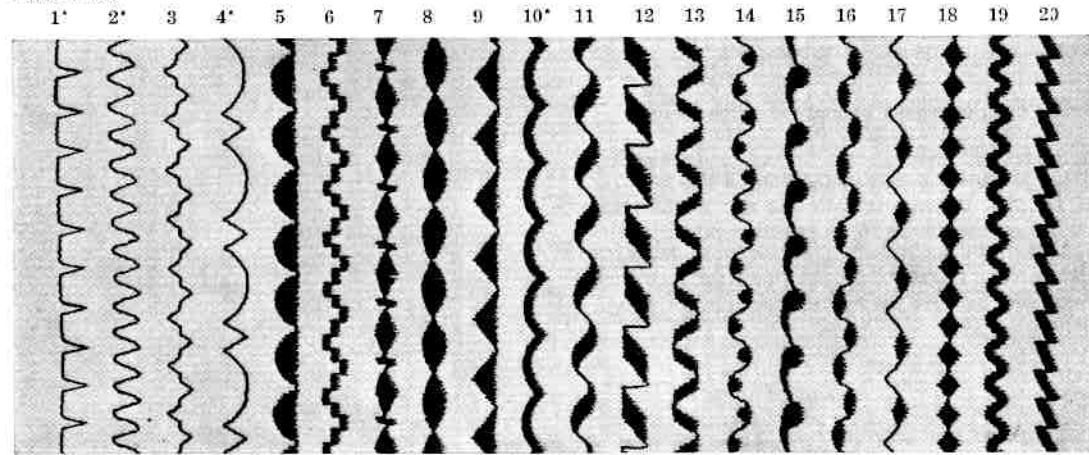

Fig. 73

release. It will automatically be locked at once and remain in this position. When displacing said lever make sure that the needle is outside the fabric, i.e. in its raised position. The stitch width adjusting knob 18 should be set in such a way as to show the number 4 in the sight opening, i.e. to produce the largest stitch width.

After threading the machine, ornamental stitching can be started exactly in the same way as with ordinary sewing.

When switching back to normal zigzag stitches, place switching lever 13 again in front position.

The fancy stitches of cl. 731 are marked with an asterisk (\*).



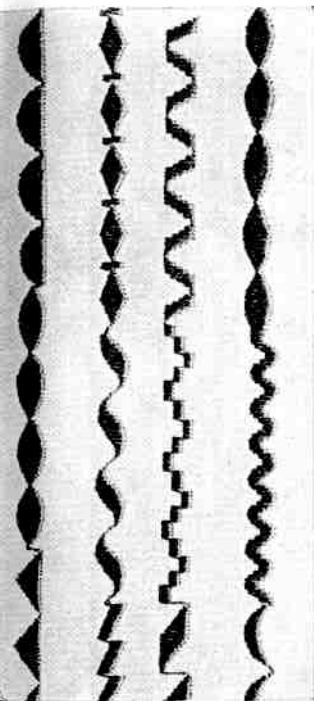

Stitch length  $\frac{1}{2}$   
Stitch width 4

Fig. 74

### Automatic ornamental stitches with one single needle

The stitch patterns can be carried by changing the stitch length from almost zero to four.

A further variation is feasible by combining individual ornamental stitches during the sewing itself as seen from the examples on side of this page.

- Patterns combined with each other (see fig. 74).
- Different seam patterns combined together (see fig. 75).

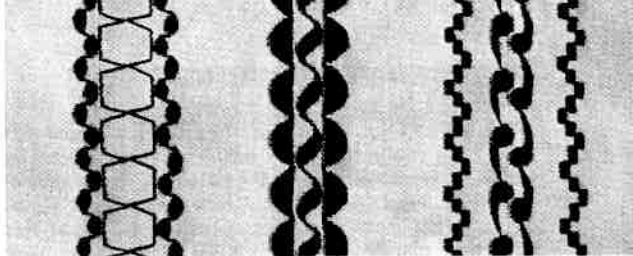

Fig. 75

### Ornamental automatic stitches with two needles (see fig. 76)

Zigzag stitches are equally possible when sewing with two needles. However, make sure on principle that the two needles are not displaced further than allowed by the elongated hole in the stitch plate.

Needle throw plus distance between needles equals width of elongated hole. When a double needle with  $\frac{3}{64}$ " needle distance is used, the stitch width may not exceed  $\frac{3}{64}$ " as a maximum.

Naturally ornamental stitches made with two needles may also be modified by altering the material feed and by thread selection of two colours.

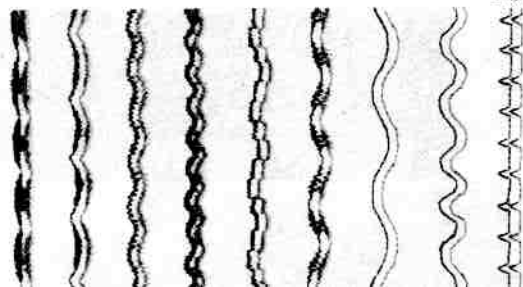

Fig. 76

## THE ORNAMENT INDICATOR

The BERNINA-Record of the Model 730 and 731 has been equipped with a novelty, the ornament indicator, showing the actual position of the ornament being stitched. At the front side of the arm, to the right, near the tension sight hole, another sight hole has been managed, which is filled with a mark. Now, when the machine is sewing an ornament, the ornamental stitch symbol is moving inside the machine and passes this sight hole, where it can be seen (see fig. 77).

Even when operating the machine at great speed, this symbol can be clearly observed when it passes

Fig. 77

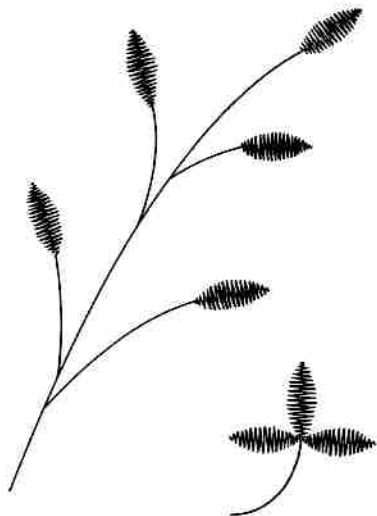
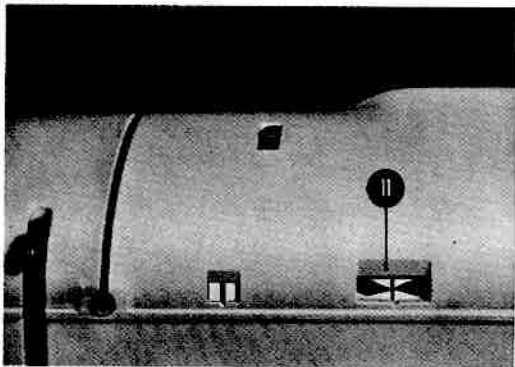

through. As soon as the front end of the ornamental stitch is cutting the mark, the machine begins to stitch a new ornament. When one half of the ornament has passed the marked sight hole, this means that half of the ornament has been stitched. With this marked sight hole it is now possible to notice the moment when the machine is beginning to sew said ornament. This device will be of great importance when sewing ornaments of which only one single ornament has to be stitched and placed within a certain area. It will also be of value when changing an ornament altogether.

Fig. 78

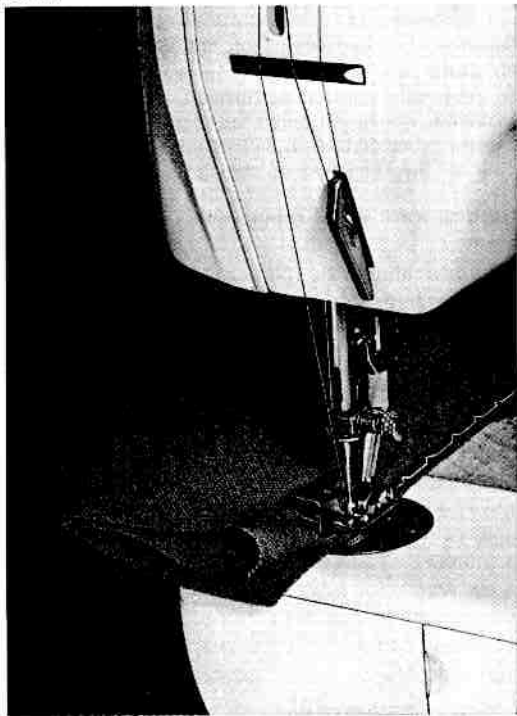

## Blindstitch sewing

Blindstitch sewing means sewing together two pieces of cloth, the upper one being folded and sewn to the lower one in such a manner that the seams are invisible on one side.

Such work is performed with the blindstitch foot (see fig. 78) which possesses an elastic cloth guide between the fingers on its base, but otherwise is identical with an ordinary presser foot.

Blindstitch sewing can be accomplished with the ordinary zigzag stitch or by means of the built-in blindstitch cam.

1. **Setting of machine when sewing with ordinary zigzag stitch**
  - a) Attach blindstitch foot.
  - b) Deflect needle to right position.
  - c) Set zigzag knob to a stitch width between 2 and 3, according to thickness of material.
  - d) Set stitch length regulating lever to stitch length 4.
  - e) Set feed dog reversible knob on "sewing" symbol.

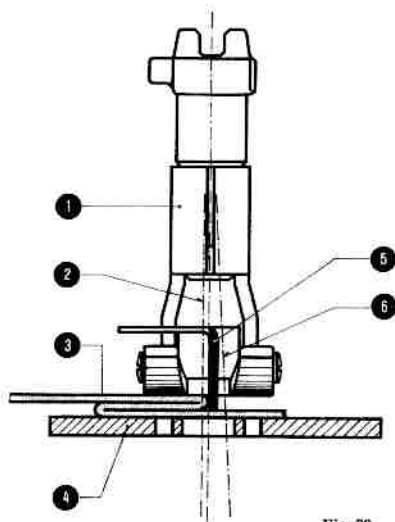

Fig. 79

- ① Blindstitch foot (No. 55 06 82 03)
- ② Left position of needle stitch
- ③ Folded upper piece of material
- ④ Needle plate
- ⑤ Material stop and guide
- ⑥ Right position of needle stitch

After having threaded the machine, put the lower flat piece of cloth underneath the blindstitch foot; then place the upper piece of material on top and fold it in such a way that it always touches the elastic guide; lower the blindstitch foot, and start sewing.

The zigzag stitch width should be adjusted in such a way that in its left deflection the needle is stitching through the middle of the folded piece of material, which will make the seam invisible on the upper piece of material when flattened. Said stitch width is between 2 and 3, depending on the thickness of the cloth used.

## 2. Adjustment of sewing machine for sewing with the blindstitch cam

Whereas, when blindstitching with the normal zigzag stitch, the folded piece of material is pierced after every second stitch, when using the blindstitch cam there are five straight plain stitches between each piercing of the folded piece of material. Thus the machine should be adjusted as follows :

- a) Attach blindstitch foot.
- b) Connect automatic device by means of lever 13 (see fig. 2 and 72) backwards.
- c) Set lever 12 on blindstitch cam (1).
- d) Set needle into right position of stitch.
- e) Set zigzag knob 18 to a stitch width between 2 and 3, depending on thickness of material.
- f) Set stitch length regulation lever 22 on a stitch length of 2, 3 or 4, according to kind of cloth.
- g) Set feed dog reversible knob 23 on "sewing" symbol.

The blindstitching itself is made exactly as has been described under 1.

## Pintucking

Fig. 80

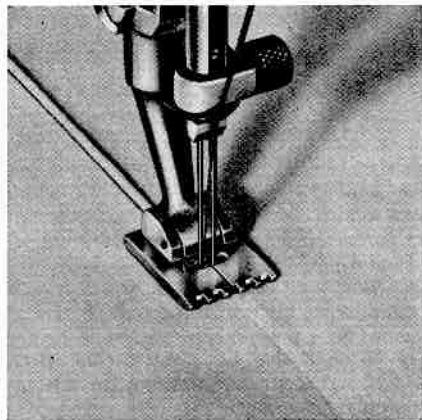

The complete pintucking attachment comprises the following parts:

- 3 double needles for pintucks of approximately  $\frac{5}{64}$ ",  $\frac{1}{8}$ " and  $\frac{5}{32}$ ".
- 3 pintuckers with 3, 5 and 7 grooves.

When preparing the machine for pintucking, proceed as follows:

1. Set needle to centre position in stitch hole by adjusting grip 17 (see fig. 2) in the middle.
2. Set zigzag stitch lever 18 (see fig. 2) upon zero position.
3. Remove standard needle from needle bar and introduce a double needle, proceeding by the way as with a standard needle.
4. Attach the pintucker foot corresponding to the needle distance, i. e.

### Pintucker foot

- with 7 grooves / DUO needle of  $\frac{5}{64}$ " distance
- with 5 grooves / DUO needle of  $\frac{1}{8}$ " distance
- with 3 grooves / DUO needle of  $\frac{5}{32}$ " distance

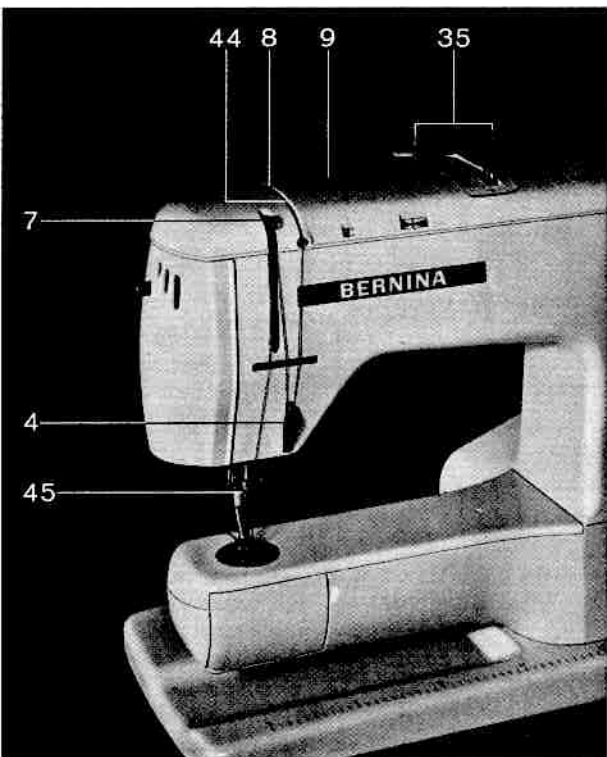

Fig. 81

- |                                   |                         |
|-----------------------------------|-------------------------|
| 4 Thread tension regulator        | 35 Spool pin            |
| 7 Thread take-up lever            | 44 Thread guide slit    |
| 8 Thread tension                  | 45 Needle holder eyelet |
| 9 Thread tension regulation disc. |                         |

#### Threading the two upper threads

To thread the two upper threads of the machine for pinking, proceed as for normal sewing. Place the two reels of thread onto the two pins 35 of the double spool holder at back on top of machine arm. Now pass the thread of the front reel through pretension disc 43, also placed at the back; then into slot running across top arm and draw the thread into left tension disc, down to thread tension regulator 4, and up again through slot of thread take-up lever 7. Then down again to needle holder eyelet 45 and finally from front to rear through eye of left needle. With the second thread proceed in the same manner, but draw it through the right tension disc. From there through thread tension regulator up to thread take-up lever and into the slit of same. Now down again to needle holder eyelet and finally through eye of right needle. Both threads should always run separately through thread tension in order to produce finer pintucks.

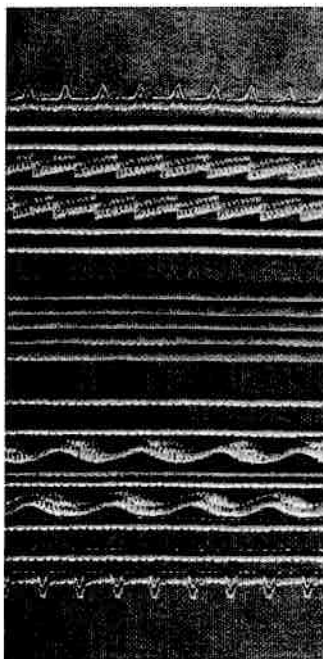

Fig. 82

### The pintucking

A pintuck is formed by the bottom thread which pulls the two top threads together, so that the fabric between the needles is raised and forms a tuck.

For pintucks with inserted cord the insert is passed from the ball slipped on a thread reel pin of the container through the groove in the flap, up through the hole in the stitch plate between both teeth rows of the feed dog, and guided away from operator below and to the back of the pintucking foot.

### Ornamental stitch with double needle

When employing one pintucking needle and the standard zigzag presser foot, a parallel double ornamental stitch can be produced, whereby choose preferably the two threads of different colours.

When using a double needle with  $\frac{5}{32}$ " or  $\frac{1}{8}$ " needle distance, an additional small zigzag motion can be performed. The needle deflection should, however, only be so large that neither needle fouls the hole on the stitch plate either on the left or on the right.

Therefore the zigzag knob 18 (see fig. 2) should only very slightly move to the left, starting from zero point.

## Hemstitch sewing



Hemstitches can be made:

1. with the single hemstitch needle, using the BERNINA zigzag sewing machine, Models 730, 731 and 732;



2. with the patented double needle, using the BERNINA zigzag sewing machines.

With the *single hemstitch needle* only effects resembling hemstitch can be obtained, particularly on thin fabrics such as organzine, organdie a.s.o., whereas with the patented *double hemstitch needle* genuine hemstitches can be made, which are known as *one-needle hemstitch and double-needle hemstitch*. In this manner it is possible to work not only thin, but also medium-thick and thick kinds of cloth altogether. In the following description the several operations will be represented, together with instructions as to the choice of threads to be used and the adjustment of the sewing machine.

### 1. Hemstitch sewing with the single hemstitch needle on BERNINA zigzag sewing machines

Introduce the hemstitch needle into the sewing machine instead of the normal sewing needle.

Threading is done in the well known manner (see Operation Instructions on page 14).

As upper thread use darning or fine embroidery thread (f.i. DMC no. 100).

As under thread use equally darning or fine embroidery thread (f.i. DMC no. 100).





Fig. 83

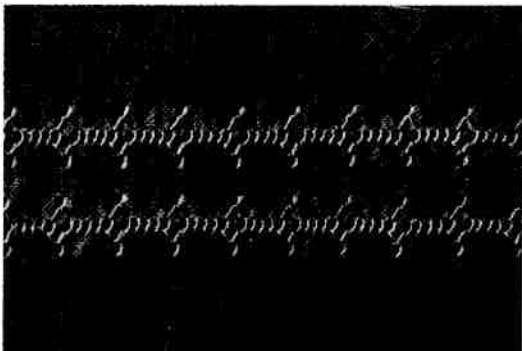

Fig. 84

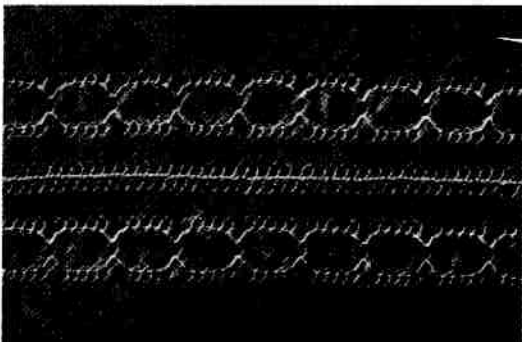

Fig. 85

For fine fabrics, such as organdie, organza a.s.o., set zigzag lever to stitch width 2 and stitch length adjusting lever to 1. After having brought up the under thread, lay the fabric under the presser foot and begin to sew in the well known manner. The result will be a hemstitch as shown in fig. 83.

If suitable ornamental stitches of the automatic system are used instead of the usual zigzag stitch, effective ornamental hemstitches will be produced, such as shown in the following illustrations.

*With ornamental stitch cam no. 1*  
(Blindstitch)

Sew first seam. After having reached the required length, turn the fabric by 180 degrees and sew the second seam in such a way that the zigzag stitches are opposite each other.

Stitch length: 1.5  
Stitch width: 3.5

*With ornamental stitch cam no. 1*

Sew first seam. After having reached the required length, turn the cloth by 180 degrees and sew the second seam in such a way that the needle, when deviated (i.e. every 6th stitch), pierces into the hole already existing from the first needle. In the middle of the illustration, just between the two ornamental stitchings, there will be a normal seam with the ordinary zigzag stitch.

Stitch length: 1.5  
Stitch width: 3 to 3.5

*With ornamental stitch cam no. 2*

Sew first seam. Leave the needle stuck into the fabric at the side where the second seam is wanted. Then turn the fabric by 180 degrees and sew the second seam alongside the first one.

Stitch: length 1.5, width 3.5

The two outer seams are ornamental stitch no. 19

Stitch: length 1, width 3.5.

Fig. 86

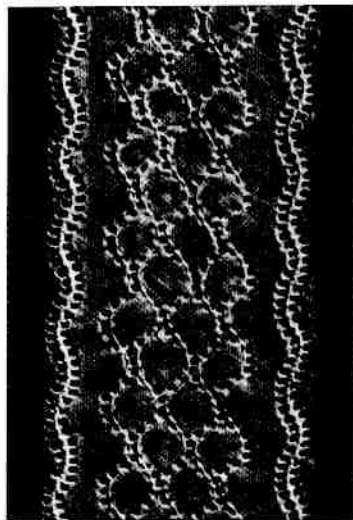

Two seams with normal zigzag stitch

Stitch length: 1

Stitch width: 2

Between both zigzag stitches sew an ordinary ornamental seam with normal sewing needle.

Fig. 87

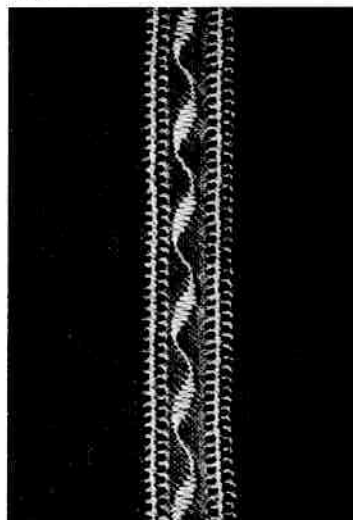

Two seams beside each other; when sewing the second seam take care that it must lie at the left of the first seam and that the needle – when sewing the righthand stitch – pierces into the existing holes of the first seam.

Stitch length: 1

Stitch width: 2

In the middle sew an ornamental stitch no. 19, using a normal sewing needle to this purpose.

Fig. 88

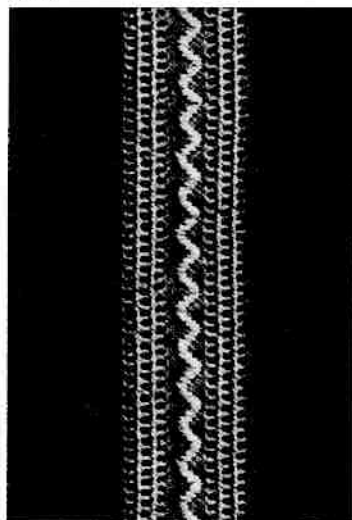

**2. Hemstitch sewing with the patented double needle on BERNINA zigzag and plain stitch sewing machines with transversely set shuttle, zigzag stitch plate and zigzag presser foot**

Insert the double hemstitch needle into the machine instead of the normal sewing needle.

The threading of the upper threads is made in the same way as when sewing pintucks (see Operating Instructions).

As upper thread use f.i. DMC no. 100 with  
lefthand twist

As lower thread use f.i. DMC no. 50 with  
righthand twist

With zigzag machines the zigzag lever should be set at zero point or at plain stitch.

In both cases the stitch length regulation lever should be adjusted at 1 to 1.5.

Direction of cloth feed



After having brought up the under thread, lay the fabric under the presser foot and sew a straight seam as when plain stitching.

This produces a hemstitch (see fig. 89) such as is well known as a *one-needle hemstitch*.

Fig. 89

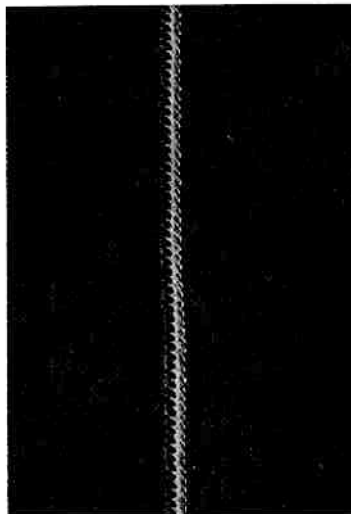

If a hemstitch known as *two-needle hemstitch* must be made, a second working operation will be needed. After having sewn the single hemstitch, turn the fabric by 180 degrees, allowing the point of the

wide needle to touch the fabric which is then turned round that point. Now the second seam can be sewn in the same manner, but take care that the wide needle always enters the previously made hole (see fig. 90).

↓ Direction of cloth feed during first working operation

↑ Direction of cloth feed during second operation



Examples with two-needle hemstitch

Fig. 90

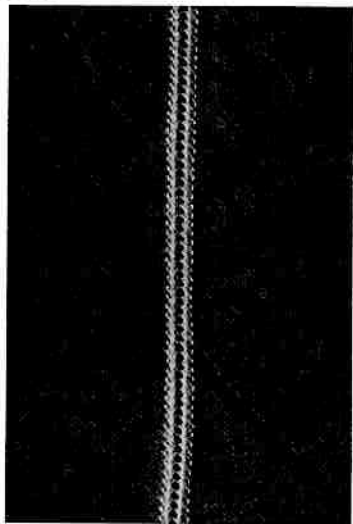

Fig. 91

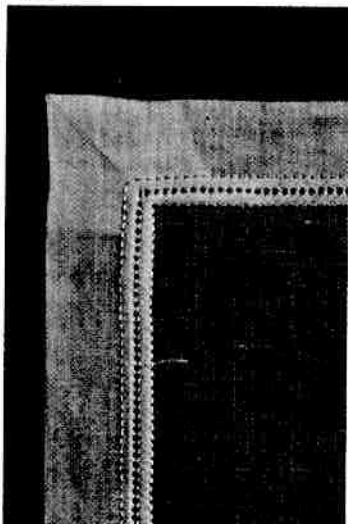
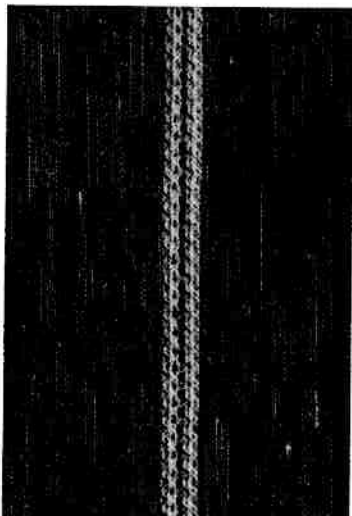

Fig. 92



## Monogramming

Here are two methods of embroidering initials:

1. Embroidering initials with feed dog lowered and guiding the embroidery frame by hand.
2. Embroidering with feed dog, but using the automatic satin stitch control executed by the machine.

In both cases some practise will be indispensable. An embroidery frame is always used, wherein the cloth is stretched. Only quite hard and stiff material will permit to work without an embroidery frame.

With the first method please observe the following adjustments:

- a) Insert a needle no. 70. According to the fineness of the fabric a correspondingly thinner needle will be used.
- b) Insert the wool darning foot.
- c) Lower the dog feed.
- d) Thread the machine. – For the upper thread take embroidery yarn no. 100 (f. i. DMC-yarn no. 100),

For the under thread use embroidery yarn no. 100.

- e) Place material into embroidery frame in such a way that the initials designed come to lie right in the middle of said embroidery frame.
- f) Adjust the width of stitch (zigzag width) according to the size of the initials. Stitch length is set almost upon zero.

After having placed the embroidery frame under the needle, the under thread should be brought up. Lower sewing foot. Start machine and keep it running smoothly at a fair speed, thus achieving the best results. Guide the frame with both hands slowly and steadily along the designed initials, without turning it.

After some practising initials can be embroidered also without the wool darning foot. Fig. 93 illustrates a few examples of initials.

With the second method the same adjustments are made as described above for the first one, with the following exceptions:

- a) insert the embroidery foot instead of the wool darning foot;

- b) instead of lowering the feed dog, this device must remain in working position;
- c) adjust cloth feed on a small stitch length, which can be made with the aid of the satin stitch control;
- d) adjust stitch width according to size of initial to be embroidered.

Here too the initial is designed onto the fabric; after having spanned the fabric into the frame, the initial should be right in the middle of the frame, just under the needle.

As illustrated in fig. 94, you begin to sew edge A and after completion, having reached the top of the initial, stop the machine, leave the needle stuck in the fabric with stitch to the right, and turn the embroidery frame round the needle, until the direction towards edge B is reached.

Now you can sew edge B. When swiveling anew, after having reached the required length, let the needle in the left stitch and turn embroidery frame into the new direction.

In that case you will not sew over the already sewn edge or part of it, but leaving a gap, thus producing a break in the outlines; this will be necessary for shaping many letters of the alphabet. In many cases the letters cannot be stitched in one go. If breaks are necessary, a few small stitches with

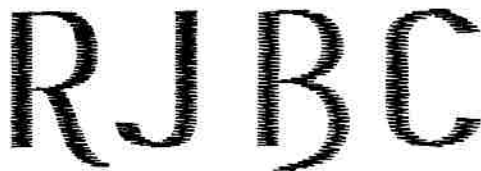

Fig. 93

stitch width zero should be made at the end of every finished edge in order to secure the seam, but when you begin with stitching a novel edge, this has to be done with the same width of stitch like the first one, until the initial is finished.

Various and really effective results can be obtained by means of stitching another seam along the outlines of a letter, but with a narrower stitch. Eventually this can be done with a yarn of a different colour, oversewn with the use of an inlay thread, as has been illustrated in Fig. 94 a.



Fig. 94



Fig. 94 a

## English Embroidery

(Available against extra charge)

The complete equipment for eyelet embroidery, which is not part of the standard accessories, comprises the following components:

- |                 |   |
|-----------------|---|
| no. 53 06 62    | Eyelet embroidery foot                        |
| no. 53 06 60    | Needle plate complete with slide<br>for holes |
| no. 54 12 01 01 | Embroidery ring                               |
| no. 54 11 05    | Square piercer                                |
| no. 54 11 06    | Round piercer                                 |

This simple device allows the sewing of fashionable eyelet and round embroideries on the BERNINA-Record.

With its aid different hole sizes can be surrounded, and round embroideries up to a diameter of approximately one inch can be produced. During sewing around the stitch width may be varied at will.

For eyelet embroidery work arrange the machine as follows:

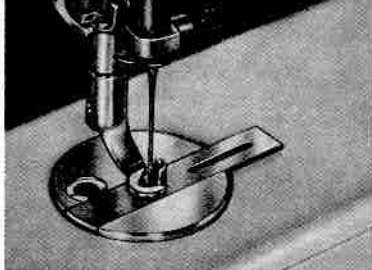

Fig. 95

Position for slide when executing eyelet embroideries

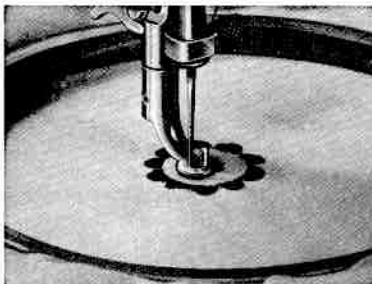

Fig. 96

Embroider within the embroidery frame

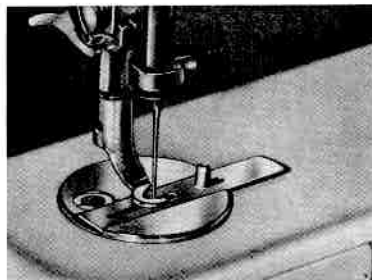

Fig. 97

Position of slide for circular embroideries

1. Set needle stitch to left position by turning grip 17, - see fig. 2 - to the left.
2. Lower feed dog by turning reversible knob 23 (see fig. 2) to darning symbol.
3. The normal stitch plate must be changed against the eyelet embroidery stitch plate which is foreseen with exchangeable slide provided with guide journals, whereby also the special embroidery presser foot must be inserted.

Always use the embroidery frame

We recommend winding strips of cloth around its outer ring to obtain a better tension of the fabric to be embroidered and to prevent damage to it.

Only after having clamped the cloth punch the holes with the piercers supplied.

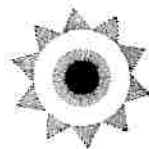



It will be of advantage to previously mark the holes on the fabric. Then place the material under the eyelet embroidery foot, so that the guide pin of the slide comes to lie in the hole. As has been mentioned heretofore, the needle should be set into left position.

For both top and bottom embroidery thread no. 60-80 is to be used, which will give the best results in even sewing around the holes.

For eyelet embroidery the thread tension is of utmost importance. The under thread tension should be slightly stronger than that of the upper thread, so that the thread knots will only show on the lower face of the material.

The slide in the embroidery plate should be positioned in such a way that the needle, when making a right-hand stitch, enters in the recess of the guide pin just beyond the edge of the material.

This setting is altered according to stitch width and should therefore be repeated every time. Then allow the machine to operate at regular speed and turn at the same time three or four times around the guide pin at the same regular speed in clockwise direction.

Then set zigzag knob 8 (see fig. 2) upon zero position and secure the thread by a few stitches. These binding stitches should be parallel to the embroidery stitches, so that they remain practically invisible.

When the slide of the stitch plate is reversed, as shown in fig. 97, the guide pin can be used as a centre in sewing circular embroideries. In doing so the needle pierces through the long slot of the slide.

By changing the density of the stitches, i. e. by varying the speed of rotation of the embroidery ring during the stitching, and using threads of most different colours, very attractive and varied patterns can be produced, enhancing by the way the look of the eyelet embroideries.

As a rule kindly observe when executing eyelet embroidery works that the holes of the same size should always be finished successively, so that the slide need not be changed too frequently.



## HOW TO AVOID MACHINE TROUBLE

First we should like to give you some hints how machine troubles might be avoided, what may be their cause, and how to remedy them.

### 1. On principle ...

In most cases troubles are resulting from faulty manipulations of the machine. However, should other causes be presumed, the machine has to be examined, whether:

- a) the needle is correctly set. The long groove should always be in front and the needle threaded from front to back;
- b) the needle is the correct size for the thread; for darning of fine fabrics use needle size no. 70, for other sewing work needle size no. 80 or no. 90. Re sizes of needles and threads see page 13;
- c) the machine is properly cleaned. Remove free arm cover plate and clean all lint. Cleanse feed dog with the brush;
- d) shuttle race is properly cleaned. This cleansing is made in the following way:

For proper care and thorough cleansing of the machine the shuttle should be removed from time to time out of its race.

Raise needle bar to its uppermost position and with the thumb of left hand press down spring lever part 55 to the left of shuttle race, thus enabling the locking bridge 56 to swivel down together with shuttle race cover 57. After having withdrawn bobbin case with shuttle, it will be easy

Fig. 98

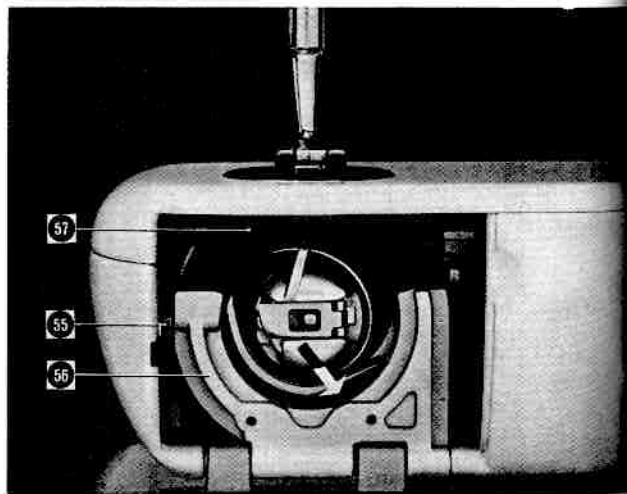

to clean the shuttle race from jammed thread ends and lint, using the brush to do so.

Never use hard instruments, such as screwdrivers a. s. o. to perform this, as otherwise the shuttle race might get damaged. After this cleansing has been done, replace first shuttle, then close locking bridge 56 with shuttle race cover 57, and finally insert again bobbin case. Make sure that the locking bridge has engaged correctly;

- e) the shuttle race has been oiled correctly with a few drops of oil (see fig. 20);
- f) no thread ends are stuck between the thread tension discs;
- g) no thread ends are jammed under the bobbin case tension spring;
- h) the machine can easily be started with handwheel.

## 2. The causes of upper thread breaking

may be the following:

- a) The use of badly polished needles of inferior quality. Needles should always be purchased at a BERNINA shop;
- b) Needle incorrectly set. Long groove must always be in front;
- c) Needle is bent or blunt;
- d) The relation between size of thread and needle is not the right one (see table on page 13);
- e) Upper tension thread is too tight;

- f) Thread of bad quality, full of knots.

Thread dried out by too long storage.

Thread should never be stored in heated rooms.

If the machine has been in use for a long time, thread breaking may have a cause only a competent sewing machine mechanic can deal with;

- g) Stitch plate hole has been damaged by the needle and requires re-polishing;
- h) Shuttle point is damaged.

## 3. Cause of under thread breaking

can be:

- a) Under thread tension too tight;
- b) Under thread badly wound on bobbin;
- c) Bobbin is deformed and jamming in the case;
- d) Stitch plate hole has been damaged by the needle and requires re-polishing (ask the expert!).

## 4. Missing stitches

may be caused by:

- a) using unsuitable needles of other make. Always use needles of system 705;
- b) needle is bent;
- c) needle not correctly set; long groove must always be exactly in front; when inserting needle push it up as far as it will go;

- d) needle of inferior quality or badly polished;
- e) size of needle and size of thread are not in good relation together.

### 5. Needle breaking

may have the following causes:

- a) needle holder screw not securely tightened;
- b) upper thread tension too tight;
- c) the material has been pulled from under the presser foot towards the front, after having finished with the sewing work. Thus the needle got bent. Always remove the material from the machine by pulling it back from under the presser foot base;
- d) size of needle and size of thread are not in correct relation together. Often the needle is too thin for too thick a yarn, whereby the needle becomes bent;
- e) use of thread of inferior quality, unevenly twisted, or having knots;
- f) during sewing do not pull the material too hardly towards the back.

### 6. Faulty seams

- a) A faulty, uneven seam is formed:
  - 1. if there are ends of threads between the thread tension discs;

- 2. if there are thread ends under the bobbin case tension spring;
- 3. if the bobbin is deformed and jamming in the bobbin case;
- 4. if the thread is not evenly manufactured;
- 5. if the shuttle is not oiled;

- b) when sewing tricot of other knit goods make sure of the following items:

- 1. tricot should always be basted with darning thread, never with basting thread;
- 2. use perfect needles of size no. 70 or 80;
- 3. the thin area of the material should be placed to the left under the presser foot;
- 4. sizes of needles and thread should be in perfect relation together;
- 5. if the zigzag stitch seams not to be elastic enough, adjust for a larger width and a shorter stitch length in order to enlarge the elasticity of the seam;

- c) puckered seams:

in most cases the cause of puckering is too tight a tension on upper and under thread. When sewing tricot and other knit goods the material must never be pulled to the back with the hands; otherwise the seam gets puckered. Care has to be taken

that when sewing this kind of material the feed towards the presser foot be always sufficient, by means of lightly pushing the tricot on both sides of said presser foot.

## **7. The machine operates too slowly**

*The motor does not work correctly (ask the expert!):*

- a) tension of drive belt may be too tight or too loose (ask the expert!);
- b) the sewing machine has been idle for a long time in a moistened room. In such a case it must be placed in a room with normal temperature for some time and subsequently the machine should be oiled;
- c) if oil of doubtful quality has been employed, the machine became gummed. If lubrication of the sewing machine at the oil points with petrol does not improve its condition, the machine must be demounted and cleaned (ask the expert!).

## **General notice**

To prevent any damage to the presser foot, place a piece of material under it, as far as possible. If the machine will be idle for some time, you may do alike.

In order to avoid thread jamming, make sure that after every sewing operation the thread take-up lever is raised to its uppermost position. This precaution will greatly help to avoid any troubles.

*Modifications of construction as against text and clichés are reserved.*



Notes of BERNINA Representative  
regarding instructions, home calls, and possible warranty work

Date	Notes

Notes of BERNINA Representative  
regarding instructions, home calls, and possible warranty work

Date	Notes



## Normal Accessories for Model 730

Part. no.	<i>In Sewing Kit:</i>		<i>In Carrying Case:</i>
53 06 03 04	1 zigzag presser foot with hinged base		1 sewing table
53 16 09 00	1 zigzag embroidery foot	53 11 10 00	1 motor cable with plug
53 06 08 00	1 large hemmer	53 10 60 00	1 pedal starter (only with machines provided with pedal starting device)
53 06 82 03	1 blindstitch foot		1 instruction book
53 06 15 00	1 edger with quilting guide		
53 06 36 02	1 pintuck foot with 7 grooves		
63 06 18 01	1 buttonhole foot		
53 06 70 00	1 darning foot		
53 06 29 01	1 wool darning foot		
53 07 61 00	6 bobbins, one of which being on machine		
			<i>Available against extra charge:</i>
53 11 32 00	1 small screwdriver	53 06 48 01	1 narrow hemmer
60 11 33 00	1 special screwdriver	53 06 46 00	1 gathering foot
53 11 34 00	1 buttonhole opener	53 06 18 02	1 special buttonhole foot
53 11 37 00	1 wooden support	53 16 03 00	1 zipper inserting foot
53 11 12 00	1 plastic oiler	53 16 13 00	1 zipper inserting foot, adjustable
53 11 28 00	1 brush	53 06 13 00	1 feller foot
53 12 00 02	1 darning attachment for stockings	53 06 44 01	1 plain stitch presser foot
	1 pack of assorted needles of the 705 system	53 06 11 00	1 combination roll and scalloped roll hemmer
	1 twin needle, 2 mm	53 06 20 00	1 button presser foot

## Normal Accessories for Model 731

Part. no.	<i>In Sewing Kit:</i>		<i>In Carrying Case:</i>
53 06 03 04	1 zigzag presser foot with hinged base		1 sewing table
53 16 09 00	1 zigzag embroidery foot	53 11 10 00	1 motor cable with plug
63 06 18 01	1 buttonhole foot	53 10 60 00	1 pedal starter (only with machines provided with pedal starting device)
53 06 70 00	1 darning foot		1 instruction book
53 06 29 01	1 wool darning foot		
53 07 61 00	6 bobbins, one of which being on machine		
53 11 32 00	1 small screwdriver		
53 06 82 03	1 blindstitch foot		
53 06 36 02	1 pintuck foot with 7 grooves		
60 11 33 00	1 special screwdriver		
53 11 12 00	1 plastic oiler		<i>Available against extra charge:</i>
53 11 28 00	1 brush	53 06 48 01	1 narrow hemmer
53 11 34 00	1 buttonholer opener	53 06 46 00	1 gathering foot
53 11 37 00	1 wooden support	53 06 18 02	1 special buttonhole foot
53 12 00 02	1 darning attachment for stockings	53 16 03 00	1 zipper inserting foot
	1 pack of assorted needles of the 705 system	53 16 13 00	1 zipper inserting foot, adjustable
		53 06 44 01	1 plain stitch presser foot

## Normal Accessories for Model 732

Part. no.	<i>In Sewing Kit:</i>		<i>In Carrying Case:</i>
53 06 03 04	1 zigzag presser foot with hinged base		1 sewing table
53 16 09 00	1 zigzag embroidery foot	53 11 10 00	1 motor cable with plug
63 06 18 01	1 buttonhole foot	53 10 60 00	1 pedal starter (only with machines provided with pedal starting device)
53 06 70 00	1 darning foot		1 instruction book
53 06 29 01	1 wool darning foot		
53 07 61 00	6 bobbins, one of which being on machine		
53 11 32 00	1 small screwdriver		
60 11 33 00	1 special screwdriver		
53 11 12 00	1 plastic oiler		<i>Available against extra charge:</i>
53 11 28 00	1 brush		
53 11 34 00	1 buttonholer opener	53 06 48 01	1 narrow hemmer
53 11 37 00	1 wooden support	53 06 46 00	1 gathering foot
53 12 00 02	1 darning attachment for stockings	53 06 08 12	1 special buttonhole foot
	1 pack of assorted needles of the 705 system	53 16 03 00	1 zipper inserting foot
53 06 36 02	1 pintuck foot with 7 grooves	53 16 13 00	1 zipper inserting foot, adjustable
		53 06 44 01	1 plain stitch presser foot

FR. GEGAUF LTD., BERNINA Sewing Machine Factory, STECKBORN

