

10 x 10 cm

4 x 4 Inch

1A

1

2A

1 line/
Beleglijn

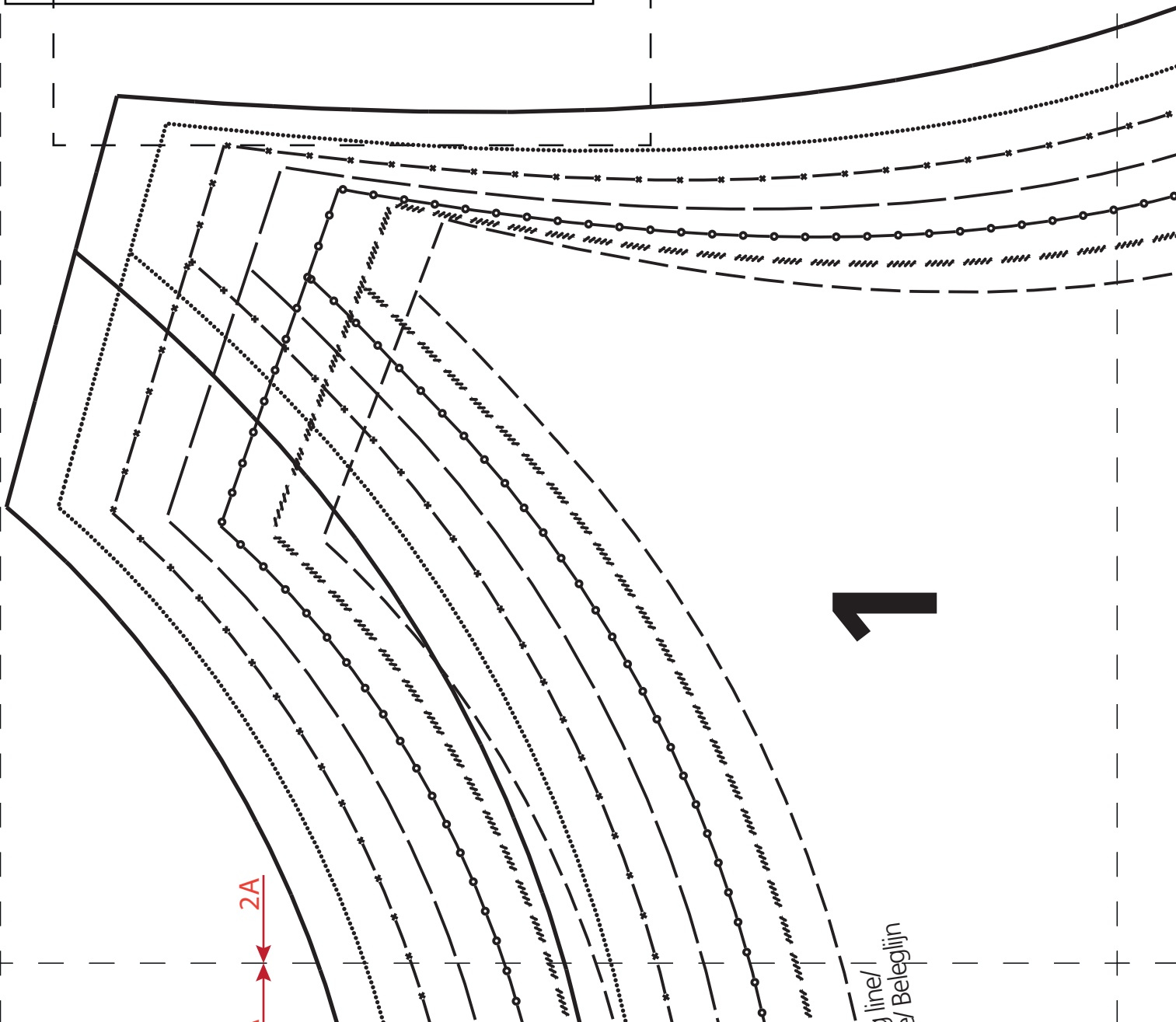

A

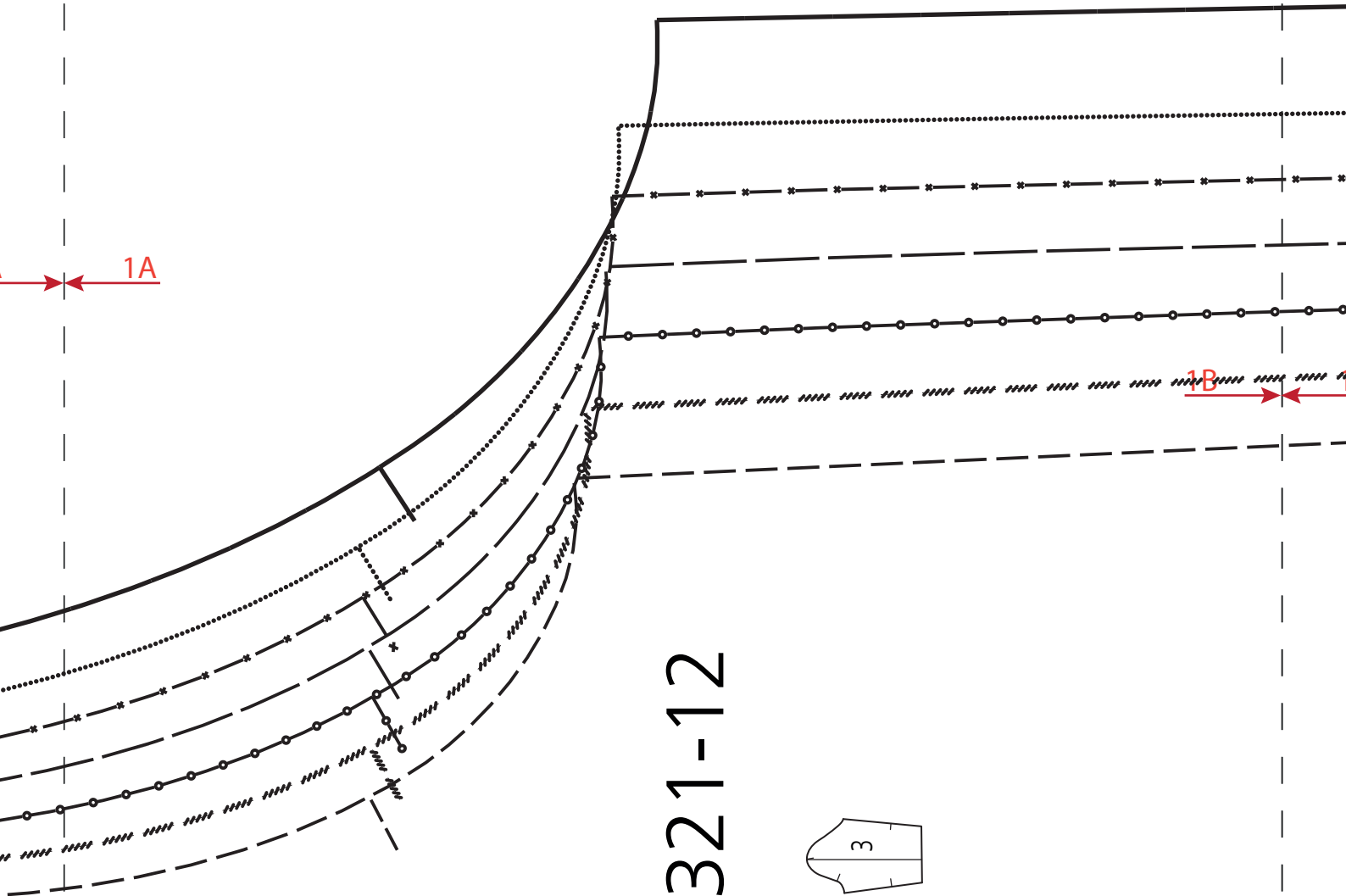

Dress „Swantje“ 321-12

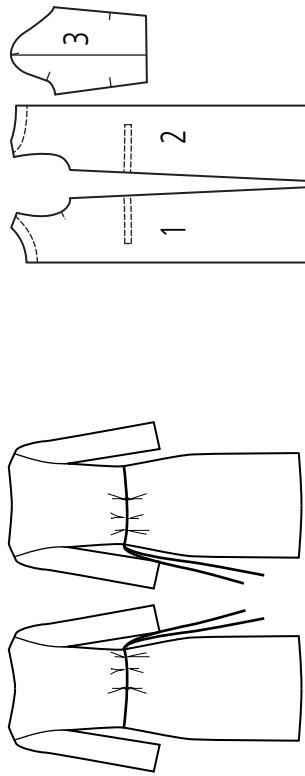

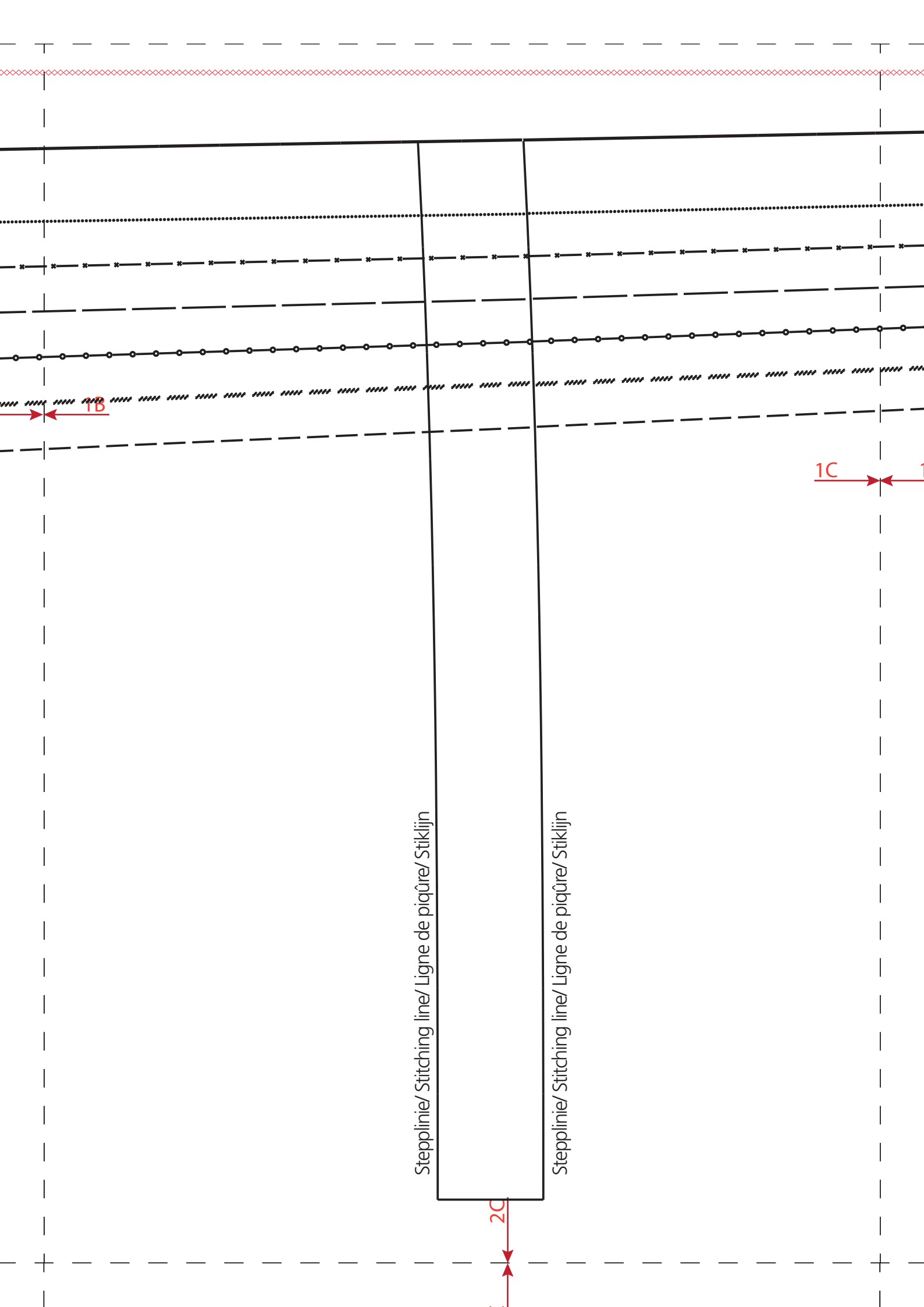

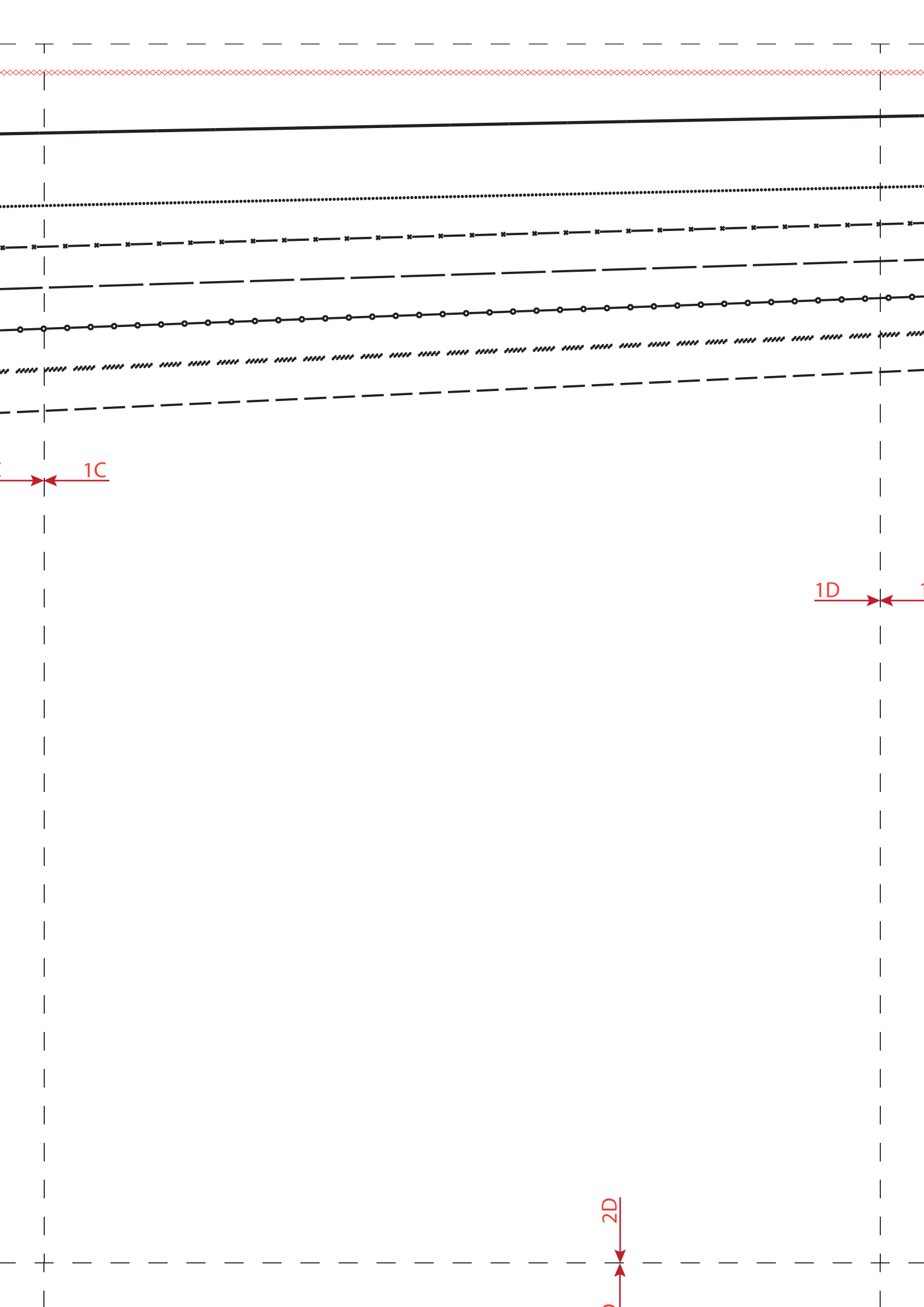

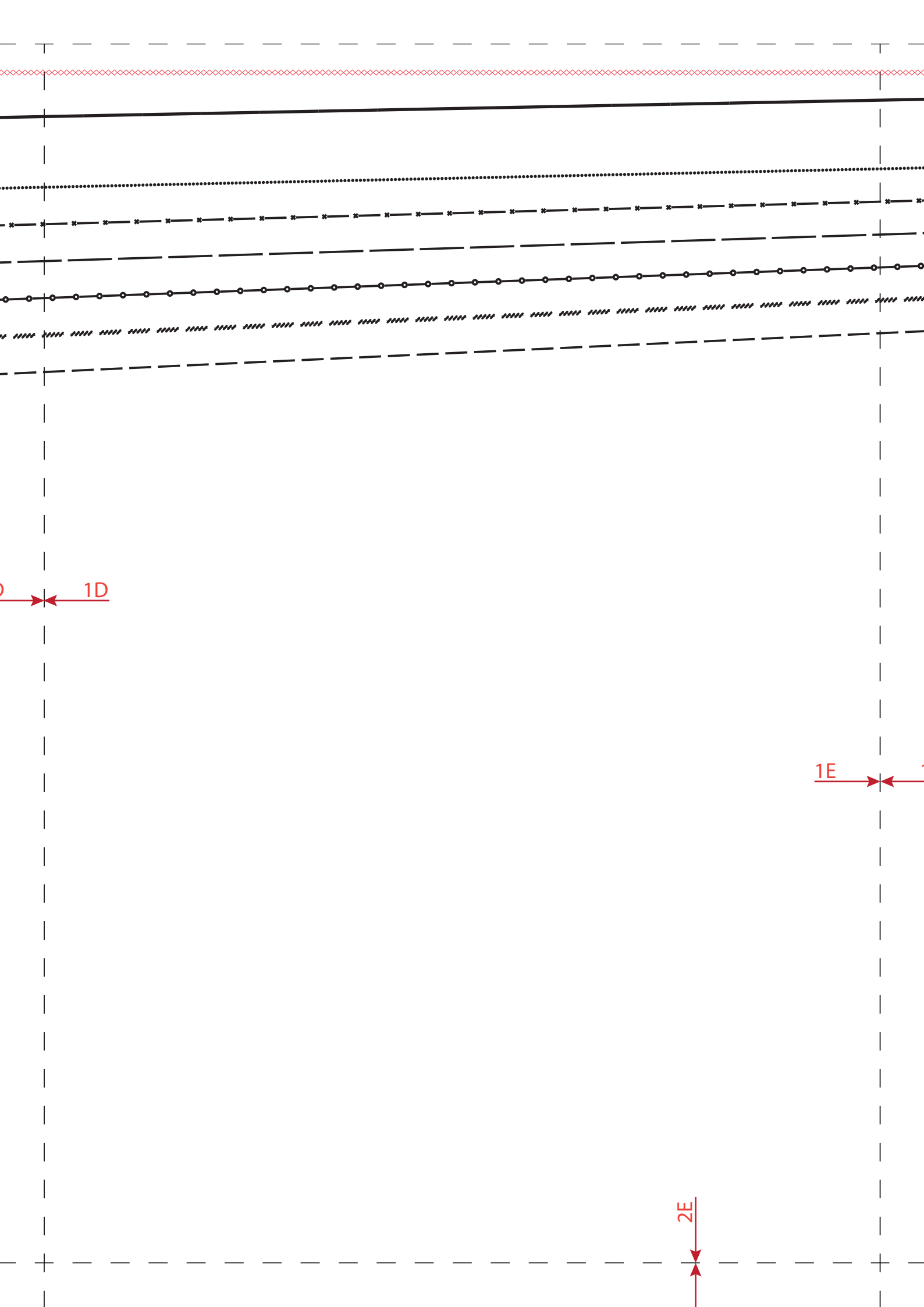

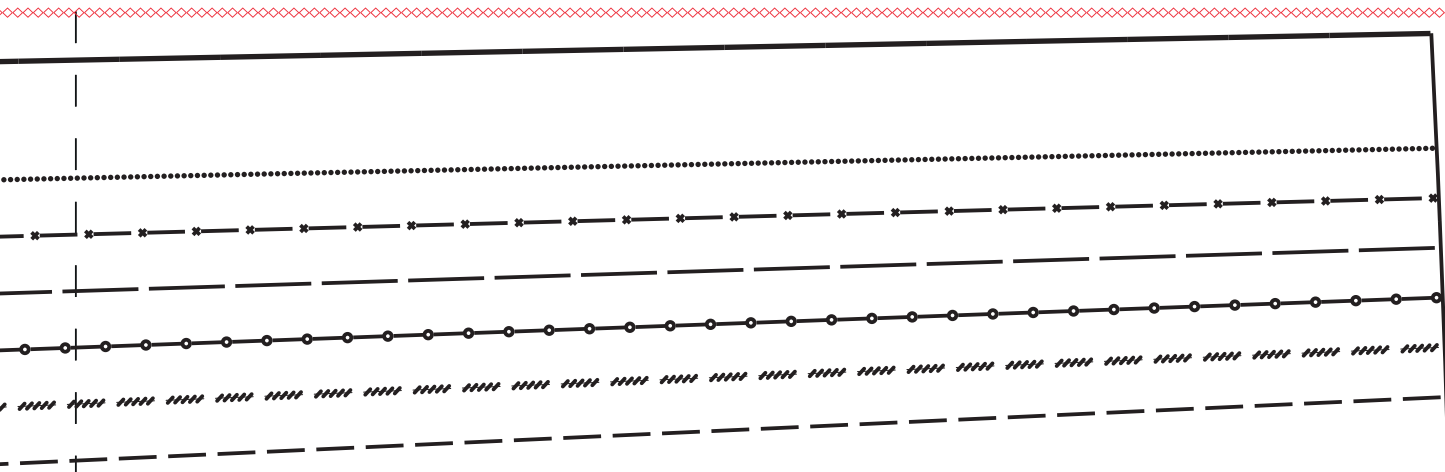

1E

2F

2A

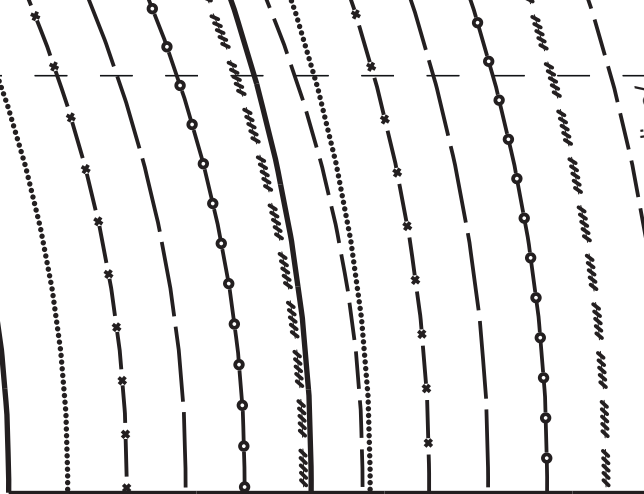

Besatzlinie/ Facing line/
Ligne de Parementure/ Beleglijn

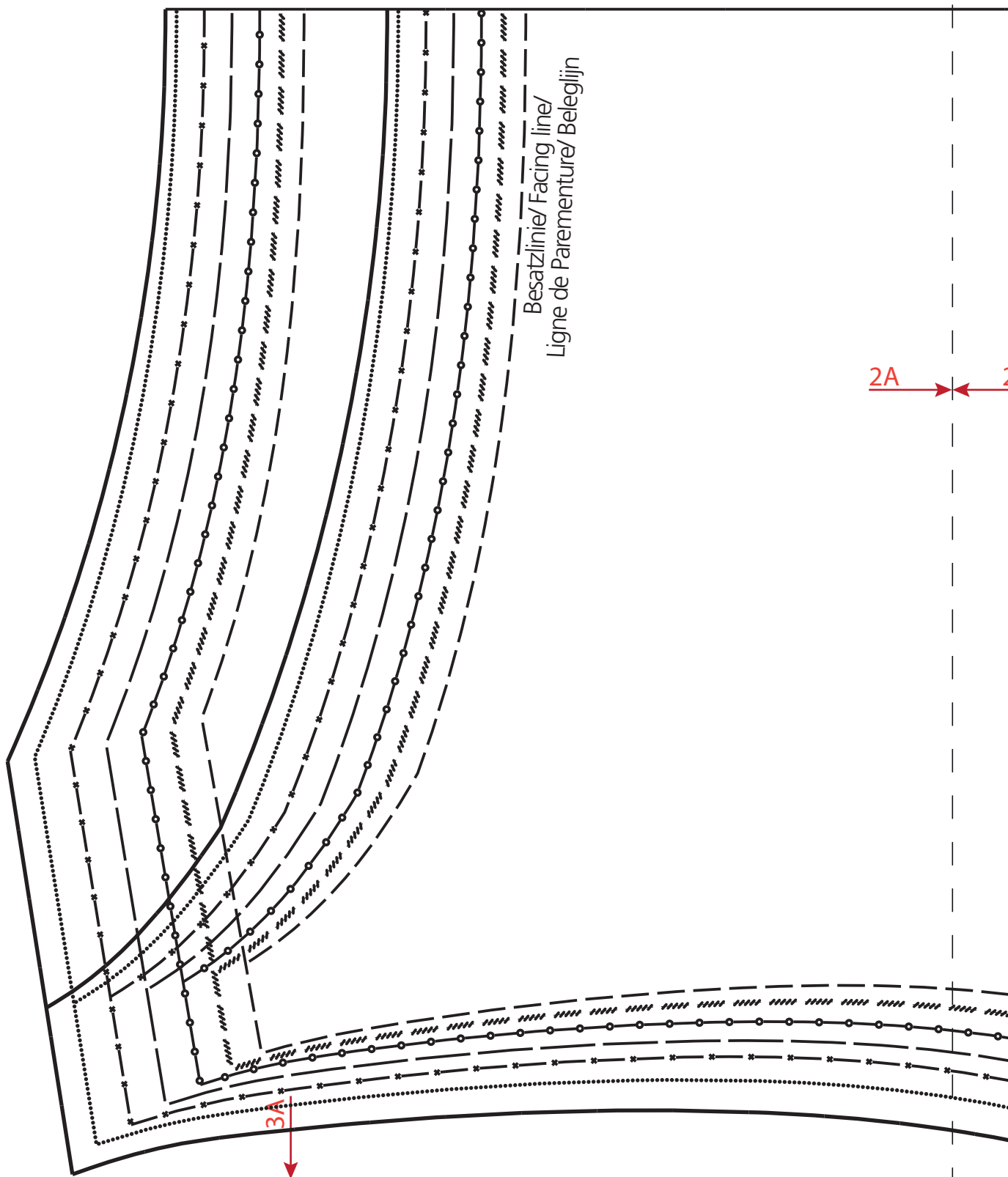

Besatzlinie/ Facing line/
Ligne de Parementure/ Beleglijn

2A

2A

endroit pli droit fil/Middenvoor stofvouw draadrichting

pli droit fil/Middenachter stofvouw Draadrichting

2B

2B

2A

2

3B

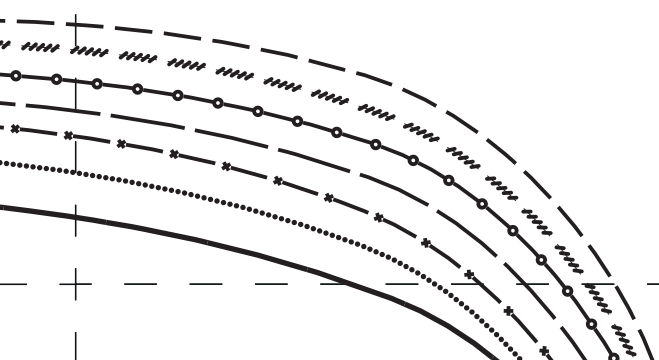

Rückwärtige Mitte Stoffbruch Fadenlauf / Centre back fold straight grain/ Milieu envers pli droit fil/

Vordere Mitte Stoffbruch Fadenlauf/ Centre front fold straight grain/ Milieu endroit pli d

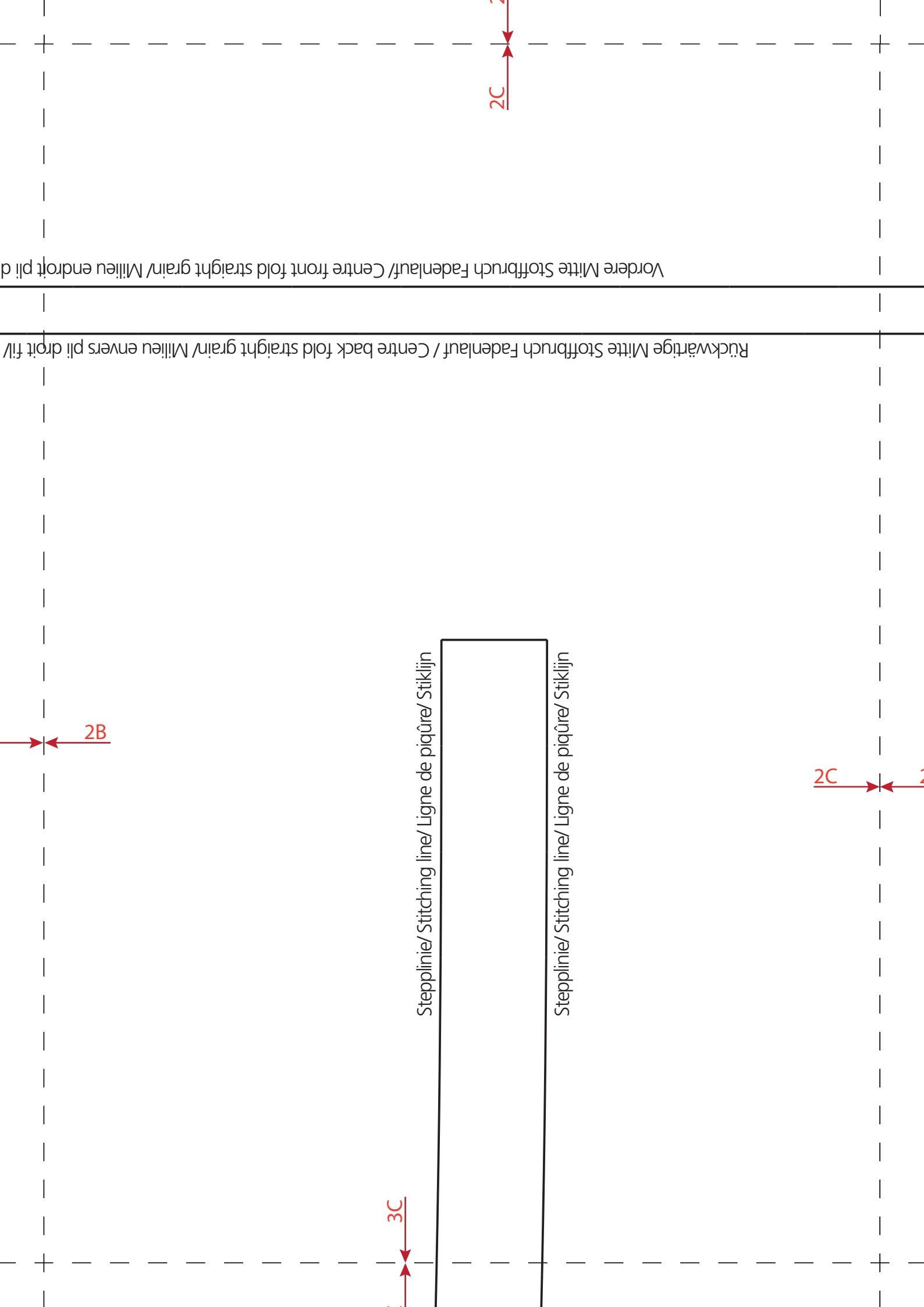
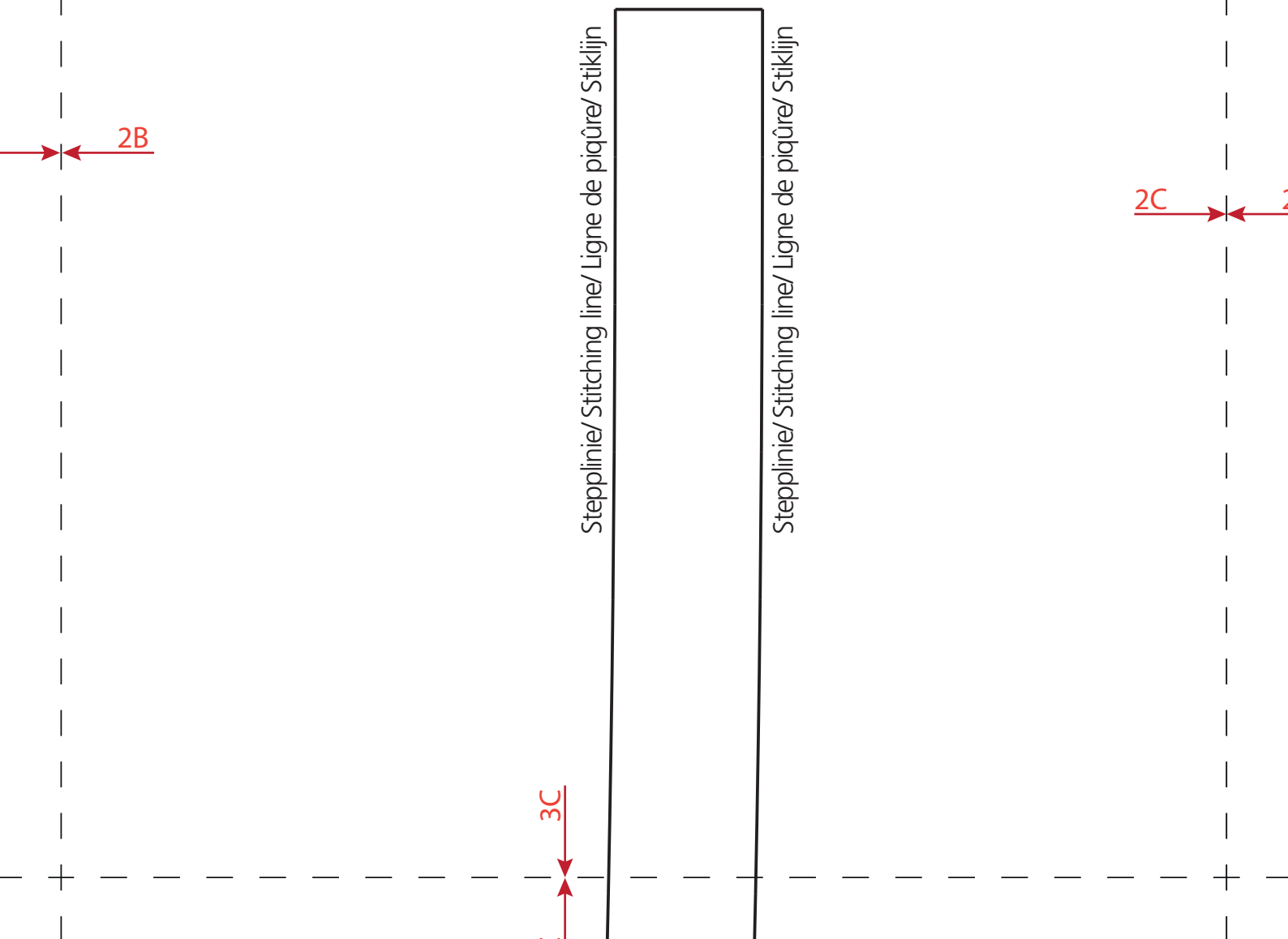

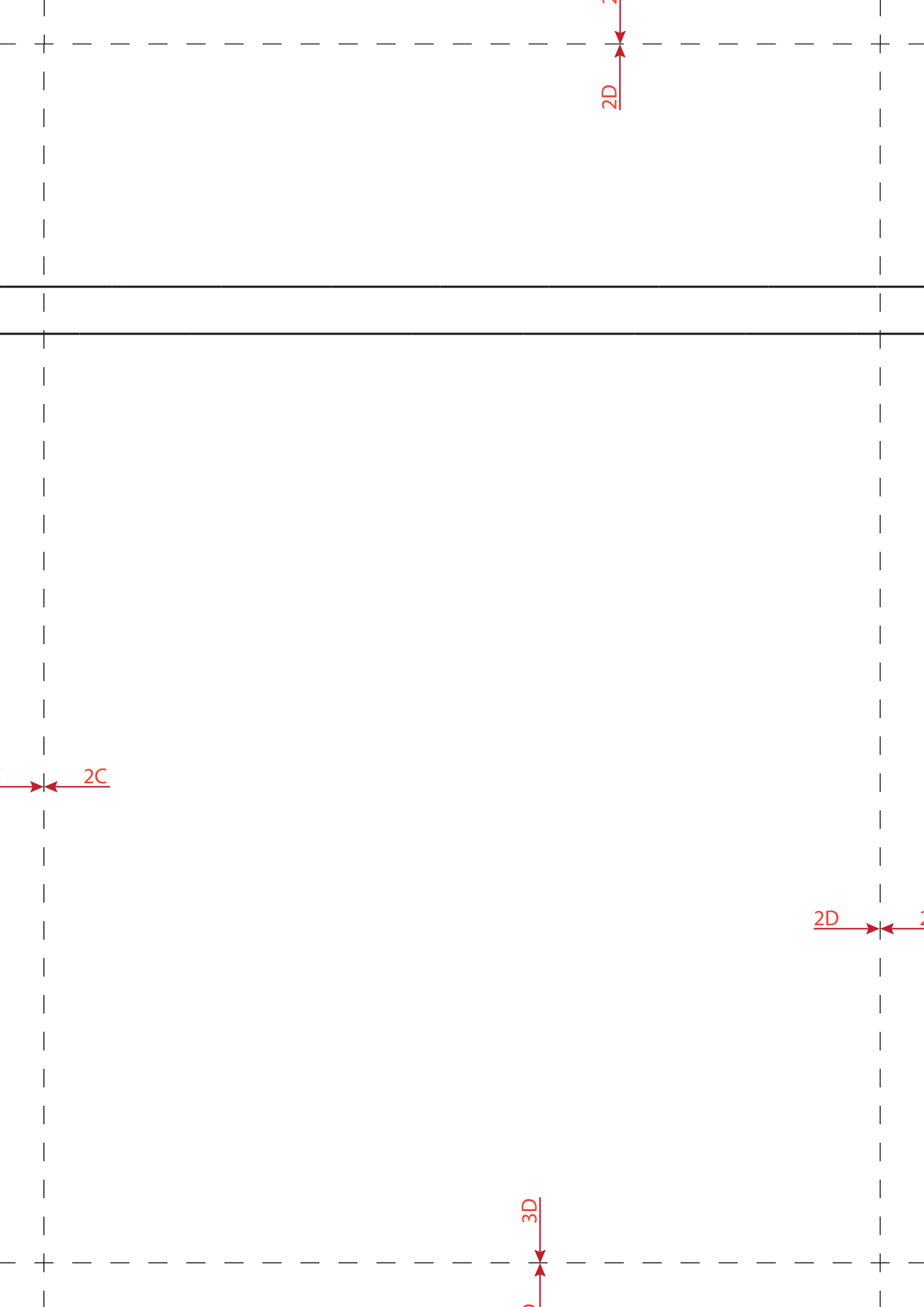

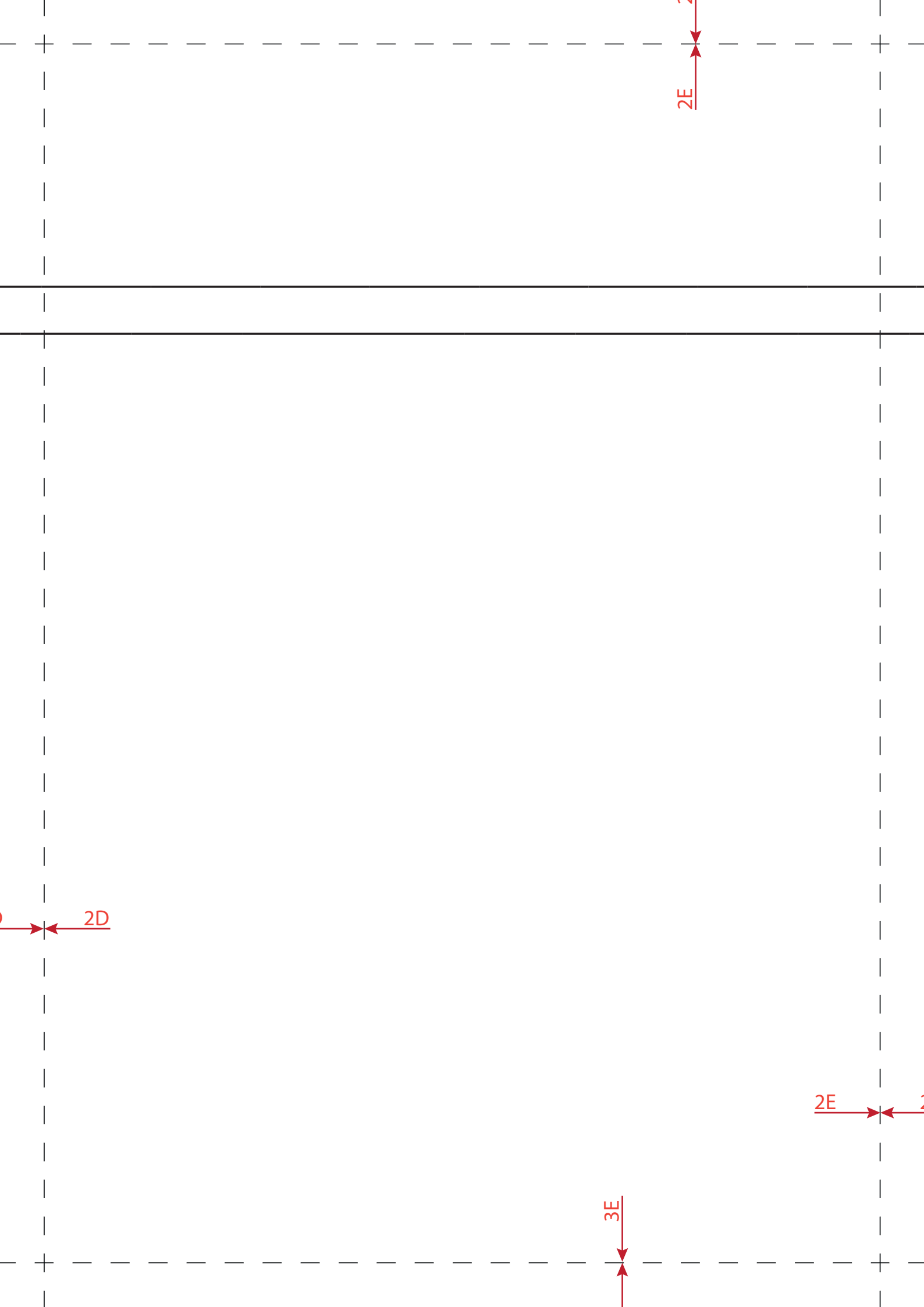

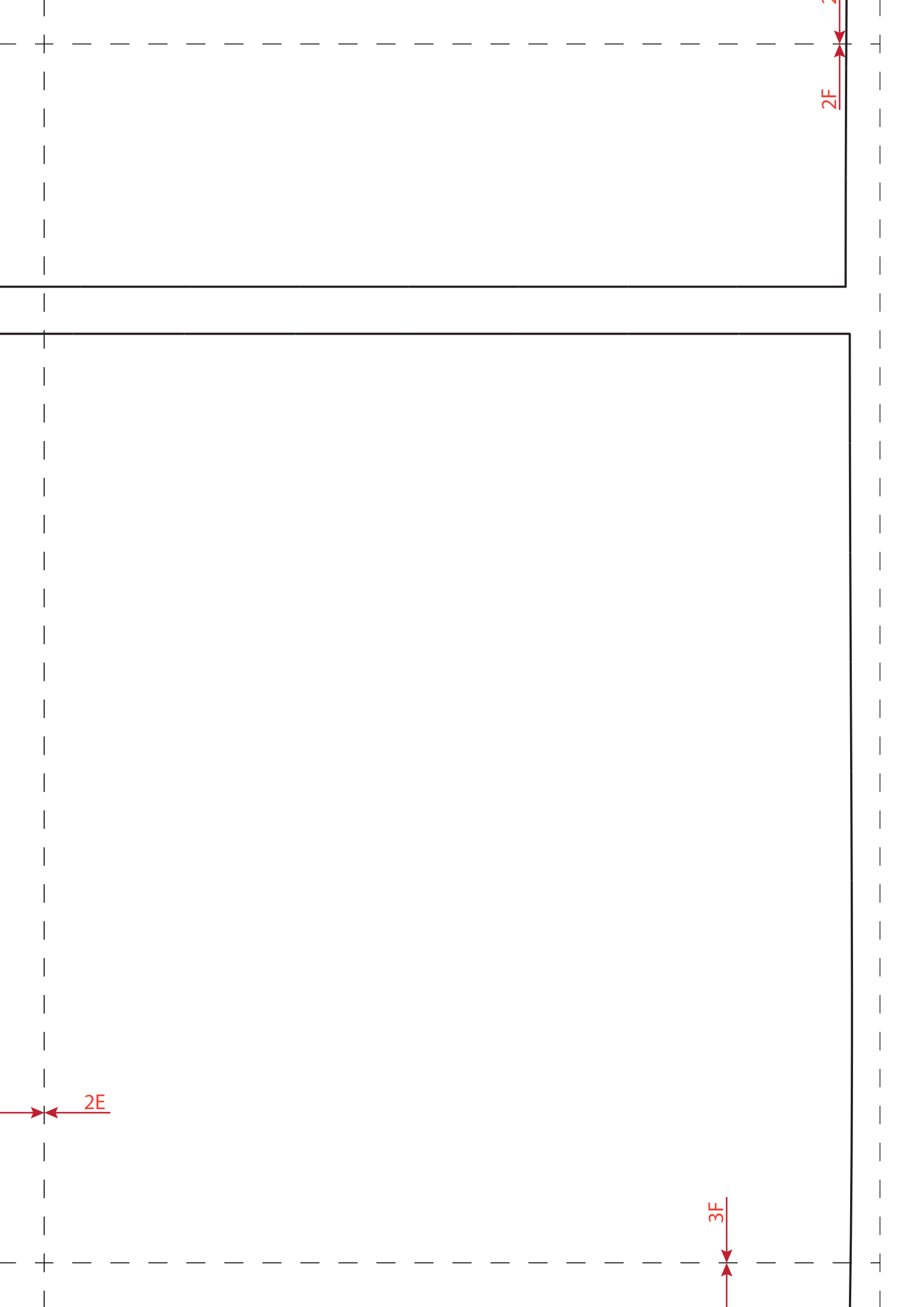

Keine Inspiration mehr versäumen – mit einem Abo!
No more missing inspiration – with a subscription!



Ja, ich möchte die Inspiration ab der nächsten Ausgabe für 1 Jahr abonnieren (3 Hefte pro Jahr).

Yes, I would like to subscribe to Inspiration from the next issue for 1 year (3 issues per year).

Jeweils im Januar erscheint das Frühjahrsheft, im Mai das Sommerheft und im September die Herbst/Winterausgabe. In allen Ausgaben sind Schnittmuster enthalten.

The spring issue is published in January, the summer issue in May and the autumn/winter issue in September. All issues contain pattern plans.

Land/ Country	Print	Digital	Sprache/ Language
<input type="checkbox"/> Schweiz/ Switzerland	CHF 24	CHF 14	<input type="checkbox"/> Deutsch/ German
<input type="checkbox"/> Europa/ Europe	EUR 21	EUR 11	<input type="checkbox"/> Englisch/ English
<input type="checkbox"/> Übersee/ Overseas	USD 38/AUD 54	USD 14,50/AUD 24,50	<input type="checkbox"/> Französisch/ French
			<input type="checkbox"/> Niederländisch/ Dutch

alle Preise inkl. MwSt. und Porto/ All prices inclusive of VAT and postage

Name

Geburtsjahr (optional)/ Year of birth (optional)

Strasse, Nr./ Street, no.

PLZ, Ort/ Postal code, town

Telefon - E-Mail/ Telephone no. - Mail

Mein Abonnement beginnt mit der jeweils nächsten Ausgabe. Es läuft nach Erhalt von 3 Heften automatisch weiter, sofern ich nicht rechtzeitig vor Ablauf kündige.
Subscriptions normally begin with the next issue. Subscriptions are automatically renewed after 3 issues if not cancelled in time before their expiry.

- Ich bin damit einverstanden, dass BERNINA meine Daten zur Weiterverarbeitung an Dritte (insb. die medienwerkstatt ag, Schweiz) übermittelt, sofern dies erforderlich ist, um die vertragliche Leistung in Anspruch nehmen zu können.
 I agree that BERNINA may transfer my data to third parties (esp. the media workshop AG, Switzerland and Datatrans AG, Switzerland), if this is required in order to make use of the contractual service.
- Ich bin damit einverstanden, dass meine Daten für Zwecke der Direktwerbung von BERNINA verarbeitet und mit anderen Informationen, die von BERNINA für denselben Zweck erhoben wurden, verknüpft werden. Weitere Informationen kann ich in der Datenschutzerklärung (bernina.com) einsehen. Diese Einwilligung kann ich jederzeit kostenfrei widerrufen.
 I agree that my data will be processed for direct marketing purposes by BERNINA and will be linked with other information which have been collected by BERNINA for the same purpose. I can find further information in the privacy policy (bernina.com). I can revoke this consent free of charge at any time.

BERNINA International AG, Redaktion Inspiration, CH-8266 Steckborn, www.inspiration.bernina.com
 E-Mail: inspiration@bernina.com

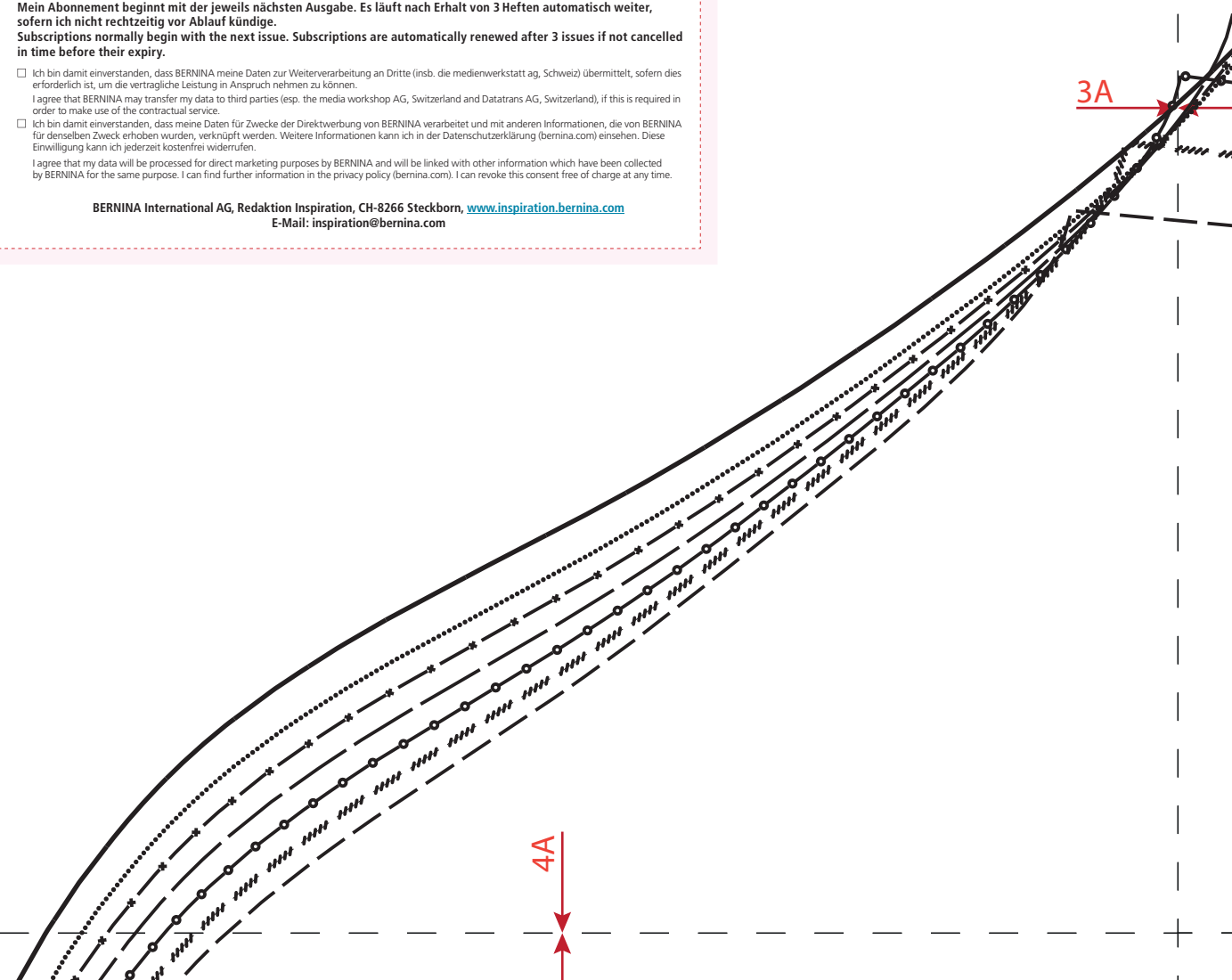

3A

3A

4A

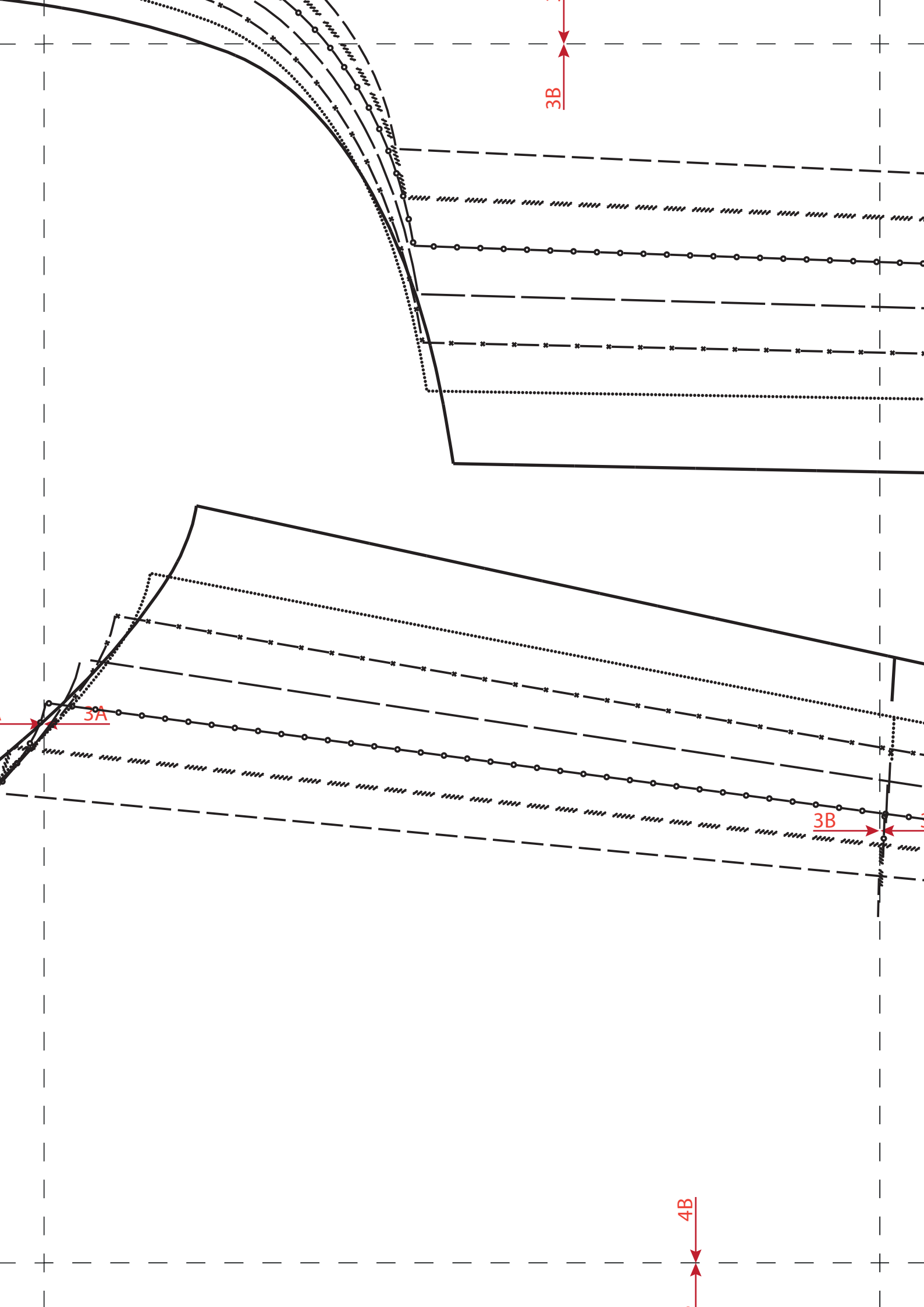

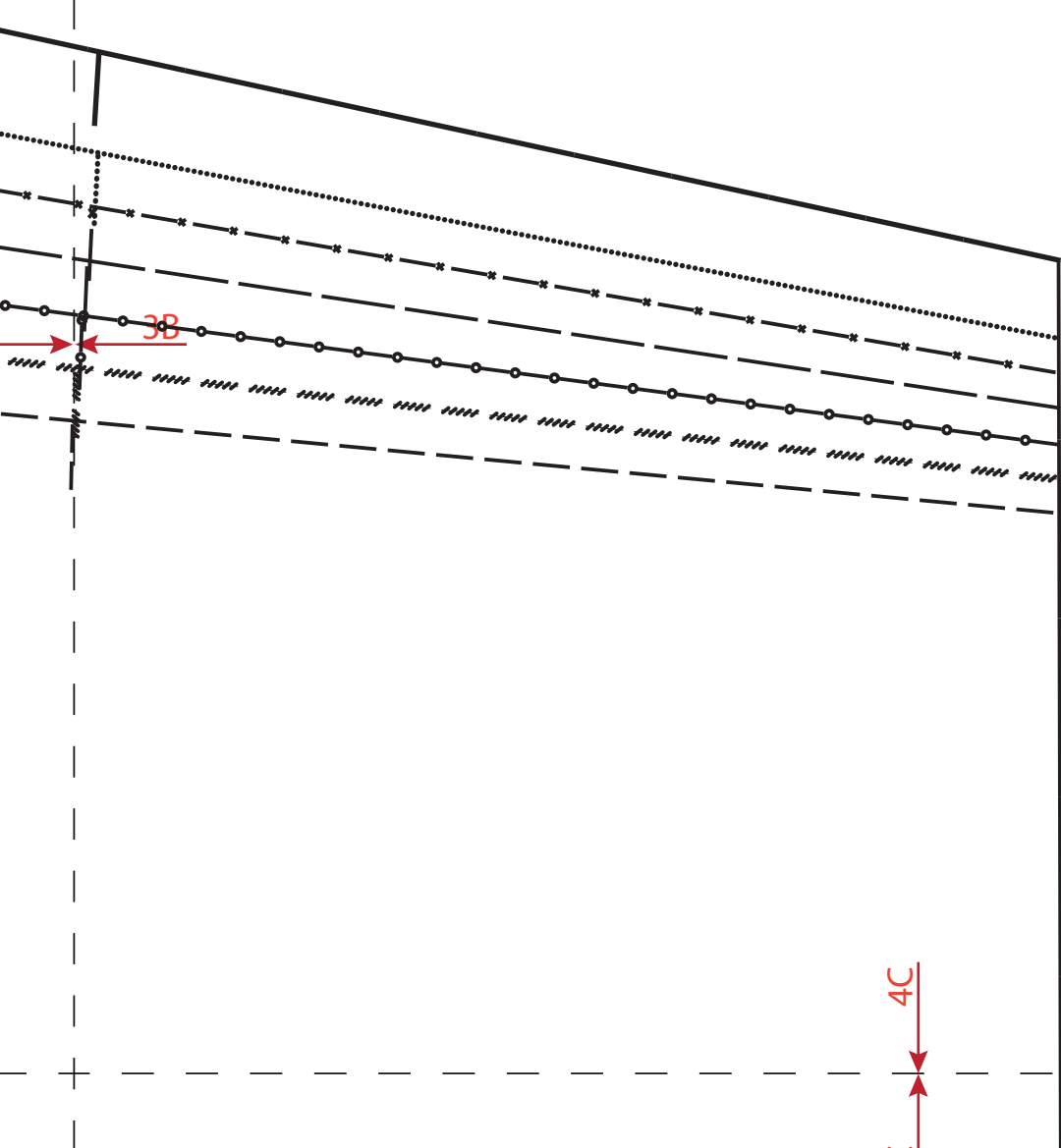
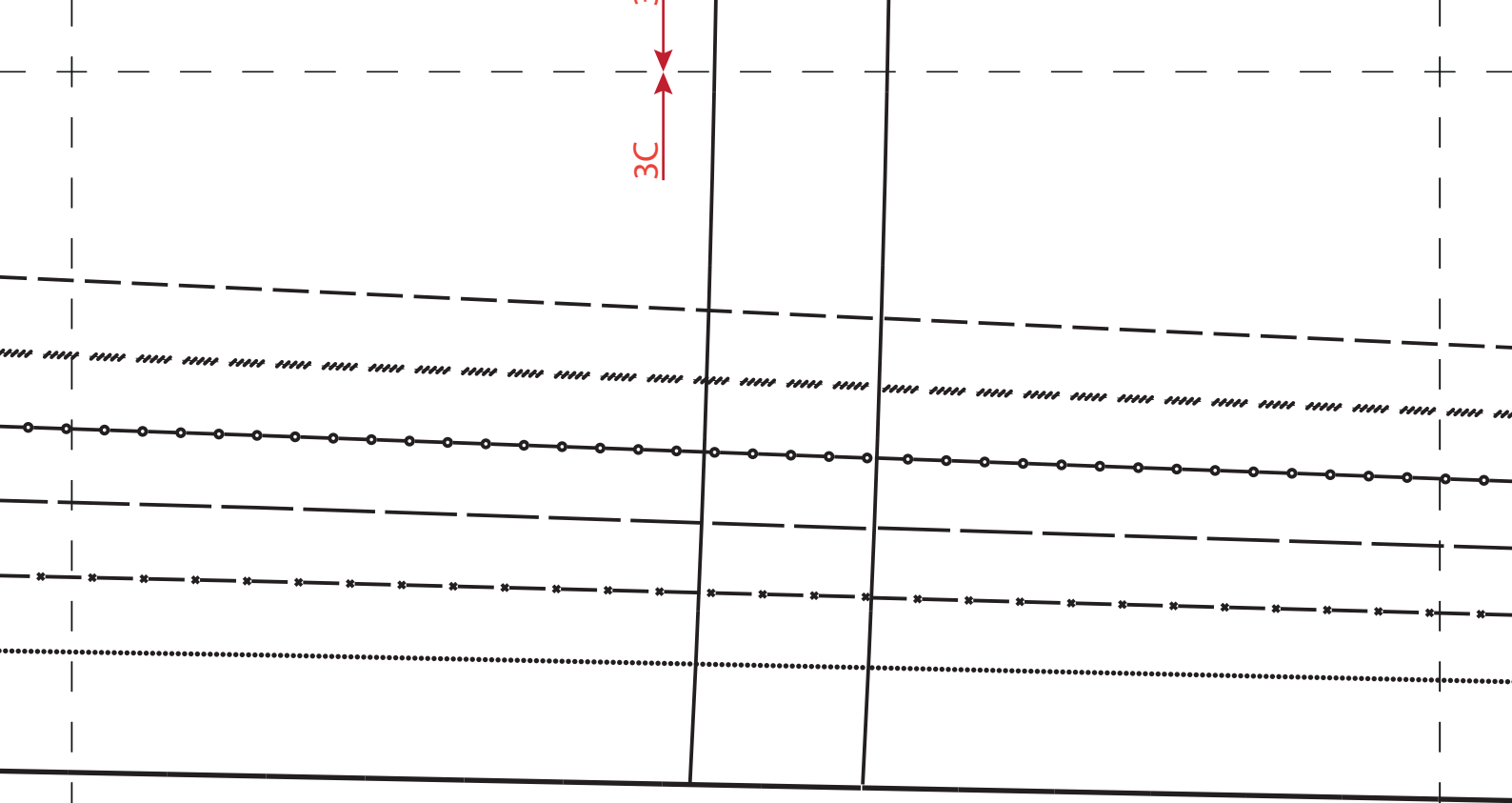

3D

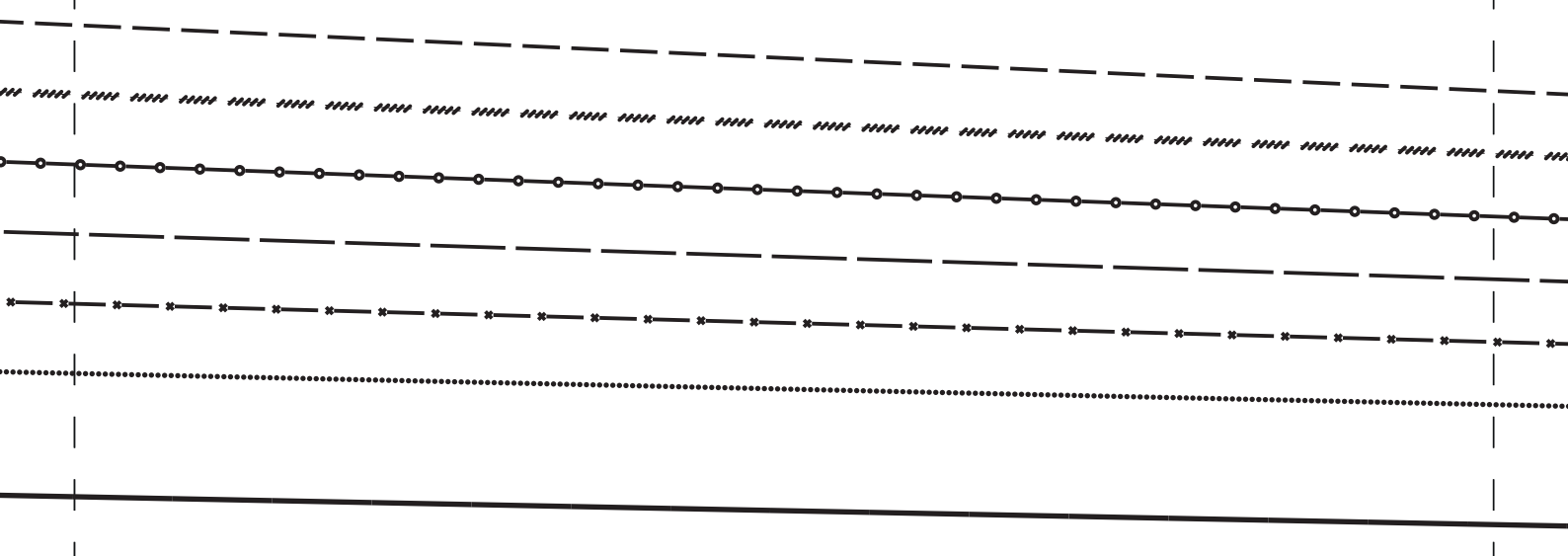

Für Körpergröße/ for height/ pour la taille/ Maten voor lichaamsgrootte 168 cm

Größe/ Size/ Taille/ Maat	34	36	38	40	42	44	46	48
Oberweite/Bust/ Poitrine/ Bovenwijdte	80	84	88	92	96	100	104	110
Taillenweite/ Waist/ Taille/ Tailleuwijdte	64	67	71	75	79	83	87	93
Hüftweite/ Hip/ Hanche/ Heupwijdte	90	93	96	99	102	105	108	114
Vord. Tailleng./ Front waist length/ Longueur taille devant/ Taillelengte voor	42	43	44	45	46	47	48	49
Rückw. Tailleng./ Back waist length/ Longueur taille dos/ Ruglengte tot taille	41	41	41	42	42	42	42	43

Legende/ Legend/ Légend

Größe/	---	34
Size/	---	36
Taille/	---	38
Maat	----	40
	---	42
	---	44
	46
	---	48

For height 66 inch:

Taille	34	36	38	40	42	44	46	48
Bust	31,5	33,0	34,6	36,2	37,8	39,4	40,9	43,3
Waist	25,2	26,4	28,0	29,5	31,1	32,7	34,3	37,0
Hip	35,4	36,6	37,8	39,0	40,2	41,3	42,5	44,9
Front waist length	16,5	17,0	17,3	17,7	18,0	18,5	18,9	19,2
Back waist length/	16,0	16,0	16,0	16,5	16,5	16,5	16,5	16,9

3D

3C

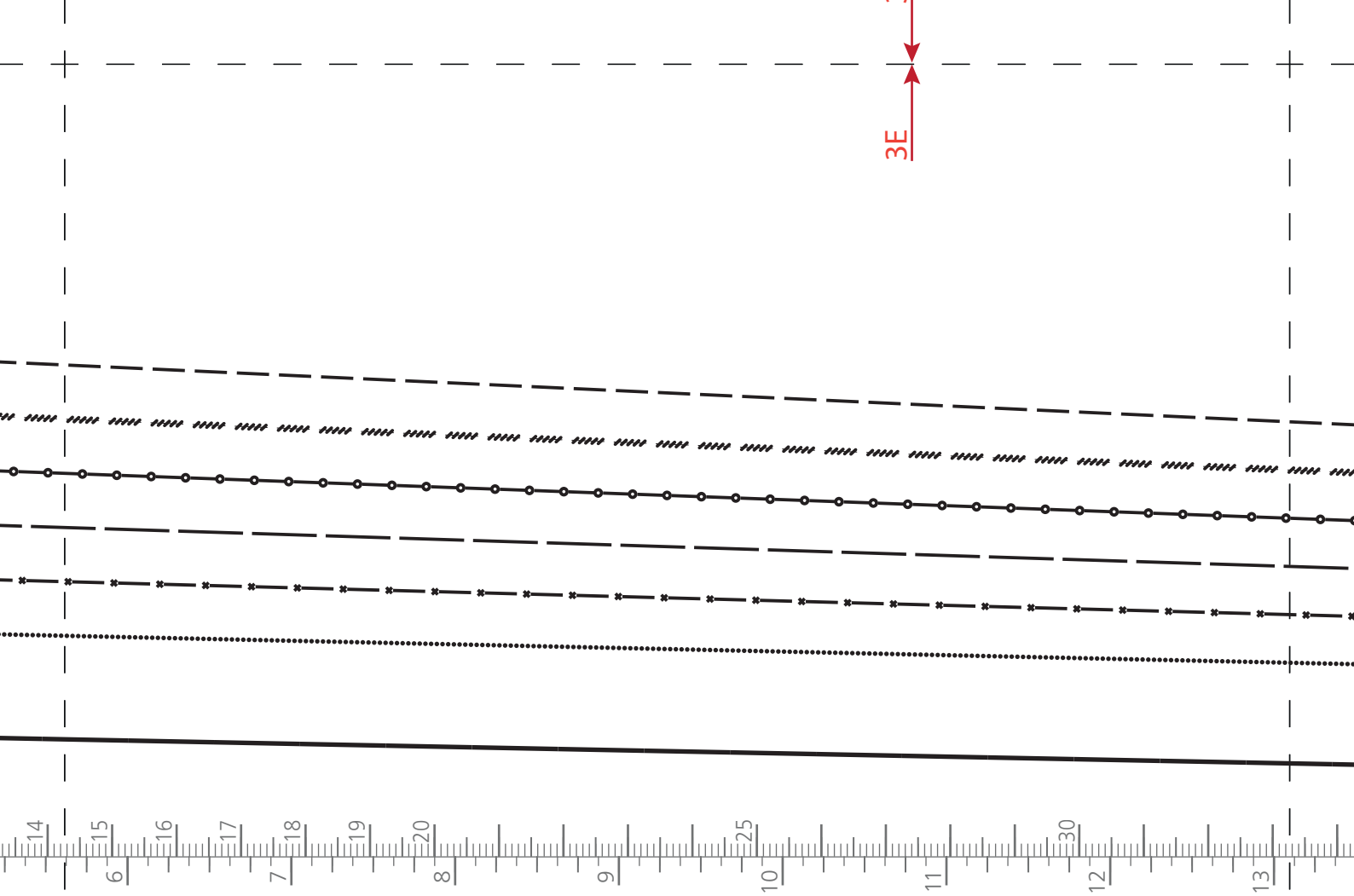

Wichtig: Alle Schnittteile sind ohne Nahtzugabe, falls nichts anderes vermerkt ist!

Important: All Patterns are without seam allowances, unless otherwise indicated !

Important: Toutes découpes sont sans surplus de couture (sauf mention contraire)!

Attentie: Alle patroondeelen zijn zonder naadtoeslag, tenzij anders vermeld

3E

3D

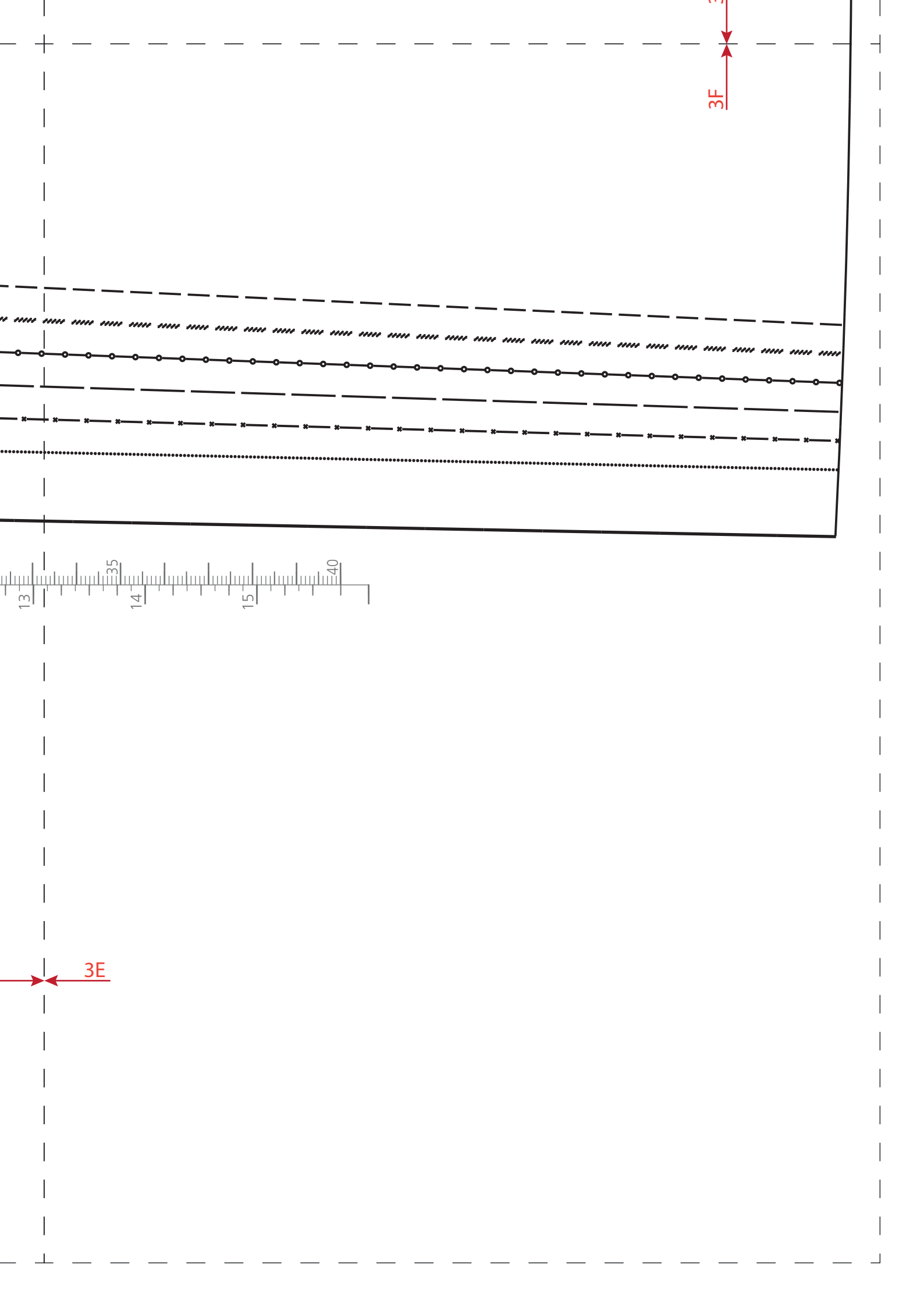

3

4A

4A

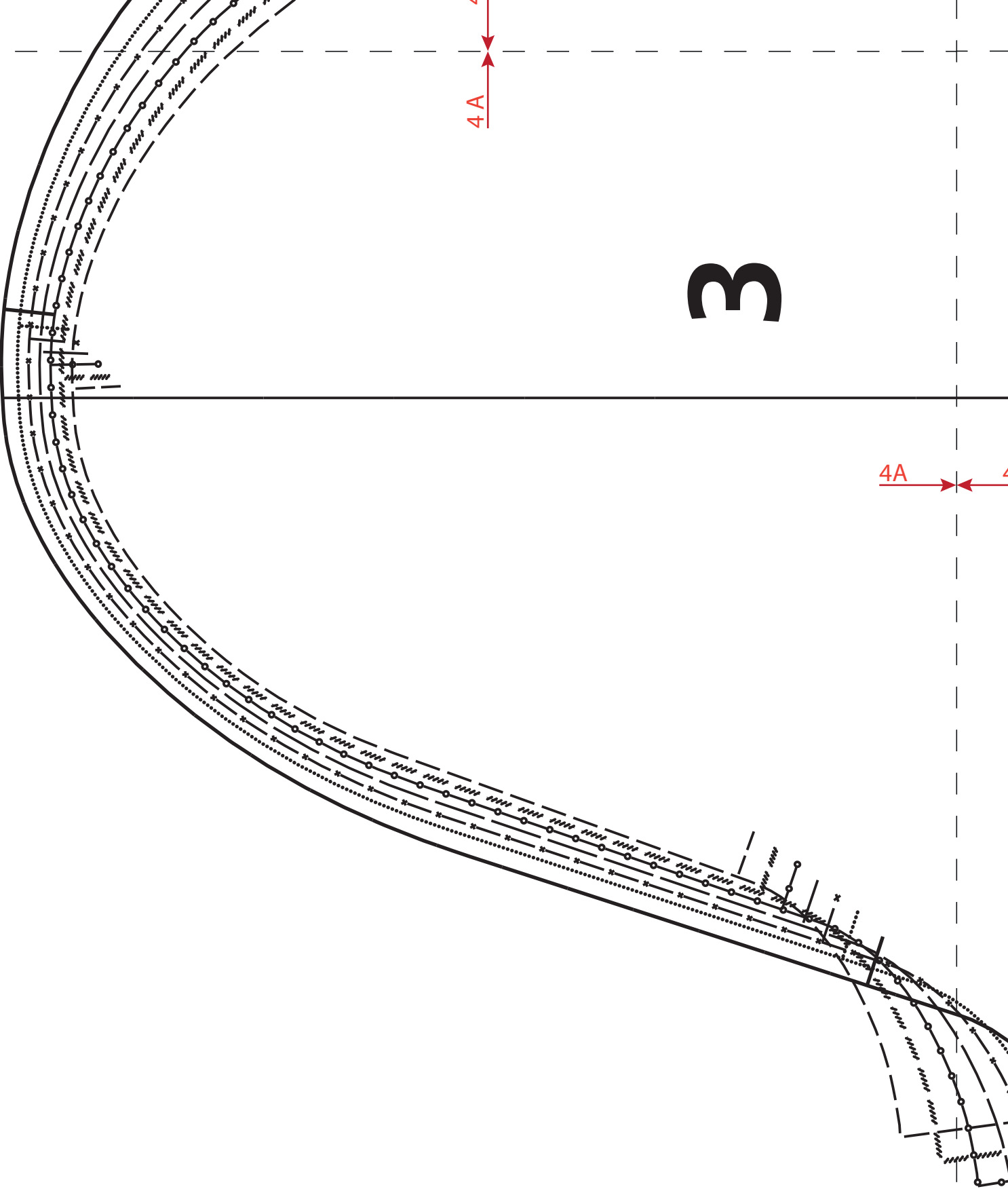

Fadenlauf/ Straight grain/ Droit fil/ Draadrichting

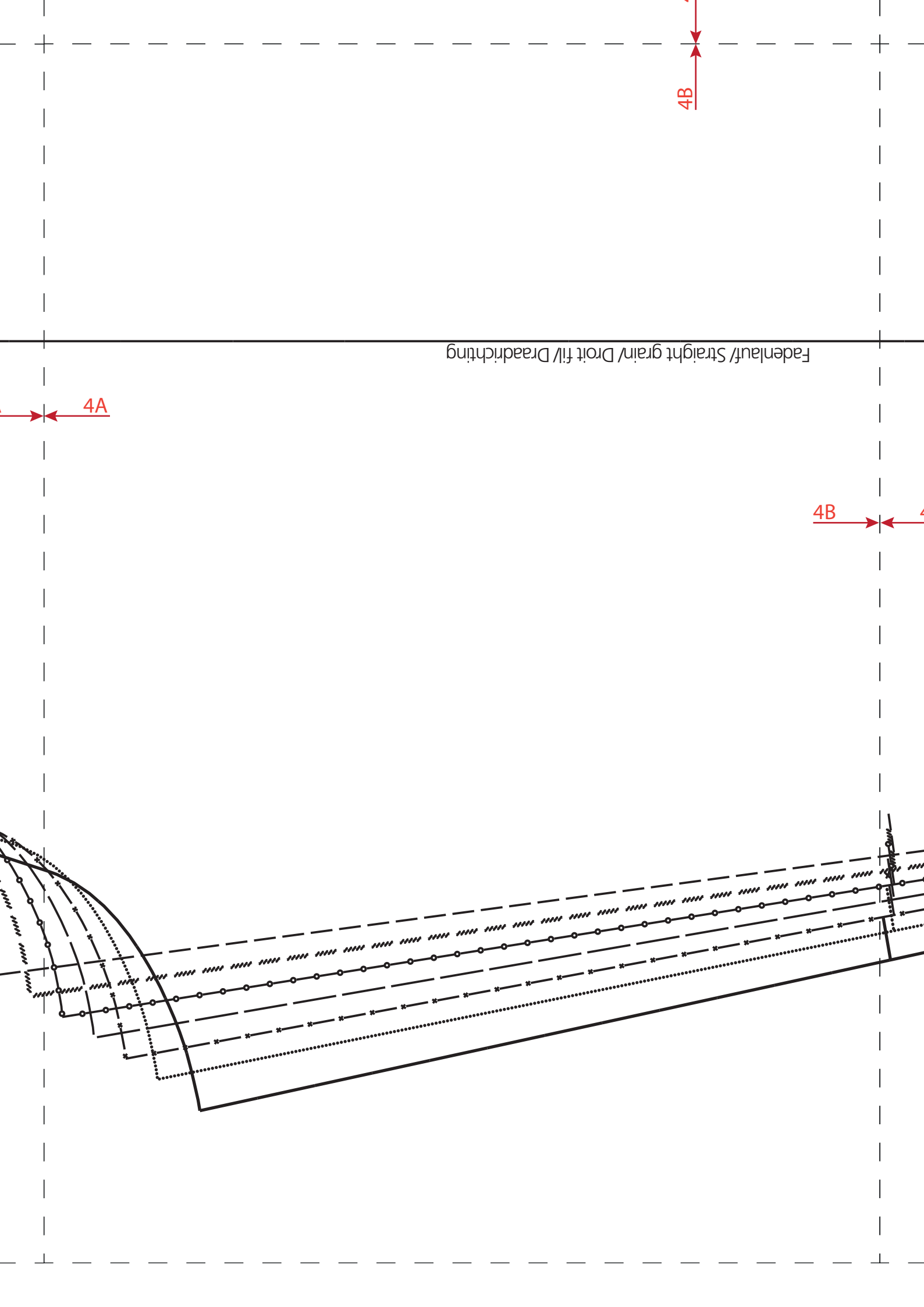

4B

4A

4B

