

IMPORTANT SAFETY INSTRUCTIONS !



When using an electrical appliance, basic safety precautions should always be followed, including the following:

Read all instructions before using this sewing computer. When the sewing computer is not in use, it should be disconnected from the electricity supply by removing the plug from the outlet.

DANGER

To reduce the risk of electrical shock:

1. An appliance should never be left unattended when plugged in.
2. Always unplug this sewing computer from the electrical outlet immediately after using and before cleaning.

WARNING

To reduce the risk of burns, fire, electric shock or injury to persons:

1. Do not allow to be used as a toy. Close attention is necessary when this sewing computer is used by or near children and infirm persons.
2. Use this sewing computer only for its intended use as described in this manual. Use only attachments recommended by the manufacturer as contained in this manual.
3. Never operate this sewing computer if:
 - it has a damaged cord or plug,
 - it is not working properly
 - it has been dropped or damaged,
 - it has fallen into water
 Return the sewing computer to the nearest authorized BERNINA dealer or service center for examination, repair, electrical or mechanical adjustment.
4. Never operate the sewing computer with any air vents blocked. Keep ventilation openings of the sewing computer and foot controller free from accumulation of lint, dust and fabric remnants and the like.
5. Keep fingers away from all moving parts. Special care is required around the sewing needle.

6. Always use the BERNINA original stitch plate. The wrong plate can cause needle breakage.
7. Do not use bent needles.
8. Do not pull or push fabric while stitching, which may deflect the needle, causing it to break.
9. Turn power switch to «0» (off) when making any adjustments in the needle area, such as threading or changing the needle, threading the bobbin or changing the presser foot etc.
10. Always unplug the sewing computer from the electrical outlet when removing covers, lubricating or when making any other user servicing adjustments mentioned in this instruction manual.
11. Never drop or insert any object into any openings on the sewing computer.
12. Do not use the sewing computer outdoors.
13. Do not operate where aerosol (spray) products are being used or where oxygen is being administered.
14. To disconnect, turn all controls to the off («0») position then remove the plug from the outlet.
15. Do not unplug by pulling on the cord, instead, grasp the plug before pulling.
16. No responsibility will be taken on behalf of **BERNINA** for any possible damage as the result of misuse of the sewing computer.
17. Under no circumstances should the sewing computer be left unattended when using the embroidery module.
18. This sewing computer is provided with double insulation (except USA / Canada). Use only identical replacement parts. See instructions for servicing of double-insulated machines.

SERVICING DOUBLE-INSULATED PRODUCTS

In a double-insulated product, two systems of insulation are provided instead of grounding. No grounding means is provided on a double-insulated product nor should a means for grounding be added to the product. Servicing a double-insulated product requires extreme care and knowledge of the system and should only be done by qualified service personnel. Replacement parts for a double-insulated product must be identical to those parts in the product. A double insulated product is marked with the words «DOUBLE INSULATION» or «DOUBLE INSULATED».

The symbol  may also be marked on the product.

This sewing and embroidery computer is intended for household use only.

SAVE THESE INSTRUCTIONS!

Dear artista Customer,

BERNINA continues the long-standing tradition of the famous artista family with the model range artista 630 and 640.

The name "artista" stands for something outstanding, artistic - an inspiring element.

With the new artista generation we would like to enable you to become an artist by giving you everything a sewing and embroidery system offers to allow your creativity to blossom and grow.

The modern design and high functionality of the artista 630 and 640 guarantee you sewing satisfaction, ease of use and frustration-free sewing enjoyment.

The artista 630 is the best sewing computer on the world market with outstanding stitch quality, but you also have the option of embroidery. The artista 640, with the Bernina rotary hook system, offers endless possibilities in embroidery. Bernina's exclusive embroidery rescaling gives you the freedom and control you need and deserve.

Both models have a beautiful color screen which is located in the center of the machine-right where you need it-and the user interface is extremely intuitive and easy to use.

For artista customers we recommend the optional BERNINA Embroidery Software, the Bernina Stitch Regulator (BSR) and the wonderful variety of accessories available at your local Bernina dealer.

We wish you lots of fun with our newest additions in the wonderful line of Bernina machines.



H.P. Ueltschi

H.P. Ueltschi
President
BERNINA Sewing Machine Manufacturers

BERNINA
CH-8266 Steckborn
www.bernina.com

BERNINA®

| | |
|--|------------------|
| Safety Instructions | 1 |
| Your Sewing Computer | 4 - 21 |
| Screen / Function Buttons | 22 - 33 |
| Applications of Practical and Decorative Stiches | 34 - 58 |
| Alphabets | 59 - 61 |
| Buttonholes | 62 - 76 |
| Quilting | 77 - 83 |
| Personal Program | 84 - 86 |
| Saving and Deleting Stiches and Stitch Combinations | 87 - 91 |
| Setup Program | 92 - 101 |
| Sewing and Sewing Computer Support | 102 - 108 |
| Preparing for Embroidery / Important Information | 109 - 119 |
| Working on Motifs and Embroidering | 120 - 145 |
| Embroidery Support | 146 - 151 |
| Peripherals and Accessories | 152 - 154 |
| Glossary | 155 - 156 |
| Summary Stiches and Motifs | 157 - 170 |
| Index | 171 - 173 |

Key to Signs

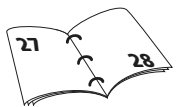

Additional information on the corresponding subject you will find on the relevant page.



Caution!
Very important!
Risk of damage!



Supplementary information!



Please refer to the safety instructions! Risk of injury!



Helpful tips!

Accessories*



Carrier Bag

- protects from dust and dirt
- this bag can be used to transport the sewing computer. The accessories can be stored in the corresponding compartments

Accessories

The following accessories are arranged in the styrofoam packing:

- foot control
- instruction manual
- power cable
- warranty card
- FHS presser foot lifter (Free Hand System)
- slide-on table
- seam guide for slide-on table
- Instructional / Presentation CD-ROM
- carrier bag
- Touch Screen Stylo

*can vary from country to country

Accessory Box

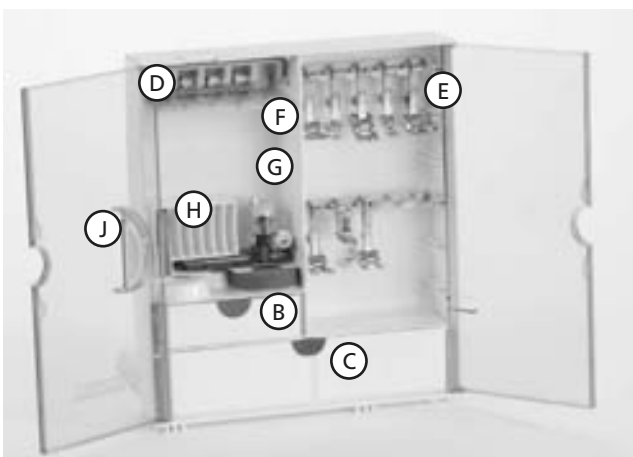

Free Standing Accessory Box

- on the back side of the box, pull both feet out until they click into place
- stand box in chosen position

Storing Accessories

Standard accessories are supplied in a plastic bag. The box is equipped with one small and one large drawer (B and C) as well as compartments for bobbin holders D and presser feet E. (Additional compartments and drawers are available as optional extras.)

- push the bobbins into the compartments provided
- to remove a bobbin, press the compartment holder F lightly
- insert the presser feet into the slot
- Buttonhole foot with slide No. 3A can be stored in the left compartment G
- the needle selection box can be stored in compartment H

Attaching the Accessory Box to the Sewing Computer

- close the doors
- push feet back into position
- attach the box to the sewing computer (catch A must engage); inserting the presser foot lifter into the opening J



Removing the Accessory Box

- press catch A on the top of the box
- remove box to the rear



Caution:
First lower the presser foot lifter!

Presser Feet*



1
Reverse pattern foot
Practical and decorative stitches



2
Overlock foot
Overlock seams, hems, clean finishing edges, narrow satin stitch



3
Buttonhole foot
Buttonholes



3A
Automatic Buttonhole foot with slide
Buttonholes on smooth fabrics, darning



4
Zipper foot
Sewing in zippers



5
Blindstitch foot
Blind hems, edge stitching



9
Darning foot
Used with the feed dog in a lowered position for darning, monograms, and freehand embroidery



20
Open embroidery foot
Embroidery, appliqué, satin stitch seams, monograms

BERNINA Specialty Presser Feet

The standard selection of presser feet covers most normal sewing requirements, but we recommend the use of BERNINA specialty presser feet for specific sewing tasks such as quilting, heirloom sewing, home decorating, tailoring, etc. They are available from your BERNINA dealer.



8
Jeans foot
Straight stitching in thick, firm fabrics



50
Walking foot
For fabrics which stick or tend to slip and for quilting



Standard Accessories*

- four bobbins (+ one in bobbin case)
- selection of 130/705 H needles
- seam ripper
- small screwdriver
- angular Torx key
- lint brush
- seam guide
- foam pad

- height compensating tool
- three spool discs
- oiler
- compensation plate for sewing buttonholes

*can vary from country to country

Details artista 630

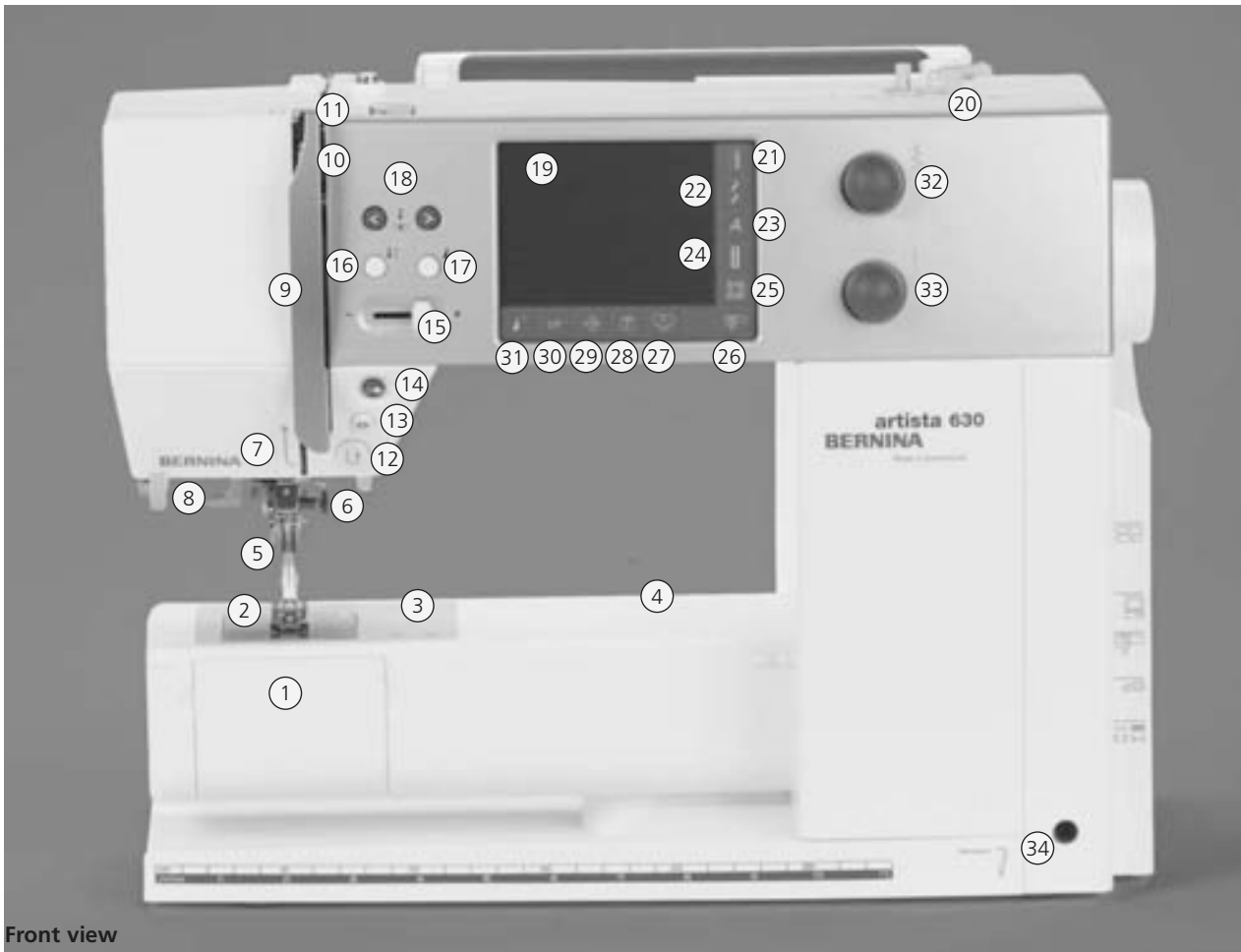

Front view



Back view



Side view left

- 1 Bobbin cover
- 2 Stitch plate
- 3 Attachment base for special accessories
- 4 Darning hoop connection
- 5 Presser foot
- 6 Needle clamp
- 7 Thread guide
- 8 Needle threader
- 9 Thread take-up cover
- 10 Thread path
- 11 Thread take-up
- 12 Quick reverse button
- 13 Securing function button
- 14 Start / Stop - button

- 15 Slide speed control
- 16 Needle stop up/down button
- 17 Pattern end button
- 18 Needle position buttons
- 19 Screen
- 20 Bobbin winder with on/off switch and thread cutter
- 21 Practical stitch button
- 22 Decorative stitch button
- 23 Alphabet button
- 24 Buttonhole button
- 25 Quilt stitches button
- 26 Sewing mode/Embroidery mode button
- 27 Personal program button

- 28 Tutorial button (only in embroidery mode)
- 29 Setup button
- 30 «clr» (clear) button
- 31 Pattern begin button
- 32 Stitch width knob
- 33 Stitch length knob
- 34 FHS (Free Hand System) connection
- 35 Thread guide (while winding the bobbin when sewing and embroidering)
- 36 Horizontal spool pin
- 37 Carrying handle
- 38 Rear thread guide
- 39 CFL (Cool Fluorescent Light) sewing light
- 40 Slide-on table socket
- 41 Bobbin pre-tension

- 42 Tension adjustment wheel
- 43 Presser foot pressure dial
- 44 Presser foot lifter
- 45 Thread cutter on head frame
- 46 Magnifying glass holder
- 47 Handwheel
- 48 Spool pin (vertical, collapsible)
- 49 Power switch on/off («0»)
- 50 Power plug socket
- 51 USB connection
- 52 PC connection
- 53 Embroidery module connection
- 54 Foot control socket
- 55 Drop feed dog



Side view right

Power Cable

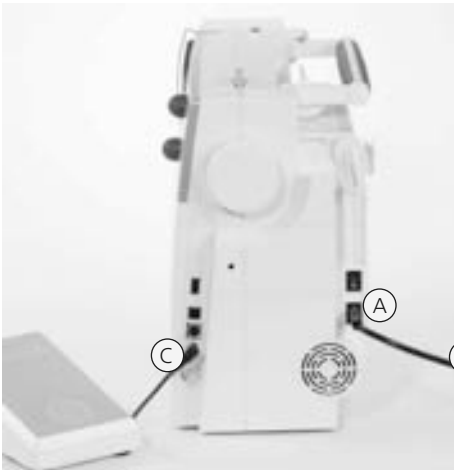

The Power Cable

- plug **A** into sewing computer
- plug **B** into wall socket

Foot Control Cable

- plug **C** into sewing computer



Important!
(USA/Canada only):
 The sewing computer has a polarized plug (one blade wider than the other). To reduce the risk of electrical shock, this plug is intended to fit in a polarized outlet only one way. If the plug does not fit fully in the outlet, reverse the plug. If it still does not fit, contact a qualified electrician to install the proper outlet. Do not modify the plug in any way!

Foot Control



Sewing Speed

- control the sewing speed by depressing the foot control
- raise or lower the needle by tapping on the foot control with your heel

Cable Tidy

- wind the cable around the spool
- insert the plug into **A**

When Sewing

- unwind the cable to the desired length and slip into **B** or **C**



Important!
(USA/Canada only):
 Use only foot controller type LV1 with sewing computer model artista 630.

Power Switch



The switch is on the handwheel side of the sewing computer

- I** the sewing computer is switched on («I»)
- 0** the sewing computer is switched off («0»)

The sewing light is switched on and off with the power switch.



Refer to the safety instructions!

Slide-on Table



Slide-on Table

- the slide-on table increases the sewing surface
- free arm for large tubular items such as pant legs and waistbands

To Attach

- raise the needle and presser foot
- place the table to the right over the free arm and press firmly so that it engages on the fixing cam

To Remove

- raise needle and presser foot
- pull the table out of the fixing cam
- remove to the left



Seam Guide

- insert into the groove (underside of table) from left or right
- it can be adjusted over the whole width of the table

Scale

- «0» corresponds to the center needle position

Free Hand System (FHS) Presser Foot Lifter



Presser Foot Lifter

- the FHS raises and lowers the presser foot
- push to the right
- the presser foot is raised
- the feed dog is lowered simultaneously
- the feed dog is raised as soon as the first stitch is sewn

Attaching the Presser Foot Lifter

- insert into the opening; you should be able to operate the FHS with your knee in your normal sitting position



Your dealer can adjust the FHS if necessary.

Winding the Bobbin

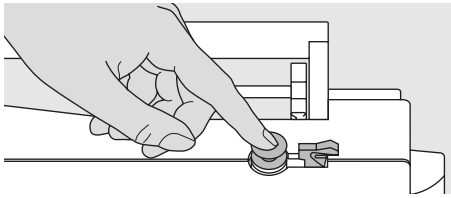

Winding the Bobbin

- turn power switch to «I» (on)
- place empty bobbin on spindle

- the winding speed can be adjusted with the «+» or «-» in the opened screen or by turning the stitch width knob
- the motor will stop automatically when the bobbin is full
- remove the bobbin

Threading the Bobbin

- place thread on spool pin
- attach appropriate spool disc - diameter of thread spool determines disc size
- following the direction of the arrow, take thread through the rear guide and around the pre-tension stud
- wind the thread two to three times around the empty bobbin and cut off any excess thread on the thread cutter
- press the engaging lever against the bobbin
- the bobbin winder works automatically

Thread Cutter

- cut the thread with the thread cutter

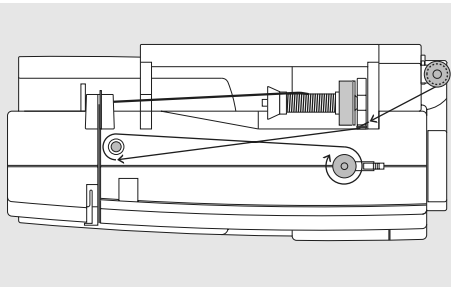
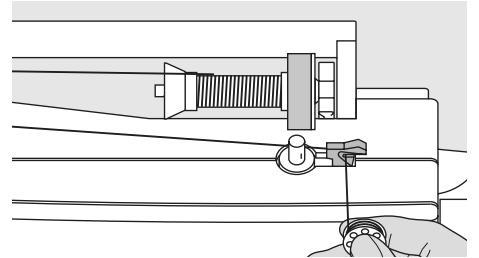
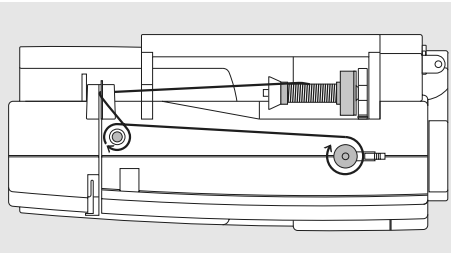

Winding the Bobbin While Sewing or Embroidering

- place thread spool on vertical spool then, following the direction of the arrow, take thread through the thread guide and around the pre-tension stud
- follow the instructions as described above for the next steps of winding the bobbin

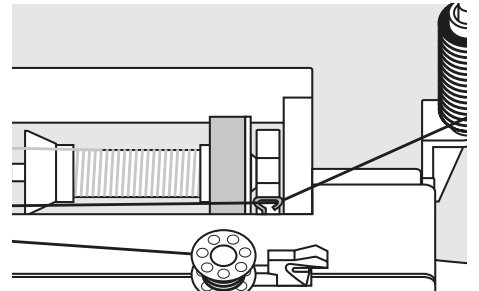

Bobbin Case

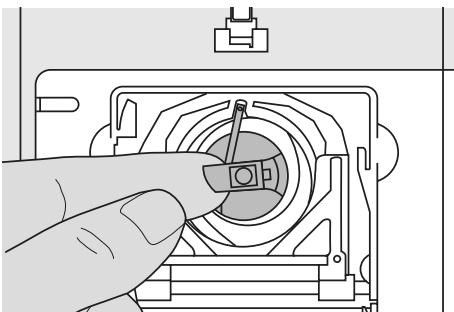

To Remove the Bobbin Case

- raise the needle
- turn power switch to «0» (off)
- open the bobbin cover
- grasp the latch of the bobbin case
- remove case

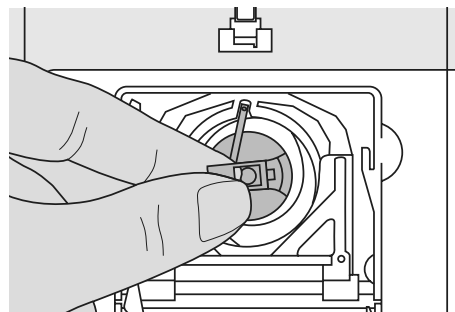

To Insert the Bobbin Case

- hold the bobbin case latch
- the finger on the case should point upwards
- insert so that it clicks into place
- close the bobbin cover

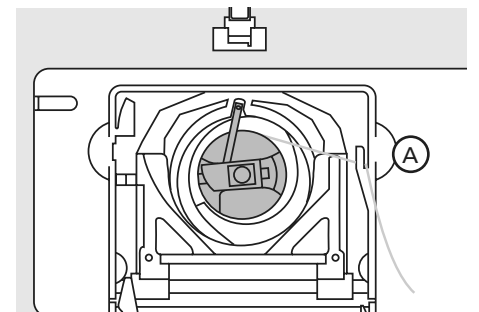

Bobbin Thread Cutter

- insert the bobbin case
- take the thread over cutter **A** and cut the thread

! Refer to the safety instructions!

i The bobbin thread does not have to be brought up as the loose end is just the right length to start sewing.

Inserting the Bobbin

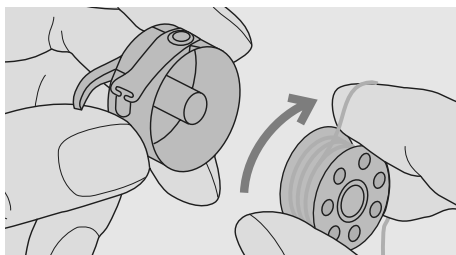

Inserting the Bobbin

Insert the bobbin so that the thread winds clockwise.

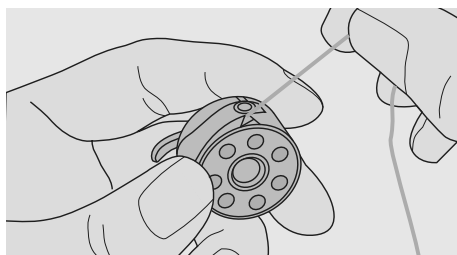

Pulling the Thread Under the Spring

Pull the thread to the left under the spring until it lies in the T-shaped slit at the end of the spring.

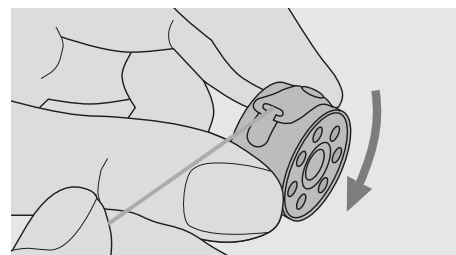

Clockwise Turning of the Bobbin

The bobbin must turn clockwise.

Threading the Upper Thread

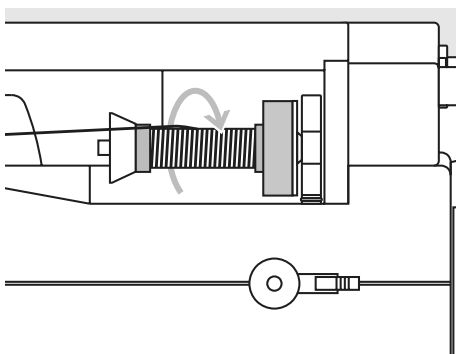
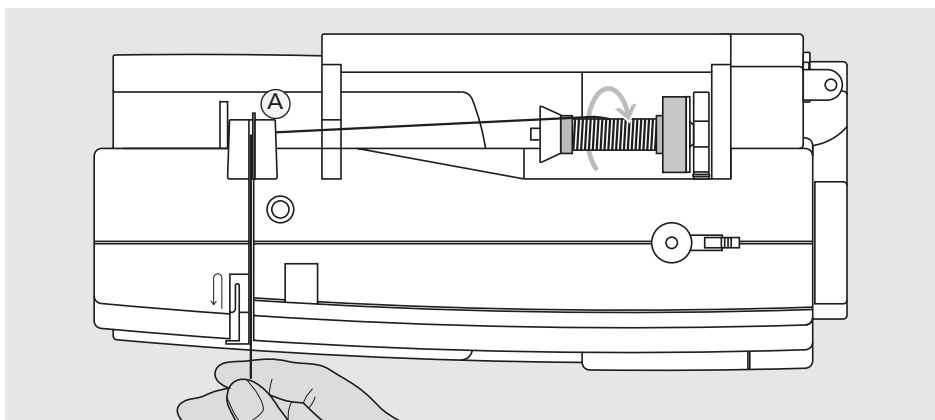

Attaching the Thread Spool

- raise the needle and presser foot
- turn the power switch to «0» (off)
- attach the foam pad
- place spool on pin (thread winds clockwise)
- attach the appropriate spool disc - diameter of spool determines disc size. There must be no clearance between the disc and the spool
- take thread through rear guide **A**
- then into slit of upper thread tension

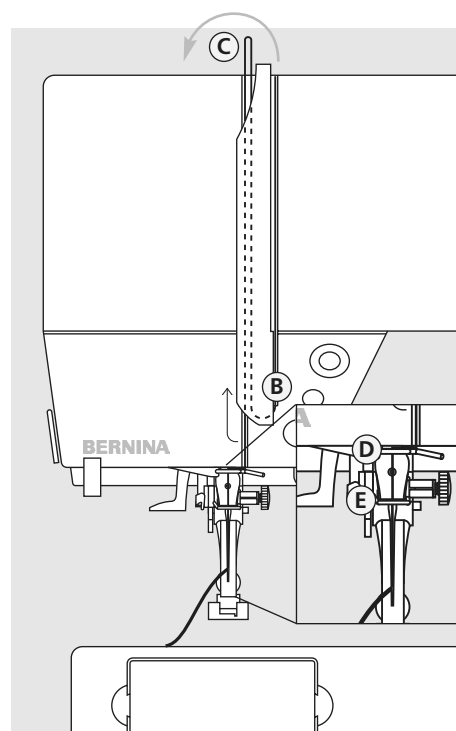
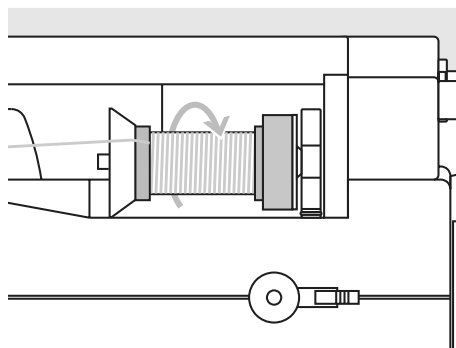

Down

- pull thread down to the right of the take-up cover to **B**

Up

- take thread up to the left of the cover to **C** in the direction of the arrow, placing it in the take-up lever

Down

- take thread down and through guides **D** and **E**

! Refer to the safety instructions!

Needle Threader

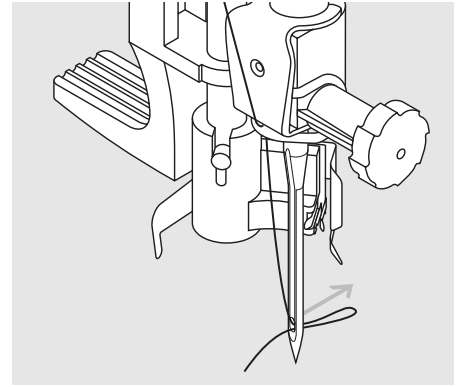
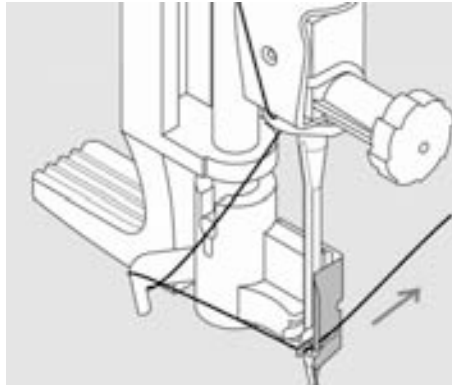
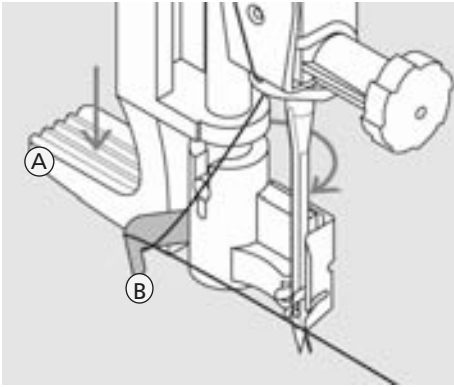

Lever Down and Thread in Hook

- raise the needle
- lower the presser foot
- press lever **A** down and simultaneously guide the thread around hook **B** to the right of the needle

Thread in Front of Needle

- put the thread from the front into the guide until it catches in the hook

Release the Lever and Thread

- let go of lever **A** and thread
- pull the thread loop through the needle eye



Special needles such as double and triple needles must be threaded by hand

Bringing up the Lower Thread

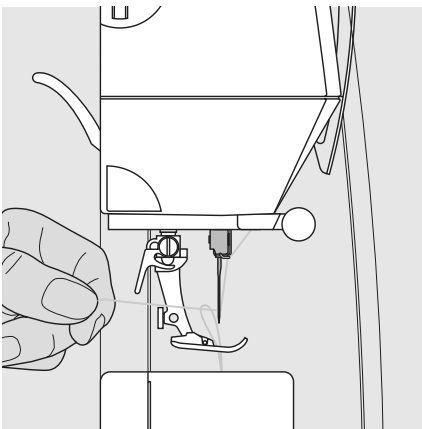

- hold the upper thread
- sew one stitch by tapping on the foot control twice
- pull the upper thread to bring the lower thread up through the stitch plate hole
- take both threads through the slit on the presser foot to the back
- pull threads over the head frame cutter



The bobbin thread must be brought up through the stitch plate for certain types of work. The length of thread is sufficient for most normal work if the lower thread cutter has been used.

Thread Cutter

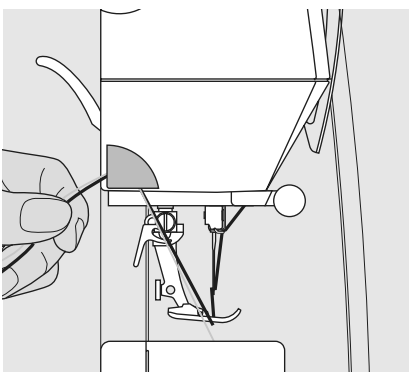

Thread Cutter on Head Frame

- pull both threads from front to back over the cutter
- the threads release automatically as soon as the first stitch is sewn

Changing the Needle

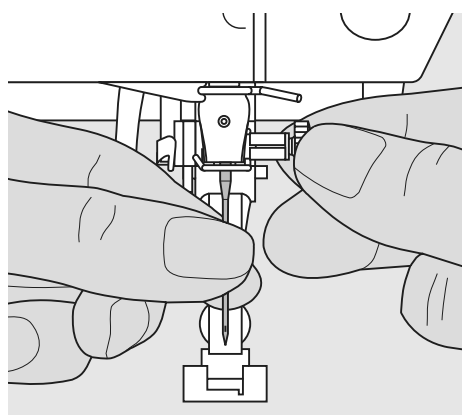

Removing the Needle

- raise the needle
- turn power switch to «0» (off)
- lower the presser foot
- loosen the needle clamp screw
- pull the needle down to remove

Inserting the Needle

- flat side of needle to the back
- insert the needle as far as it will go
- tighten the needle clamp screw



Refer to the safety instructions!

Supplementary Spool Pin

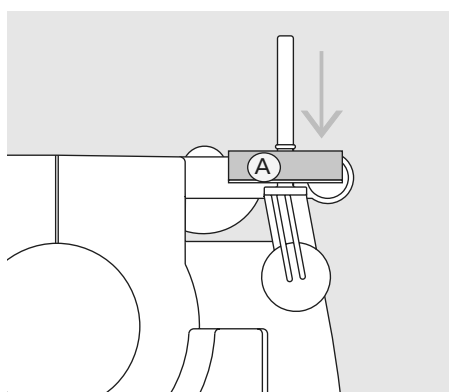
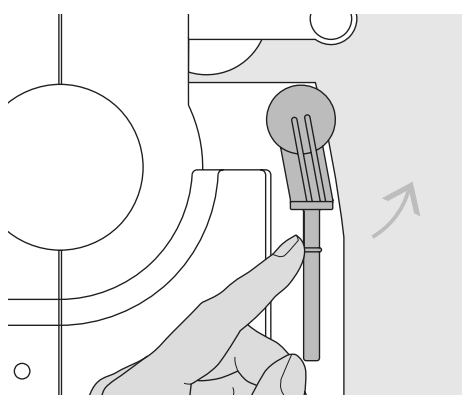

Collapsible Vertical Spool Pin

- found on the back of the sewing computer behind the handwheel
- essential aid for sewing with more than one thread, i.e. double needle work
- raise the pin until it clicks into its vertical position
- add the foam pad **A** for stability, this prevents the thread from getting caught on the spool pin

Threading the Double Needle

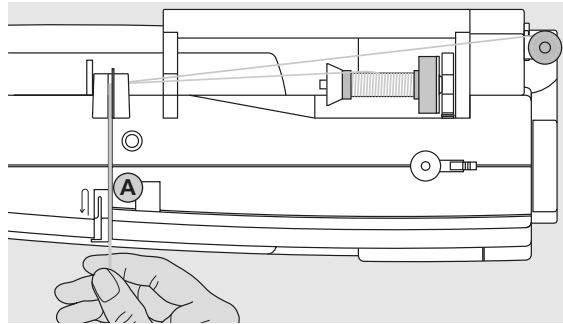

Threading the First Thread

- place thread spool on horizontal spool pin and thread
- guide the thread to the front in the slit and past the tension disc **A** on the right side
- thread sewing computer as usual and thread the right needle

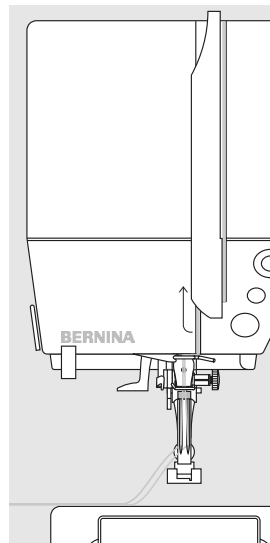

Threading the Second Thread

- place thread spool on the additional spool pin and thread
- guide the thread to the front in the slit and past the tension disc **A** on the left side
- thread the left needle
- threads must not be twisted together



When using the supplementary spool pin (vertical) always attach the foam pad (prevents the thread from getting caught on the spool pin)

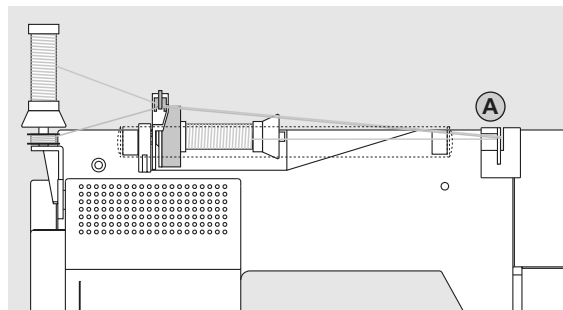

Threading the Triple Needle

- two thread spools and one full bobbin are needed
- place one thread spool on horizontal spool pin
- place second thread spool and the bobbin, separated by a spool disc, on additional spool pin (both spools have to turn in the same direction)
- thread as usual by guiding two threads on the left side of the tension disc **A** and one thread on the right side of the disc



By using the Supplementary thread guide (special accessories), thread winds off the spool much easier.

Upper Thread Tension

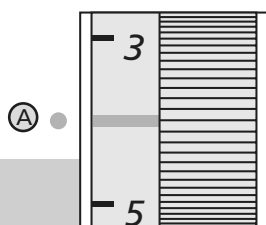

For example:

| | Tension | Needle |
|------------------------|-------------|--------|
| Metallic thread | approx. 3 | 90 |
| Mono-filament | approx. 2-4 | 80 |

The Basic Setting

- is indicated when the red line on the tension adjustment wheel is in line with the marking **A**
- the tension does not need adjusting for normal sewing work
- for special sewing work, the tension can be adjusted to suit the fabric

The tension is factory set for the best results with Metrosene 100/2 threads (Arova Mettler, Switzerland).

If other threads are used, the tension may need adjusting to suit the fabric and chosen stitch.



Thread Tension Settings

Perfect Stitch Formation

- the stitch formation is in the fabric



Upper Thread Tension too Tight

- the lower thread is pulled more to the right side of the fabric
- to reduce the upper thread tension turn tension adjustment wheel to 3 - 1



Upper Thread Tension too Loose

- the upper thread is pulled more to the wrong side of the fabric
- to increase the upper thread tension turn tension adjustment wheel to 5 - 10

CFL Sewing Light (CFL = Cool Fluorescent Light)



Contrary to an ordinary bulb, the CFL sewing light has a better illumination and a longer life.



Caution:
Please note that a defective CFL sewing light must **ONLY** be replaced by an authorized technician. The sewing computer must be brought to an authorized **BERNINA** dealer!

Important Facts About Thread and Needles

With the right combination of thread and needle optimum sewing results are achieved.

Thread

The thread is chosen according to use. For a perfect sewing result, thread and fabric quality play an important role. It is recommended to use quality brands.

Cotton Thread

- cotton thread has the advantage of a natural fiber and therefore is especially suitable for sewing cotton fabrics
- if cotton thread is mercerized it will have a slight sheen

Polyester Thread

- polyester thread is suitable for practically all sewing needs
- it has a high tensile strength and is particularly colorfast
- polyester thread is more flexible and is recommended where a strong and elastic seam is required

Needle, Thread and Fabric

Care must be taken when choosing needle and thread.

The correct needle size does not only depend on the chosen thread, but also has to be well-suited to the fabric used. The fabric weight determines the thread weight and needle size and point form.

| The following are the guidelines: | Needle No. |
|---|---------------|
| fine fabrics: fine thread (darning thread, embroidery thread) | 70–75 |
| mediumweight fabrics: normal thread | 80–90 |
| heavyweight fabrics: heavier thread | 100, 110, 120 |

Needle/Thread Combination

In order to check the needle/thread compatibility, the correct size thread must correspond with the correct size needle.

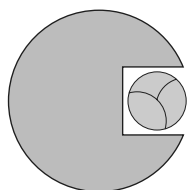

Correct Needle/Thread Combination

When sewing, the thread should travel smoothly down the long groove on the front of the needle.

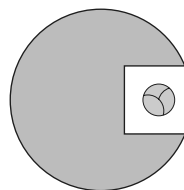

Too Thin Thread or too Thick Needle

The thread has too much clearance in the groove. Skipped stitches and damage to the thread can occur.

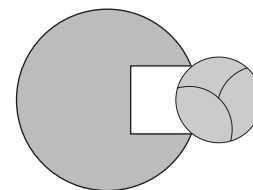

Too Thick Thread or too Fine Needle

The thread rubs on the edges of the groove and can get jammed. This can break the thread.

Needle Summary

BERNINA requires needle system 130/705 H. This system number refers to shank shape as well as to length and form of the needle point.

Checking the Needle Condition

The needle condition should be checked and the needle replaced regularly. A defective needle not only damages the fabric but also the sewing computer.

The following are the guidelines: replace needle when starting a new sewing project or as required.

130/705 H S 70

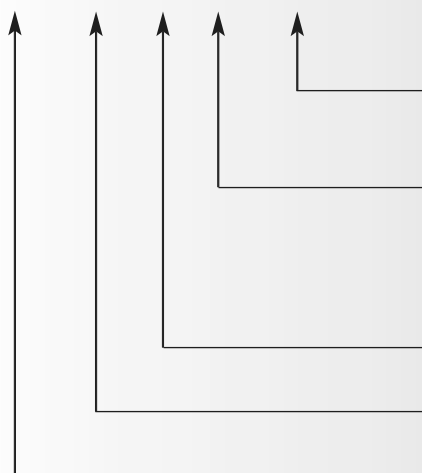

Shank diameter = 0.7 mm (needle size)

Needle point e.g. medium ball point

Needle scarf





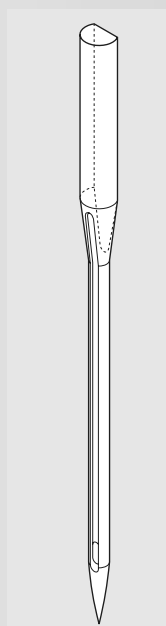





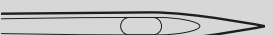

Flat shank

Shank length



Needle Summary

Many materials are easier to sew if the appropriate needle is used.

| Type of needle | Model | Suitable for | Needle size |
|--|---|--|-------------|
| Universal 130/705 H |  Normal point, slightly rounded | For nearly all natural and synthetic fabrics (woven and knitted) | 60–100 |
| Jersey/Stretch 130/705 H-S 130/705 H-SES 130/705 H-SUK |  Ball point | Jersey, stretch fabrics | 70–90 |
| Leather 130/705 H-LL 130/705 H-LR |  Cutting point | Natural and synthetic leather and plastic | 90–100 |
| Jeans 130/705 H-J |  Very fine point | Heavyweight fabrics such as denim, canvas, overalls | 80–110 |
| Microtex 130/705 H-M |  Especially fine point | Micro fiber fabrics and silk | 60–90 |
| Quilting 130/705 H-Q |  Fine point | Straight and topstitching | 75–90 |
| Embroidery 130/705 H-E |  Large eye, slight ball point | Embroidery on all natural and synthetic fabrics | 75–90 |
| Metafil 130/705 H-MET |  Large eye | Sewing with metallic threads | 75–90 |
| Cordonnet 130/705 H-N |  Small ball point, long eye | Topstitching with thick thread | 80–100 |
| Wing needle 130/705 HO |  Wide needle (wing) | Hemstitching | 100–120 |
| Double wing needle 130/705 H-ZWI-HO |  | Special effects with hemstitch embroidery | 100 |
| Double needle 130/705 H-ZWI |  Needle distance: 1.0 / 1.6 / 2.0 / 2.5 / 3.0 / 4.0 | Visible hems in stretch fabrics, pintucks, decorative sewing | 70–100 |
| Triple needle 130/705 H-DRI |  Needle distance 3.0 | Decorative sewing | 80 |

Special needles are available at your **BERNINA** dealer.

Presser Foot Pressure

Dial on Head Frame

- the pressure is adjusted at the left side of the head frame
- the original setting (47) will be indicated on the screen in blue
- an adjusted presser foot pressure will be indicated by a red blinking number and a red bar
- the original setting (47) will be indicated in black alternately with the adjusted setting
- the original setting is displayed by a blinking black line on the right side of the red bar

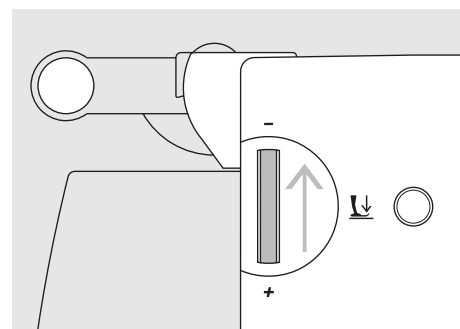
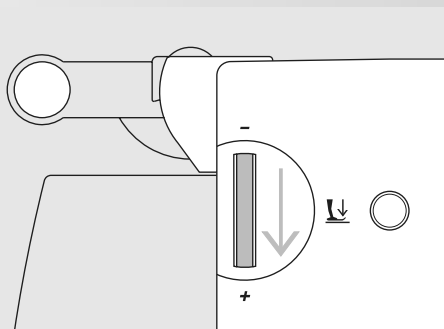

Standard Pressure

- for normal sewing work

Increased Pressure

- for firm fabrics
- improves fabric feed

Reduced Pressure

- for jerseys and loose knits
- to prevent fabric from stretching
- adjust pressure so that the fabric still feeds correctly



Changing the Presser Foot

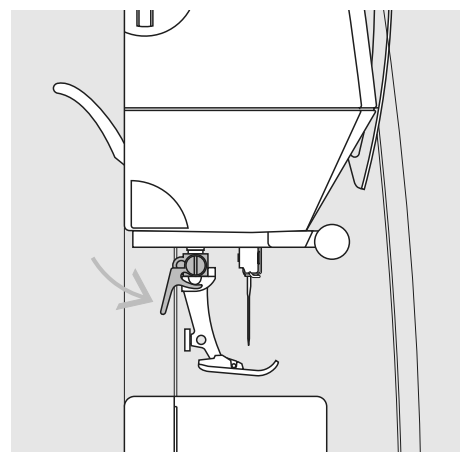
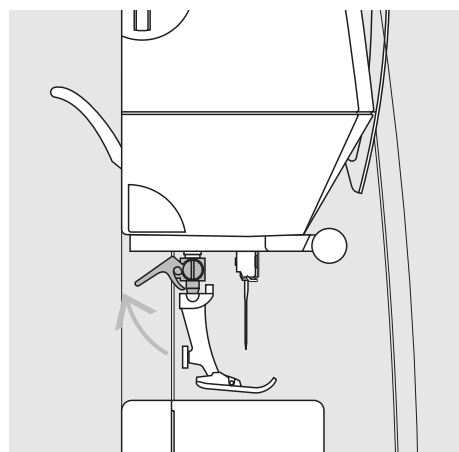
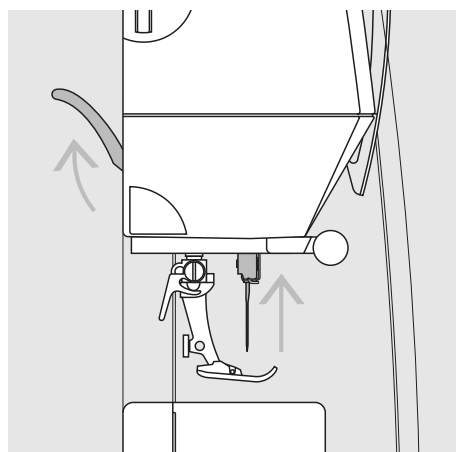

Changing the Presser Foot

- raise the needle and presser foot
- turn power switch to «0» (off)

Raising the Lever

- raise the clamping lever
- remove the presser foot

Attaching the Presser Foot

- guide the foot upwards over the cone
- press the clamping lever down

! Refer to the safety instructions!

Stitch Plate

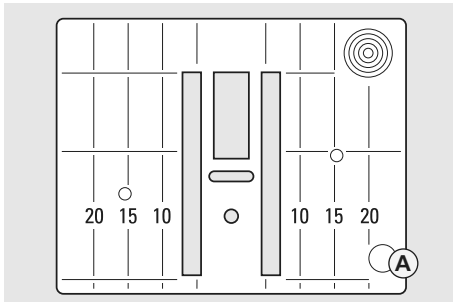

5.5mm (mm measurements)

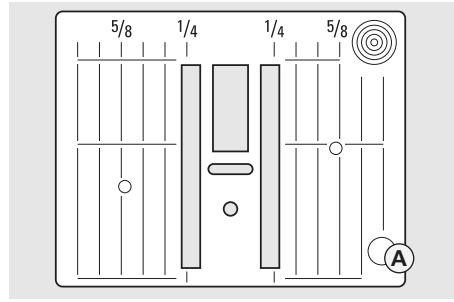

5.5mm (inch measurements)

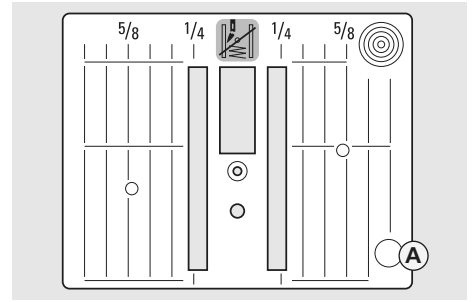

Straight Stitch Plate
(optional accessory)

Stitch Plate Markings

- the stitch plates are marked with vertical lines in millimeters or inches
- mm measurements are at the front
- inch measurements are at the back
- the measurements correspond to the distance from the needle to the line

- needle insertion point is position 0 (center needle position)
- the measurements are marked to the right and left
- the lines help to guide the fabric e.g. for sewing seams and for topstitching
- the horizontal markings are helpful for sewing corners and buttonholes, etc.

Removing the Stitch Plate

- turn power switch off («0»)
- raise the presser foot and needle
- lower feed dog
- press the stitch plate down at the back right corner until it flips up
- remove the stitch plate

Replacing the Stitch Plate

- place the stitch plate over the opening A and press down until it clicks into place

Feed Dog

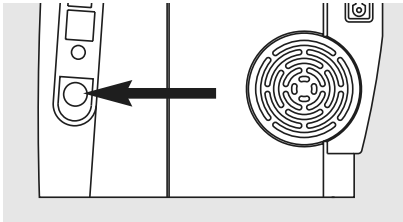

Button on handwheel side



Button flush with housing = feed dog is raised (sewing position)



Button depressed = feed dog is lowered (darning position)

- for freehand sewing (darning, freehand embroidery, freehand quilting)
- for embroidery with the embroidery module

Feed Dog and Fabric Feed

Feed Dog and Stitch Length

With each stitch the feed dog moves forward by one step. The length of this step is determined by the stitch length selected.

With an extremely short stitch length, the steps are also very short. The fabric moves under the foot quite slowly, even at full

sewing speed. Buttonholes, satin stitch and decorative stitches are all sewn with a very short stitch length.



Let the fabric feed evenly!



Pulling, pushing or holding back the fabric will result in uneven stitches



Feed Dog and Fabric Feed with Height Compensating Tool

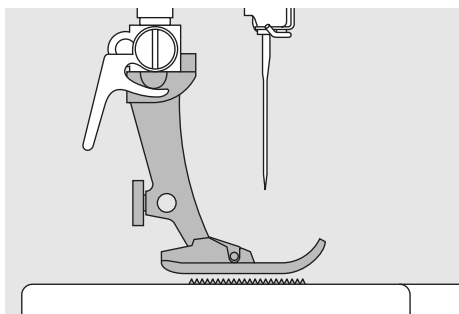

The feed dog works accurately when the foot is level.

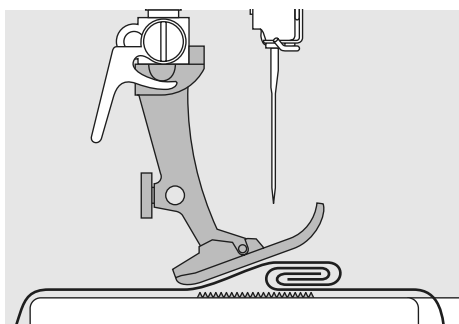

If the foot is at an angle, e.g. when sewing over thick to thin or vice-versa, the feed dog cannot grip and feed the fabric and the fabric might jam.

Uneven layers

To solve this problem, place one, two or three compensating plates as required behind the needle under the presser foot to level it.

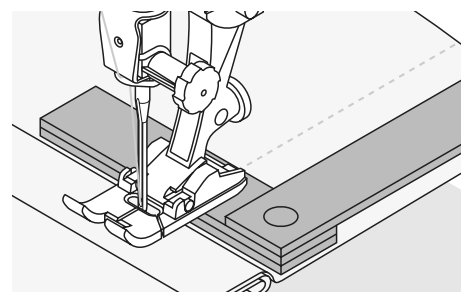

To correct the height in front of the foot, place one or more plates to the right of the foot close to the needle. Sew until the foot is level again and remove the plates.

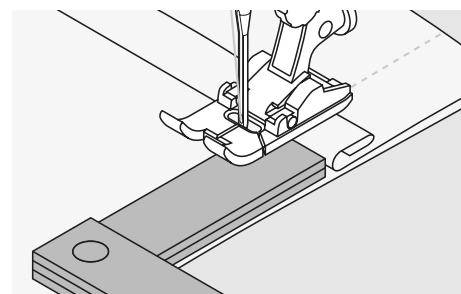

Feed Dog and Sewing Corners

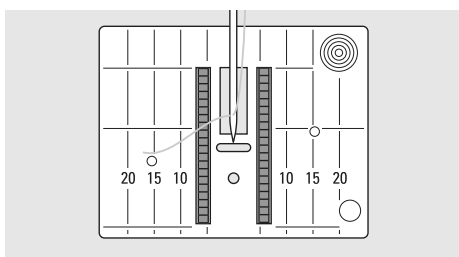

The space between the two rows of feed dogs is relatively large due to the width of the stitch plate hole.

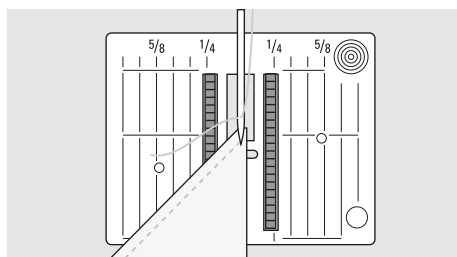

When sewing corners only a small section of the fabric is actually on the feed dog, so that it cannot grip the fabric well.

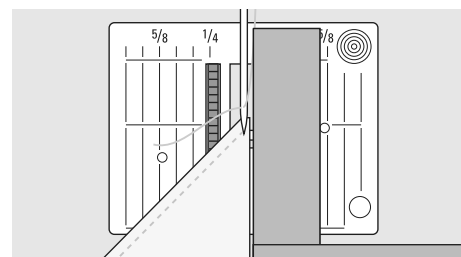

Correct this by placing one or more compensating plates as close as possible to the edge of the fabric.

Screen

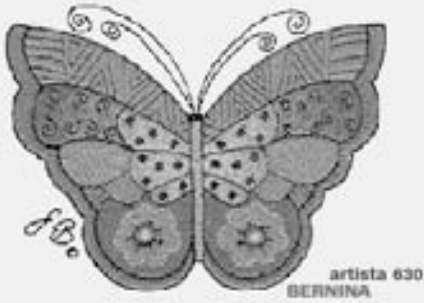

The artista 630 is operated with a combination of external buttons and knobs and a touch screen.

Welcome Screen

- switch sewing computer on: power switch to «I» (on)
- Welcome screen appears for a few seconds, as long as text was entered in the Setup Program. Without text the Practical Stitch screen appears directly
- the start of the Welcome screen can be canceled by touching the screen and the Practical Stitch Screen appears
- can be personalized in the Setup Program

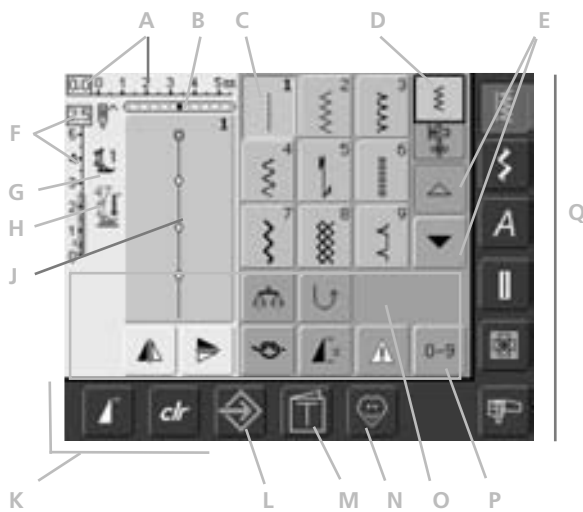

Practical Stitch Screen

After the Welcome, the Practical Stitch (Menu) appears automatically on the screen, which shows:

- A Stitch width (basic setting always visible)
- B Needle Position (11 possibilities)
- C Selected, active stitch and number
- D Single Mode / Combi Mode
- E Up/down scroll arrows
- F Stitch length (basic setting always visible)
- G Presser Foot Indicator
- H Presser Foot Pressure Indicator
- J Picture of selected, active stitch and number (Stitch Altering Area)
- K External functions
- L Setup Program
- M Tutorial (only for embroidery)
- N Personal Program
- O Functions
- P Stitch Selection by Number
- Q Main category buttons

Stitch Selection – Stitch Display – Functions

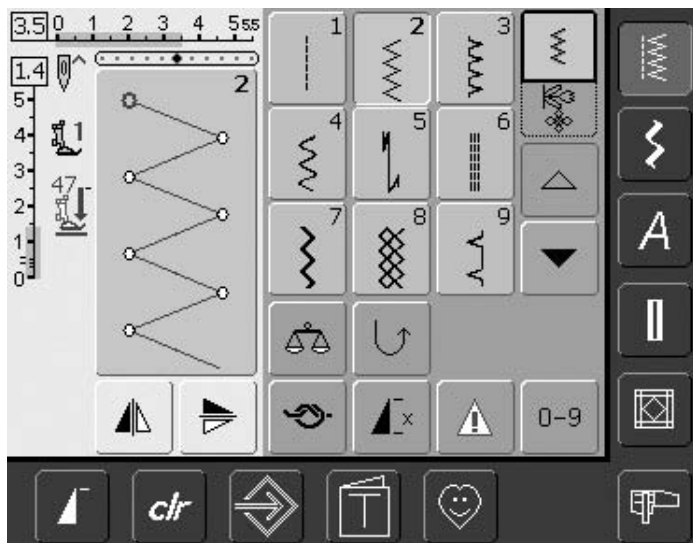

Stitch Selection

- touch the stitch of your choice
- the stitch is highlighted in blue
- every stitch in the Stitch Altering Area (SAA) is displayed with its number



Display of Selected Stitch

- a graphic of the selected stitch is visible in the left portion of the screen
- changes to stitches can be seen on screen



Altering the Stitch Width

- turn the upper knob



The altered stitch width is shown in two different ways:

- stitch width bar 0-5.5 is displayed as blue area
- altered width is visible on stitch width bar (dark blue bar), in addition the actual setting is shown (blue number left)
- the basic setting is always visible when a change has been made, e.g. 3.0mm (black bar)
- the stitch width can be altered from 0mm to 5.5mm



Altering the Stitch Length

- turn the lower knob



The altered stitch length is shown in two different ways:

- stitch length bar 0-5 is displayed as blue area
- altered length is visible on stitch length bar (dark blue bar), in addition the actual setting is shown (blue number on top)
- the basic setting is always visible when a change has been made, e.g. 1.5mm (black bar)
- stitch length can be altered from 0mm to 5mm on most stitches



Presser Foot Indicator

- the recommended presser foot for the selected stitch is displayed by number
- an arrow pointing down indicates that the presser foot is still raised

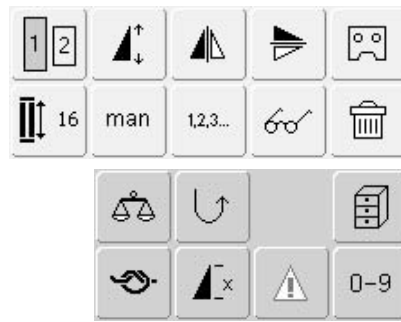

Selecting Functions

- touch the function of your choice
- the selected function is highlighted in blue (a number of different functions can be selected simultaneously)



Lowered Feed Dog

- if the feed dog is lowered this blinking symbol appears underneath the Presser Foot Indicator

Temporary Altered Stitch Memory

Stitch length, stitch width, needle position, etc. are automatically saved. When the sewing computer is turned off («0») or the «clr» (clear) button is pressed, the changes are deleted.

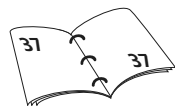

Saving Altered Settings Permanently

The basic settings programmed by BERNINA can be changed and stored in the SAA. They will stay saved even after the sewing computer is turned off («0»). The basic settings are always visible.

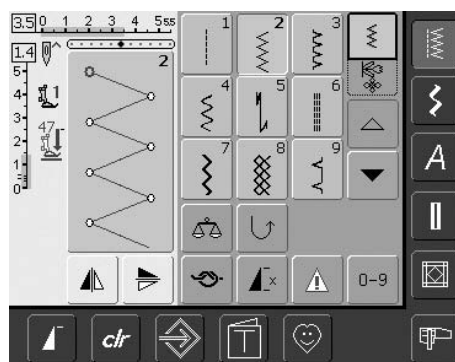

Changing Settings

- select stitch (e.g. zig-zag)
- alter the stitch width and stitch length with the external knobs
- alter the needle position with the external buttons
- touch the Stitch Altering Area (light blue)

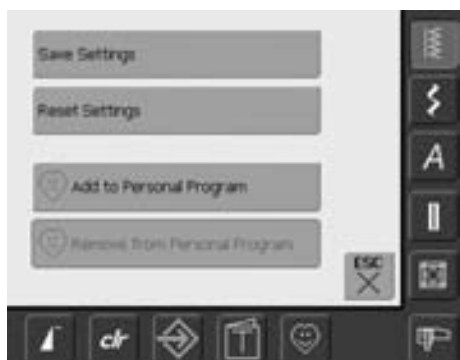

Saving Changes

- a special screen opens
- touch «Save Settings» = all changes are saved
- touch «Reset Settings» to return to basic settings
- touch «ESC» and the screen closes without anything being saved or altered

Stitch Selection

Stitches can be selected using one of the two methods listed below.



Direct Selection by Scrolling up/down Within a Stitch Category

- touch the arrow (down)
- the top row disappears
- the next two rows move up
- a new row appears at the bottom
- touch the arrow (up)
- the first row of stitches appears again
- the Scroll function (up/down) is used to find and view all the sewing computer's stitches



Stitch Selection by Number

- touch the function «0-9»
- the screen changes to a numeric pad
- touch numbers to select the stitch of your choice
- the number of the selected stitch appears in the upper screen

Correcting Mistakes

- to correct mistakes or deselect, touch function top right (arrow)
- the number is deleted from right to left
- touch the broad field above the numeric pad
- the entire number is deleted
- enter new number



If an unavailable number is entered, it will be indicated with three question marks in the field above the numeric pad.



Confirm Number and Go to Next Screen

- touch «OK» to confirm
- the selected stitch is displayed in the Stitch Altering Area
- touch «ESC»
- the screen displays the selected stitch
- the selected stitch is active (highlighted in blue)

Back to Previous Screen

- **do not** confirm the entered stitch number with «OK»
- touch «ESC» or «0-9»
- the previous screen appears
- the stitch selected by number will be ignored

Simple Menu Selection

Main Category Buttons

- press a button to select the desired menu
- the corresponding stitch category is selected immediately
- the stitches or the stitch summary appear on the screen

Practical Stitches



Practical Stitch Button

- the Practical Stitch menu appears
- 9 practical stitches appear on the screen
- use arrows to scroll for viewing additional stitches

Decorative Stitches

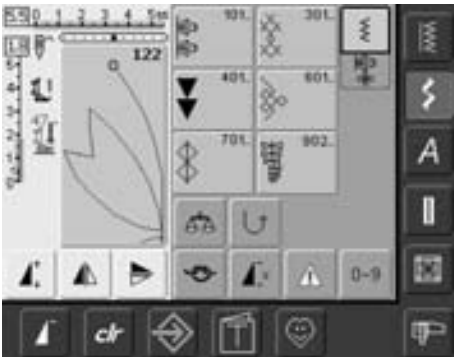

Decorative Stitch Button

- the Decorative Stitch menu appears
- the 6 categories appear on screen
- touch to select the desired stitch group
- the selected stitch group appears

Alphabets



Alphabet Button

- the Alphabet menu appears on the screen
- touch to select the alphabet of your choice

Buttonholes



Buttonhole Button

- the Buttonhole screen appears
- touch to select
- by scrolling the hand-look buttonhole will be visible

Quilting



Quilt Stitch Button

- the Quilt Stitch screen appears
- 9 quilt stitches are visible on screen
- use arrows to scroll for additional stitches

Embroidery Mode / Sewing Mode



Embroidery Mode / Sewing Mode Button

- change between Embroidery and Sewing Mode and vice versa

Personal Program

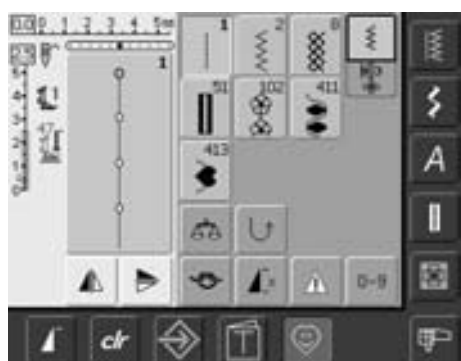

Personal Program Button

- Personal screen appears (customized settings)

Tutorial for Embroidery



Tutorial Button

- the Selection menu (menu summary) appears
- 9 menus for advice on embroidery are available on the screen

Setup Program



Setup Program

- options appear
- use Setup to customize your sewing computer's settings
- customized settings can be reprogrammed at any time or reset to BERNINA factory settings

External Function Buttons



Altering Needle Position

- left button = needle to the left
- right button = needle to the right
- keep button pressed to quickly change needle positions
- total of 11 needle positions: 5 left, 5 right and 1 center



Pattern End

- press the Pattern End button
- a stop symbol in the right part of the screen indicates that the function was activated
- sewing computer stops at the end of the active single pattern or the active pattern of a combination

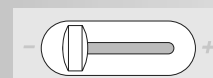

Slide Speed Control

- the motor speed can be freely adjusted with the slide



Needle Up/Down

- basic setting needle stop up
- touch the symbol briefly:
 - the needle is raised or lowered (as when tapping on the foot control with your heel)
- touch the symbol longer:
 - the needle is lowered
 - the arrow on the screen points down
 - the sewing computer stops with the needle down
- touch the symbol again (also longer):
 - the needle is raised
 - the arrow on the screen points up
 - the sewing computer stops with the needle up



Quick Reverse Button on Head Frame

- press the Quick Reverse button on head frame
- secure the seam beginning and end: sews in reverse as long as button is depressed
- used to program buttonhole length
- used to program darning length
- used to designate end of stitching in straight stitch Securing stitch No. 5
- securing with Quilters Securing Program No. 324



Securing Function (with 4 stitches)

- press the button before starting to sew = individual stitches will be secured at the beginning
- press the button during an individual stitch = the stitch will be secured at the end. The sewing computer stops
- programming the function within a stitch combination = each individual stitch of the stitch combination can be secured at the beginning or at the end



Start-Stop Button

- starts and stops the sewing computer when operating it without foot control
- starts and stops the sewing/ embroidery computer in the embroidery mode with attached embroidery module
- starts and stops the BSR function (optional) when BSR foot is attached and plugged in

General Functions

The following functions are found on various screens and programs of the artista 630 sewing computer.



Single Mode

- the Single Mode is always active (green) when turning on the sewing computer and only the selected stitch can be sewn



Combi Mode

- touch symbol
- the Combi Mode is active (green) and stitch combinations can be programmed



Pattern Begin

- touch symbol
- the needle moves to the beginning of a stitch or stitch program

Applications:

- decorative stitches, buttonholes, working in Combi Mode



Scroll Up

- touch symbol one or more times
- stitches within a stitch category scroll up to show more options
- touch the symbol continuously to scroll quickly



Scroll Down

- touch symbol one or more times
- stitches within a stitch category scroll down to show more options
- touch the symbol continuously to scroll quickly



Closing Special Applications

- touch «ESC»
- the special application closes
- returns to previous screen



OK

- touch symbol
- adjustment/selection is activated or confirmed, e.g. stitch selection by number
- programmed adjustment/selection is ready to sew



«clr» (Clear) Button

- press the «clr» button
- stitch length, width and needle position are returned to basic settings
- all active functions will be deleted

Exception:

Safety functions (e.g. double needle limitation, alphabet size)

Special Functions

The following functions are found on the artista 630 sewing computer. Each function which can be used in the selected program is either shown in the yellow part of the screen or on the two bottom rows of the gray part of the screen.



Indication of the Altered Stitch Width or Stitch Length

- return to basic setting by touching the stitch width/stitch length bar

4.00 1 2 3 4 5.55



Pattern Extend 2–5 x

- touch one or more times
- the numbers 2–5 appear depending on the type of stitch selected
- the length of selected stitch will be increased by 2–5 times
- stitch integrity is maintained
- lengthened stitches can be programmed and saved in Combi Mode
- touch the symbol longer and the function is turned off. The symbol is inactive (yellow)

Applications:

- lengthen existing stitches without affecting the stitch density
- combine stitches



Horizontal Mirror Image (left/right)

- touch symbol
- sewing computer sews selected stitch in Horizontal Mirror Image (left/right – determined by the sewing direction)
- can be programmed and saved in Combi Mode

Applications:

- blindstitch for shell edging
- decorative stitching
- stitch combinations



Vertical Mirror Image (up/down)

- touch symbol
- sewing computer sews selected stitch in Vertical Mirror Image (up/down – determined by the sewing direction)
- can be programmed and saved in Combi Mode

Applications:

- decorative stitching
- stitch combinations



Stitch Counter for Darning Program

- touch symbol
- when the desired length is reached (e.g. straight stitch), press the external Quick Reverse button
- the display (or indicator) changes to «auto»
- the Darning Program is programmed



Direct Entry Length (in mm) or On-screen Button Measurement

- touch symbol
- buttonhole length (number in mm) can be entered directly by the stitch width or stitch length knob
- for measuring the button, hold button to the left side of screen and enter button length = place the vertical black line precisely on the right side of the button
- 2mm for the button thickness will be added automatically (with button measurement only)



Programming Buttonhole Length

- symbol is automatically highlighted in blue (= active) when a buttonhole is selected
- using the Quick Reverse button on head frame a buttonhole length can be determined directly, or the displayed length can be programmed directly by touching the symbol
- when the buttonhole is programmed the symbol is turned off (inactive, yellow)
- if a new length is to be programmed the symbol has to be re-selected



Securing Function (with 4 stitches)

- touch symbol before starting to sew = individual stitches will be secured at the beginning
- touch symbol during sewing individual stitches = individual stitches will be secured at the end, the sewing computer stops
- programming the function within a stitch combination = each individual stitch of the stitch combination can be secured at the beginning or at the end

Applications:

- sewing individual decorative stitches
- sewing individual letters
- sewing stitch combinations and words



Multifunction Button

(only available in Combi Mode)

- touch symbol
- a special screen with further functions opens:
 - Delete Combination
 - Mirror Combination
 - Preview



Manual 4 or 6 Step Buttonholes

- touch symbol
- a special screen appears
- sew manual buttonhole in 4 or 6 steps (according to buttonhole type)



Pattern Repeat 1-9 x

- by touching the symbol several times the numbers 1-9 appear
- 1 = sewing computer stops at the end of an individual stitch or stitch combination
- 2-9 = sewing computer stops at the end of a stitch or stitch combination after the number of repeats selected
- touch the symbol longer and the function is turned off. The symbol is inactive (gray)

Applications:

- sewing individual motifs
- combine with practical and decorative stitches



Save

- touch symbol
- saves stitch combinations and letters



Delete

- touch symbol
- deletes individual stitches or letters above the cursor
- deletes stitch combinations
- deletes "Drawers" content



Alphabet Size

- when an alphabet is selected the size is 5.5mm (field with 1 is blue)
- touch symbol
- size will be reduced to approx. 4mm (field with 2 is blue)



Balance

- touch symbol
- Balance screen appears
- balance forwards and reverse stitches
- balance sideways motion stitches

Applications:

- adapting practical and decorative stitches to various types of fabrics (e.g. Honeycomb stitch)
- altering decorative stitches for a new look
- balancing buttonholes to different fabrics



Continuous Reverse Sewing

- touch symbol
- sews the selected stitch in reverse

Applications:

- darning with straight or running stitch
- decorative stitching on sleeves or trouser legs
- quilting



Stitch Selection by Number

- touch symbol
- special screen appears
- select individual stitch by touching the appropriate number combination

Applications:

- easy selection of individual stitch
- easy selection for stitch combination in Combi Mode



Upper Case / Lower Case

- Upper Case is activated when Block is selected
- touch symbol
- Lower Case is activated



File Drawers

- touch symbol
- the Drawers screen appears



Security Program

- touch symbol
- a special screen appears
- by selecting the respective needle symbol the stitch width will be limited automatically
- this prevents the inserted special needle (double needle, etc.) from hitting the presser foot or the stitch plate = avoiding needle breakage
- the numbers represent the distance in mm between the needles of the double and triple needle
- touch the needle symbol framed in green. The standard needle is active again and the stitch width limitation is turned off
- by selecting the respective stitch plate icon the stitch width is limited automatically so that the inserted standard needle cannot hit the stitch plate

- once a feature is active the symbol turns red
- selected functions remain active even after sewing computer is turned off («0»)/on
- touch «OK» to activate selected Security Program function
- Security Program functions must be removed within Security Program by selecting desired needle and stitch plate

Applications:

- to stitch pintucks and for hemstitching
- hemming knits
- decorative stitches
- sewing special fabrics
- piecing
- quilting

Practical Stitches

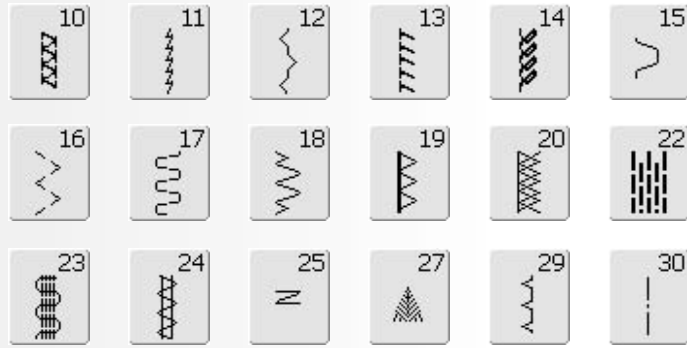
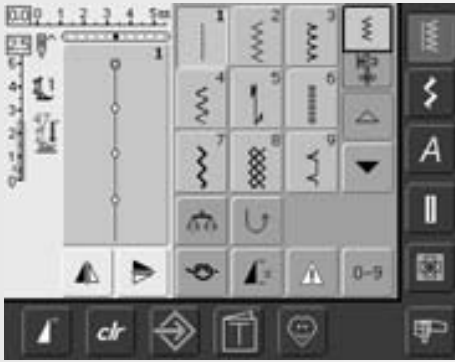

1 Straight stitch

All non-stretch fabrics. All straight stitch work



2 Zig-zag

Most fabric types. All simple zig-zag applications such as oversewing fine fabrics, attaching elastic, lace and appliqué



3 Vari-overlock

Primarily for fine jerseys, stretch overlock seams, hems and stretch seams



4 Running stitch

Most types of fabric. Mending, patching, reinforcing seams



5 Securing stitch (straight stitch)

All types of fabric. Secures the beginning and end of seams sewn with straight stitch



6 Triple straight stitch

Reinforced seams in firm, heavy fabrics, topstitching and visible seams



7 Triple zig-zag

Reinforced seams in firm fabrics, visible hems and seams, decorative stitching, couching



8 Honeycomb stitch

Most types of interlock and smooth fabrics, visible seams, hems, linens and some types of mending



9 Blindstitch

Most types of fabric. Blind hems, shell edging on soft jerseys and fine fabrics, decorative seams



10 Double overlock

All types of knit. Sews and finishes the edges in one operation



11 Super stretch

Open seam in all super-stretch fabrics, such as Lycra



12 Gathering stitch

Most types of fabric. Gathering with shirring elastic. Butted seams (edge to edge) and decorative stitching



13 Stretch overlock

Mediumweight knits, toweling and firm wovens. Overlock seams, flat joining seams



14 Jersey stitch

Natural, blended or synthetic fabrics and delicate knits. Visible seams and hems. Mending jersey/interlock

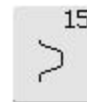

15 Universal stitch

Firm fabrics such as felt and leather. Flat joining seams, visible seams, attaching elastic, decorative seams

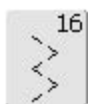
**Sewn-out zig-zag**

Oversewing woven fabrics, reinforcing edges, attaching elastic, decorative seaming

**Lycra stitch**

All two-way stretch fabrics, flat joining seams and hems, reinforced seaming on underwear

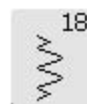
**Stretch stitch**

All stretch fabrics, open seam in sportswear

**Reinforced overlock**

Medium-to heavyweight knits and toweling, overlock seams, flat joining seams

**Knit overlock**

All knits, machine or handmade, overlock seam. Sews and finishes edges in one operation

**Simple darning program**

Automatic darning in fine and mediumweight fabrics

**Reinforced darning program**

Automatic darning in heavyweight fabrics

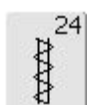
**Bartack program**

Reinforcing pocket edges, belt loops, etc.

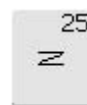
**Bartack program**

Reinforcing pocket edges, belt loops, securing zippers

**Fly stitch small**

Fine to mediumweight fabrics, reinforcing pocket edges, zippers and openings

**Blindstitch narrow**

Blind hems on fine fabrics

**Basting**

Basting seams, hems, etc

Adjusting Individual Practical Stitches

Depending on the fabric and application an alteration of the basic settings may be necessary.

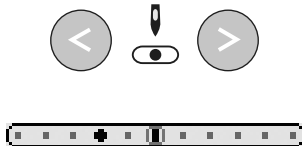

Altering Stitch Width and Stitch Length

- depending on the fabric it may be necessary that the stitch width or the stitch length is altered
- can be altered while sewing
- use stitch width or stitch length knob to make alteration

Changing the Needle Position

- press external Needle Position buttons to change the needle position, so stitching can be placed exactly where it is required
- there are a total of 11 needle positions (5 left, 5 right, and 1 center)
- keep button pressed to change needle positions quickly

Securing With Quick Reverse Button (on Head Frame)

- secures the seam beginning and end
- press the Quick Reverse button and the sewing computer sews in reverse
- release the Quick Reverse button and the sewing computer sews forwards

Practical Stitch Seams

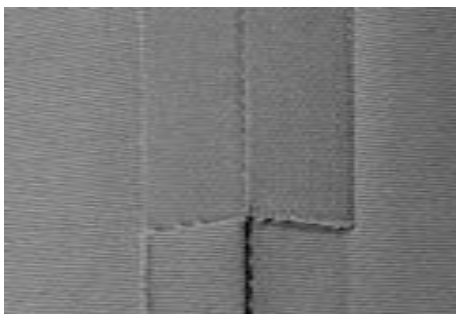

Open Seams

Seams where the seam allowance is pressed open

- seam allowance up to 5/8" (1.5cm)
- seam lies flat
- seam does not stretch

Suggested stitches:

- straight, narrow zig-zag, super stretch, and triple zig-zag

Application:

- for woven fabrics
- works for most types of sewing projects, including clothing, home accessories, and crafts



Overlock Seams

Seams which cannot be pressed open

- sewn and finished in one operation
- narrow seam allowances

Suggested stitches:

- vari-overlock, double overlock and jersey

Application:

- for knits and jerseys
- excellent for knit clothing, lingerie, bed linens and Jersey

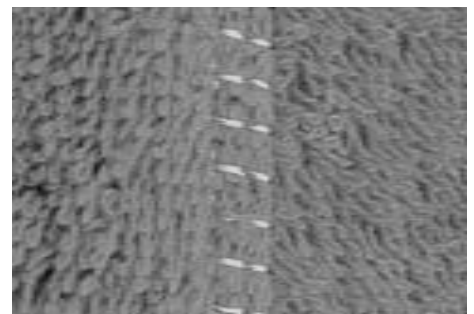

Flat Joining Seams

Seams where the edges are overlapped and then sewn

- stitching is on the seam allowances

Suggested stitch:

- stretch-overlock

Application:

- particularly good for toweling and Lycra
- also good for beachwear, leisure wear, and lingerie

Temporary Altered Stitch Memory

Stitch: **any selected stitch**



The altered memory can hold as many stitch alterations as needed (these are stitch length, stitch width, Needle Position, Pattern Extend, Mirror Images, Balance and Pattern Repeat function 1-9x).

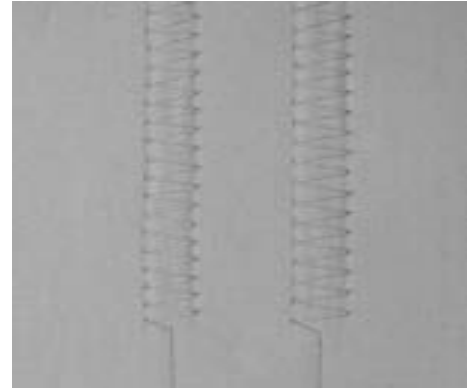

Temporary Altered Stitch Memory

- stitch length, stitch width, needle position, etc. are automatically saved
- by altering the stitch width and stitch length, all stitches can suit both the fabric and sewing
- the Temporary Altered Stitch Memory is particularly useful when alternating between two applications, such as overcasting edges, zig-zag, vari-overlock to suit the fabric
- the stitches can be changed as needed
- when changing back to the altered stitch, the previous individually altered setting will stay saved

Return to Basic Settings – Delete Altered Stitch Memory

- Method 1: press the «clr» button (active stitch in basic setting)
- Method 2: revert to the stitch width and length by touching the stitch width/stitch length bar (or manually by turning the external knob) revert to other functions manually
- Method 3: turn sewing computer off («0») – altered settings will not be saved

Example:

- select Zig-zag stitch No. 2 and alter stitch width to 5.5mm (e.g. overcasting an edge)
- select straight stitch and sew seam
- overcasting another edge: select the Zig-zag stitch No. 2 again
- the altered setting of the stitch width to 5.5mm stays saved



Save the stitch with altered basic settings in the Personal Program.



Save the settings permanently.

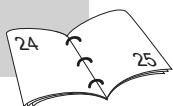

Straight Stitch



Stitch: **Straight stitch No. 1**
 Needle: **size and type suitable for the fabric selected**
 Thread: **cotton or polyester**
 Feed dog: **up (sewing position)**
 Presser foot: **Reverse pattern foot No. 1**

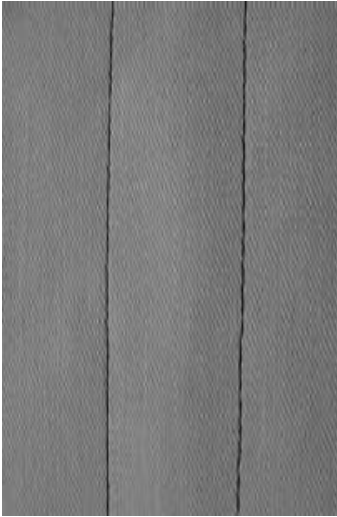

Straight Stitch

- after turning the sewing computer on, the Practical Stitch screen with the activated straight stitch appears

Application

- suitable presser foot to be selected according to the technique, e.g. manual darning
- suitable for all fabrics

Adjust the stitch length to suit the fabric

For example use a longer stitch length (approximately 3 - 4mm) with denim, a shorter length (2 - 2.5mm) with batiste.



Adjust the stitch length to suit the thread

For example use a longer stitch length (approximately 3 - 5mm) when sewing with cordonnet thread for topstitching.

Activate needle stop down

Prevents the fabric from slipping when you stop to adjust stitch or pivot.

Triple Straight Stitch Seam



Stitch: **Triple straight stitch No. 6**
 Needle: **Jeans or 80-90 universal**
 Thread: **cotton or polyester**
 Feed dog: **up (sewing position)**
 Presser foot: **Reverse pattern foot No. 1 or Jeans foot No. 8 (optional accessory)**

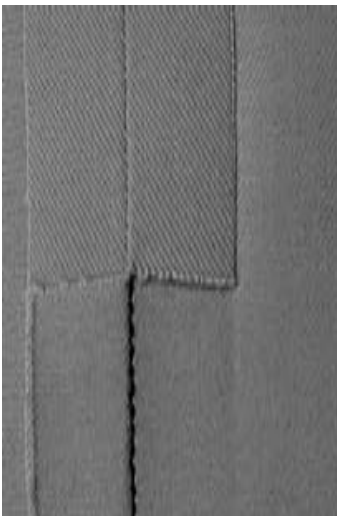

Open Seam

- durable seam for firm and densely woven fabrics such as denim and corduroy
- reinforced seam subject to hard wear

For heavy layers or very densely woven fabrics:

A Jeans needle or Jeans foot No. 8 will help when sewing very heavy fabrics, such as denim or canvas.



Decorative top stitch

Lengthen out stitch and use as a decorative top stitch with denim.

Securing Stitch (Straight Stitch With Securing)



Stitch: **Securing stitch No. 5**
 Needle: **size and type suitable for the fabric selected**
 Thread: **cotton or polyester**
 Feed dog: **up (sewing position)**
 Presser foot: **Reverse pattern foot No. 1**

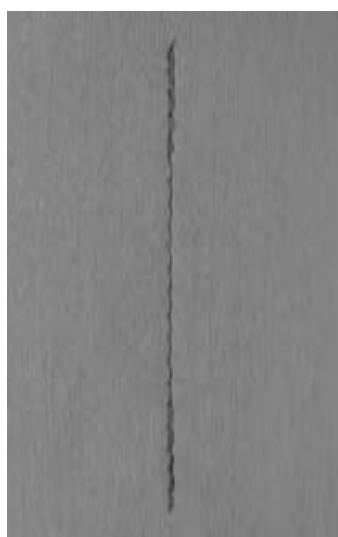

Securing Stitch

- for all fabrics
- secures beginning and the end of seam
- reverse stitching is exactly on top of the seam, preventing puckers

Beginning the Seam

- the sewing computer secures the seam automatically (5 stitches forward, 5 stitches reverse)
- the sewing computer continues straight stitching forwards

Ending the Seam

- when coming to the end of the seam, press and release the Quick Reverse button on head frame. The sewing computer will then secure the seam automatically (5 stitches reverse, 5 stitches forward)
- sewing computer stops automatically when securing is completed



Seaming or sewing long seams

- quicker securing at beginning and end of seam
- even securing by defined stitch count



Edgestitching

- Stitch: **Straight stitch No. 1**
 Needle: **size and type suitable for the fabric selected**
 Thread: **cotton, polyester or cordonnet (topstitching)**
 Feed dog: **up (sewing position)**
 Presser foot: **Reverse pattern foot No. 1, Blindstitch foot No. 5 or Edge stitch foot No. 10 (optional accessory)**

Narrow Edgestitching

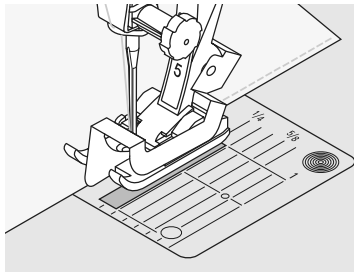

Outer Edges

- place edge of fold against the guide on the Blindstitch foot
- select needle position at desired distance from the folded edge

Needle Position

- left for outer edge
- right for inner edge (hem edges)

Presser Foot

- Blindstitch foot No. 5

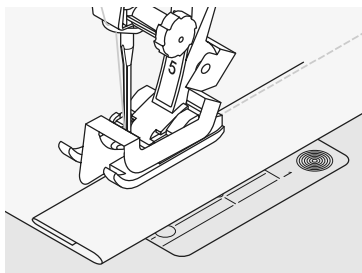

Hem Edges

- place edge of fold against the guide on the Blindstitch foot (inside upper edge of hem)
- select needle position right to sew along the upper edge



Foot No. 5:
use any left or far right needle position
Foot No. 10:
use any left or right needle position

Wide Edgestitching

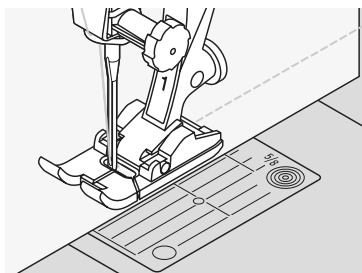

Guiding the Fabric

Presser foot as a Guide:

- guide the folded edge along the edge of the presser foot

Stitch Plate as a Guide:

- guide the folded edge along the marks on the stitch plate (for stitching 3/8" to 1 1/8" (1 to 2,5 cm) from the edge)

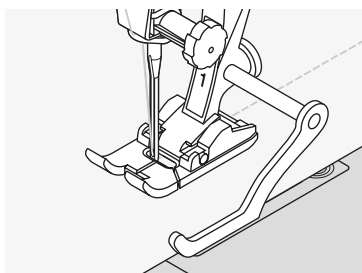

Seam Guide:

- insert the seam guide into the hole on the back of the presser foot shaft
- adjust as desired
- tighten the screw
- guide the folded edge along the seam guide
- to sew parallel wider lines, guide the seam guide along a previously sewn line of stitches

Needle Position

- any needle position can be used according to the width of the stitching

Presser Foot

- Reverse pattern foot No. 1

Zig-zag Stitch



Stitch: **Zig-zag stitch No. 2**
 Needle: **size and type suitable for the fabric selected**
 Thread: **cotton or polyester**
 Feed dog: **up (sewing position)**
 Presser foot: **Reverse pattern foot No. 1**

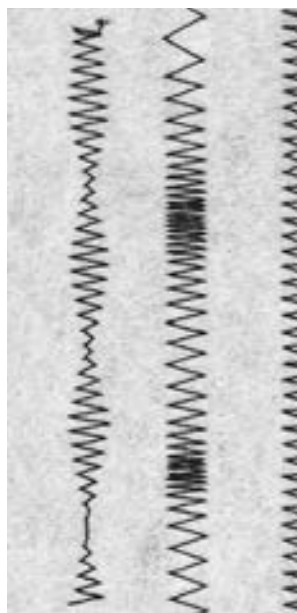

Zig-zag Stitch

- suitable for all fabrics
- overcasting
- elastic seams
- decorative sewing

Oversewing Edges

- guide edge of fabric into the center of the presser foot
- do not select too wide a width or too long a stitch – the edge should lie flat and not roll
- needle goes into fabric on one side and over the edge into the air on the other side
- use a fine darning thread for lightweight fabric

Satin Stitch

- dense stitch used for appliqué, embroidery, etc.
- shorten stitch length, satin stitch setting will be indicated by parallel lines on stitch length bar



Oversewing edges

If edges roll, use the Vari-overlock stitch and foot No. 2.

Embroidery with satin stitch

Experiment with adjusting the stitch width for new decorative effects.



The sewing computer has a programmed satin stitch: No. 354

Darning Program



- Stitch: **Simple darning program No. 22,
Reinforced darning program No. 23**
- Needle: **size and type suitable for the fabric selected**
- Thread: **lightweight darning thread**
- Feed dog: **up (sewing position)**
- Presser foot: **Automatic buttonhole foot No. 3A, Reverse pattern foot No. 1 (only for Darning program No. 22)**

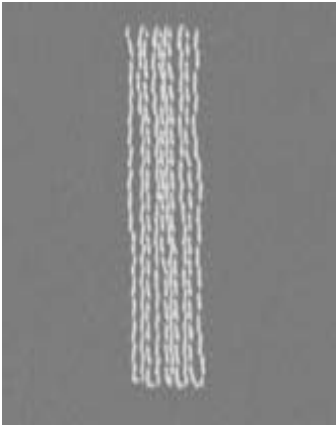

Simple Darning Program No. 22

replaces threads along the lengthwise grain in all fabrics

Preparation

- place a piece of lightweight stabilizer under the worn area before darning if necessary

Sewing

- sew the first row and stop
- press and release the Quick Reverse button at the desired length; this programs the first length
- continue sewing; the sewing computer stops automatically



The Simple darning program No. 22 can also be done with the Automatic buttonhole foot No. 3A (see following description).

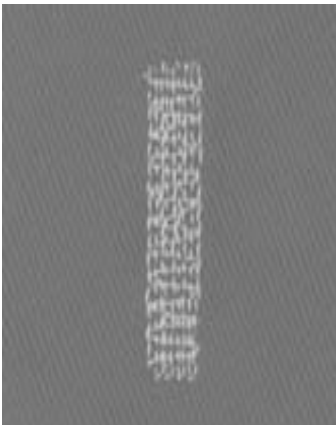

Reinforced Darning Program No. 23

replaces threads along the lengthwise and crosswise grains in all fabrics

Preparation

- use Automatic buttonhole foot No. 3A
- place a piece of lightweight stabilizer under the worn area before darning if necessary

Sewing

- insert the needle in the top left of the worn area
- sew the first vertical row
- press and release the Quick Reverse button at the desired length; this programs the length needed
- continue sewing; the sewing computer stops automatically when finished



If the darning does not cover the whole worn or damaged area

reposition the work under the foot to continue covering the worn or damaged area. Begin sewing; the program will repeat as often as desired (the length is saved)



If the darning becomes distorted

correct with the Balance function see page 102

Manual Darning

| | |
|---------------|---|
| Stitch: | Straight stitch No. 1 |
| Needle: | size and type suitable for the fabric selected |
| Thread: | darning thread |
| Feed dog: | down (darning position); |
| Presser foot: | Darning foot No. 9 |

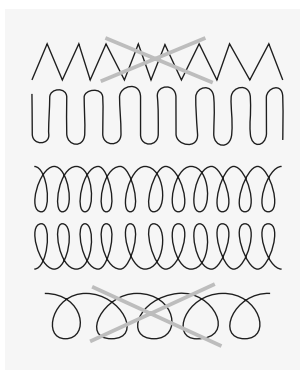
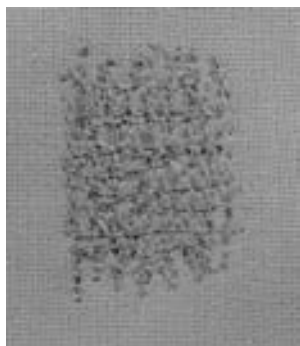

Darning Holes or Worn Areas

Replaces both lengthways and crossways threads in all fabrics.

Preparation

- stretch fabric into darning hoop (optional accessory) to prevent distortion
- use the slide-on table

Sewing

- move the darning hoop smoothly by hand
- work from left to right without using pressure
- when changing direction on top and on bottom, move in curves (avoid points as this prevents holes and thread breakage)
- work in different lengths so that the thread is better spread over the fabric

Poor stitch formation

- if the thread is lying on the right side of the fabric, the hoop is being moved too quickly
- if there are knots on the wrong side of the fabric, the hoop is being moved too slowly



Thread breaks

- if thread breakage is a problem, it could be that the hoop is not being moved smoothly

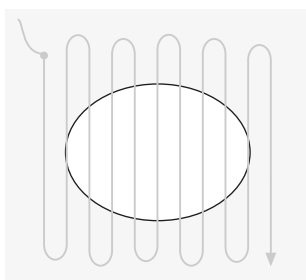

1. Stitch Over the Hole

- sew the first rows to cover the hole (not too close, sewing beyond the worn area)
- work the rows in irregular lengths
- turn work by a quarter turn - 90°

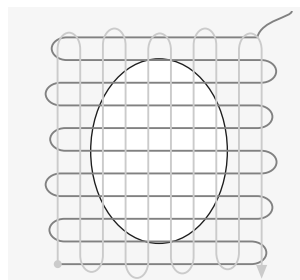

2. Cover the First Rows

- sew over the first rows - not too close for a soft finish
- turn work by a half turn - 180°

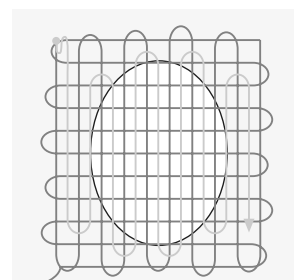

3. Complete Darning

- sew loosely and in same direction as 2nd rows

Sewing Knit Fabrics

Start With a New Needle

- blunt needles can damage knits

Use a Stretch Needle (130/705 H-S) if Necessary

- the needle point slides easily between the fibers

Use a Fine Sewing Thread

- coarse threads can damage knits and cause holes when the garment is washed

When Basting, Use a Darning Thread

- very lightweight (80 weight) darning thread is easier to remove once the seam is complete

Sew a Test if Necessary

- the elasticity of today's knit fabrics varies greatly
- adjust basic settings to suit the fabric, the seam should be as elastic as the fabric
- for greater elasticity use a shorter stitch length and/or stitch width (only one of these adjustments may be necessary)

Presser Foot Pressure

- soft, loose knits can wave when sewn:
- reduce the pressure until the seam lies flat
- the sewing computer must still feed the fabric properly

Possible Problems With Sewing Knits

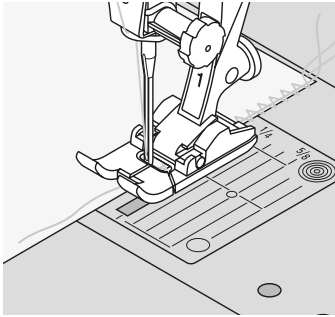

Seam Becomes Wavy

- oversew a thread along the edge
- after sewing adjust edges by pulling the thread to regain the original length of the fabric and press seam flat

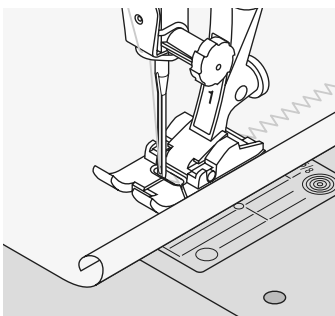

Edges Roll

- do not sew right on the edge but about 5mm in from the edge
- cut off allowance after finished sewing

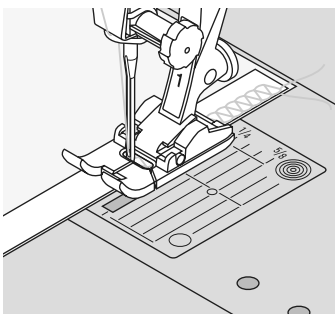

Seams Which Pull or Stretch

- reinforce seams with a ribbon (e.g. shoulder ribbon) before sewing
- different stretch ribbons are available. These can be sewn to give more security to the seam

Vari-overlock Seam



- Stitch: **Vari-overlock No. 3**
 Needle: **size and type suitable for the fabric selected**
 Thread: **cotton or polyester**
 Feed dog: **up (sewing position)**
 Presser foot: **Overlock foot No. 2 or
 Reverse pattern foot No. 1**

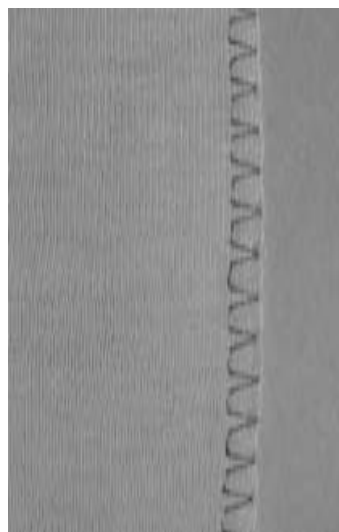

Overlock foot No. 2 is specially designed for overlock stitches. The pin on the foot allows for more thread in each stitch so that the elasticity of the seam is maintained.

Closed Seam

Stretchy seam in fine, soft knits such as silk jersey and interlock.

Sewing

- guide the raw edge along the pin on the overlock foot
- the stitch will form over the pin and over the edge of the fabric

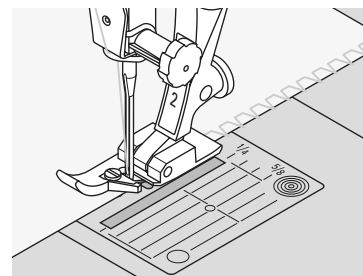

Knits and jersey

- use a new ball point needle to prevent damaging the loops

Sewing stretch fabrics

- if necessary use a stretch needle (130/705H-S) = needle point slides between the fibers



Double Overlock Seam



- Stitch: **Double overlock No. 10**
 Needle: **size and type suitable for the fabric selected**
 Thread: **cotton or polyester**
 feed dog: **up (sewing position)**
 Presser foot: **Reverse pattern foot No. 1**

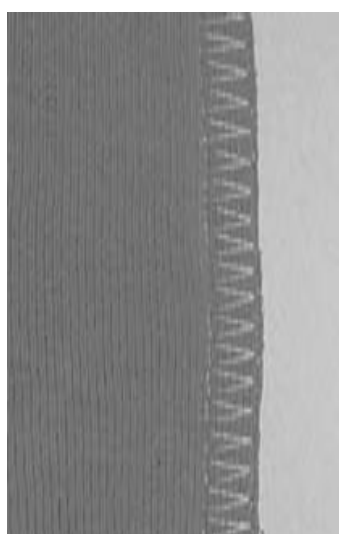

Closed Seam

Overlock seam in loose knits and cross seams in knits and jerseys.

Sewing

- sew the overlock seam along the raw edge

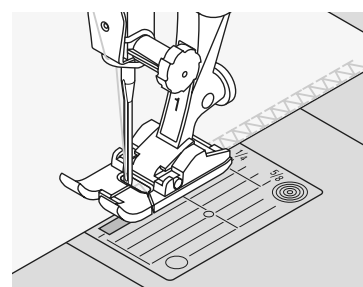

Stretch Overlock Seam/Reinforced Overlock Seam

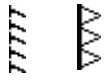

Stitch: **Stretch overlock No. 13
or Reinforced overlock No. 19**
 Needle: **universal, ballpoint or stretch**
 Thread: **cotton or polyester**
 Feed dog: **up (sewing position)**
 Presser foot: **Reverse pattern foot No. 1 or
Overlock foot No. 2**

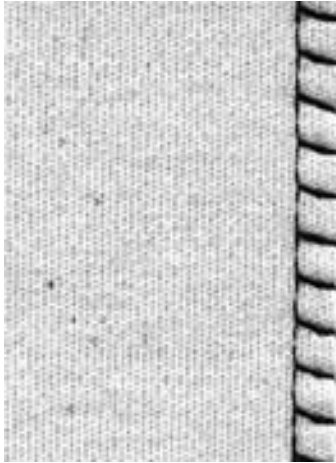

Closed Seam

- overlock seam in coarse or loose knits

Sewing

- sew stretch overlock along the fabric edge
- the stitch should sew over the edge of the fabric on the right swing of the needle

Super Stretch/Stretch Seam

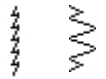

Stitch: **Super stretch No. 11 or Stretch No. 18**
 Needle: **universal, ballpoint or stretch**
 Thread: **cotton or polyester**
 Feed dog: **up (sewing position)**
 Presser foot: **Reverse pattern foot No. 1**

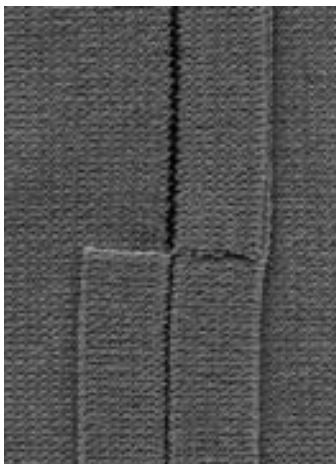

Open Seam

- very elastic seam for knit fabrics
- ideal for sports and leisure wear
- seam lies flat and is not bulky



When using heavyweight fabrics (rolling edges) sew 3/8" (1cm) in from the edge and cut off seam allowance.

Flat Joining Seam



Stitch: **Stretch overlock No. 13**
 Needle: **universal, ballpoint or stretch**
 Thread: **cotton or polyester**
 Feed dog: **up (sewing position)**
 Presser foot: **Reverse pattern foot No. 1**

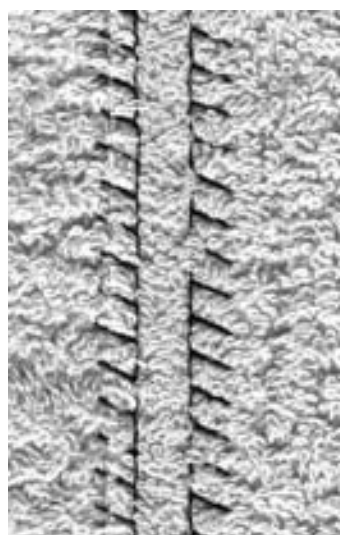

Flat Joining Seam

- fabric edges are overlapped and the stitch is placed on the seam allowance which produces a very flat, durable seam
- ideal for fluffy, thick materials such as terry cloth, felt and leather

Sewing

- sew stretch overlock along the fabric edge
- the stitch should sew over the edge of the top layer of fabric on the right swing of the needle

Fabric and thread

When using a matching thread color, this seam is hardly visible in fluffy fabrics.



Thick seam

Particularly suitable for fabrics in which a normal straight stitch seam would stretch open.

Hems With Practical Stitches



Stitch: **Jersey stitch No. 14**
 Needle: **universal, ballpoint or stretch**
 Thread: **cotton or polyester**
 Feed dog: **up (sewing position)**
 Presser foot: **Reverse pattern foot No. 1**

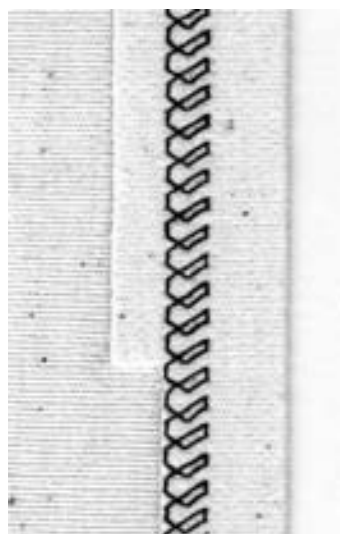

Visible Stretch Hem

- for all types of cotton, wool, synthetic and mixed fiber jerseys

Preparation

- Fold hem, pin if necessary

Sewing

- sew hem at desired depth (right side)
- trim excess fabric (wrong side)

Ribbing With Overlock Seams

www

Stitch: **Vari-overlock No. 3**
 Needle: **size and type suitable for the fabric selected**
 Thread: **cotton or polyester**
 Feed dog: **up (sewing position)**
 Presser foot: **Overlock foot No. 2**

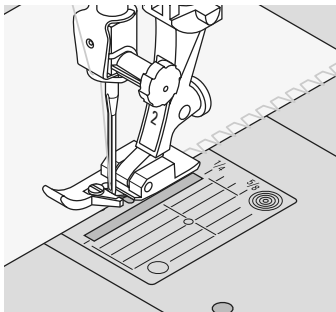

Ribbing With Overlock Seam

- for all fine cotton, synthetic and mixed fiber knits

Preparation

- cut ribbing twice the finished width plus double the seam allowance
- fold ribbing in half
- pin and baste to opening, front edge to outside

Sewing

- sew vari-overlock over the raw edge
- guide the raw edge along the pin of the foot
- the stitch will form over the pin and over the edge of the fabric



Back



Front



Preventing the ribbing from becoming wavy

Cut ribbing slightly shorter than the opening and pull slightly when pinning.

Needle stop down

Needle stays in fabric when pivoting around curves (neck edges and armholes).

Zipper

| | |
|------------------|--|
| Stitch: | Straight stitch No. 1 |
| Needle: | size and type suitable for the fabric selected |
| Thread: | cotton or polyester |
| Feed dog: | up (sewing position) |
| Presser foot: | Zipper foot No. 4 or Zipper foot with guide No. 14 (optional accessory) |
| Needle position: | far right or far left |



Preparation

- baste seam closed and clean finish the seam allowance
- baste or pin zipper in place so that fabric folded edges meet over the center of the zipper

Sewing

- open zipper a little
- start sewing from top left
- position the foot so the needle stitches along the edge of the zipper coils
- stop in front of the pull (needle position down), raise the presser foot and close zipper again
- continue to sew to the base of the zipper (needle position down)
- turn fabric and sew across the seam (needle position down)
- turn fabric again and sew second side of the zipper from bottom to top

Variation: Sew both sides of zipper from bottom to top

- suitable for all fabrics with nap or grain (e.g. velvet)
- prepare zipper as described above
- start sewing in the seam of the zipper end and sew first side from bottom to top
- sew the second side the same way from bottom to top

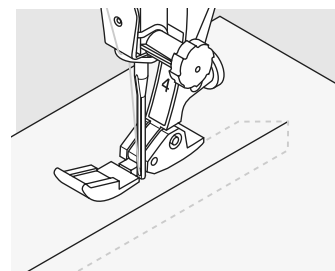

Zipper as a decorative element

- sew a visible zipper into the fabric as a decorative element

To sew around the zipper pull

- close the zipper and sew up to about 2" (5cm) away from the pull
- stop with the needle down in the fabric, raise the presser foot. Open zipper, pulling the tab below the needle; lower presser foot and continue to sew



Starting to sew

- hold threads firmly when starting to sew and pull the fabric gently behind the needle for a few stitches

Zipper tape or firm fabric

- for even stitch formation use a 90 - 100 needle

Blind Hem



- Stitch: **Blindstitch wide No. 9,
Blindstitch narrow No. 29**
- Needle: **size and type suitable for the fabric selected**
- Thread: **cotton, polyester, silk or monofilament**
- Feed dog: **up (sewing position)**
- Presser foot: **Blindstitch foot No. 5**

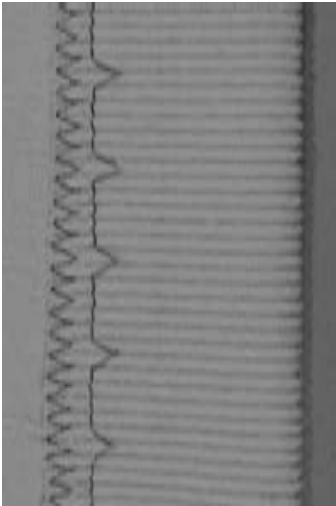

Blind hem wide



Blind hem narrow

Blind Hem Wide No. 9

- for invisible hems in medium to heavy fabrics

Blind Hem Narrow No. 29

- for invisible hems in batiste

Preparation

- finish the raw edges as desired
- fold the hem and baste or pin in place
- fold the garment back over the right side of the fabric to expose the finished lower edge (see drawing)
- place the work under the presser foot with the guide positioned against the folded back fabric

Sewing

- the needle should just pierce the edge of the fold
- after sewing about 4" (10cm), check both sides of fabric and adjust the stitch width if necessary



Fine stitch width adjustment

- sew a test on the fabric. Adjust the stitch width to suit the fabric so that the needle just pierces the edge of the fold
- guide the raw edge along the guide on the foot to keep the stitch depth even

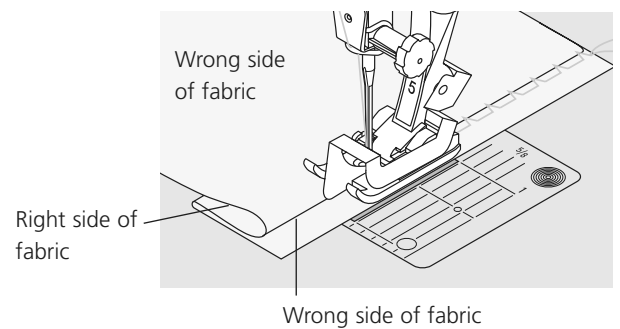

Honeycomb Stitch Edges



Stitch: **Honeycomb stitch No. 8**
 Needle: **universal, ballpoint, or stretch**
 Thread: **cotton or polyester**
 Feed dog: **up (sewing position)**
 Presser foot: **Reverse pattern foot No. 1**

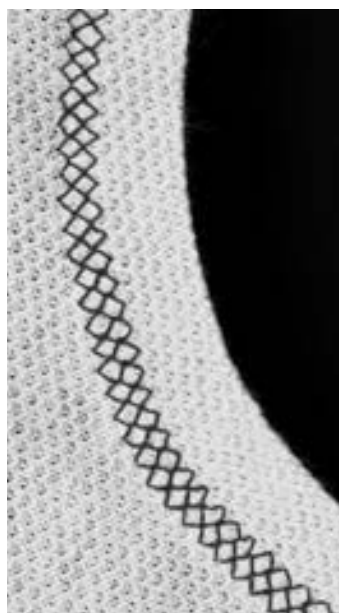

Honeycomb Stitch Edges

- for all cotton, wool, synthetic and mixed fiber knits

Preparation

- turn the raw edge under by 3/8" (1cm);
press and baste if required

Sewing

- sew from the right side a presser foot
away from the edge
- trim excess fabric from the wrong side

Balance/Corrections

The Honeycomb stitch opens up and it does not look correct:

- turn the stitch length knob until the stitch
in the right portion of the screen is
identical with the stitch on the fabric



Needle stop down

Needle stays in fabric when pivoting around curves (neck edges and armholes).



Sewing on Elastic, Shirring Elastic/Cord



Stitch: **Universal stitch No. 15**
 Stitch width: **depends on width of elastic**
 Needle: **type and size to suit the fabric selected**
 Thread: **cotton or polyester**
 Feed dog: **up (sewing position)**
 Presser foot: **Reverse pattern foot No. 1 or Embroidery foot No. 6 (optional accessory)**



Sewing on Elastic

- for gathering long lengths of fabric
- for ruffles and flounces in fine fabrics, outer garments, sportswear, children's and doll clothing, crafts, etc.
- works well for gathered sleeve edges and neck openings

Preparation

- cut elastic to length required

Sewing

- oversew the elastic, adjusting the stitch width to be slightly wider than the elastic
- needle must not pierce the elastic
- after sewing, adjust the gathers evenly

Secure the beginning and end of elastic

Sew a few straight stitches backwards and forwards to secure the elastic.



Quick hem finish

- for children's or doll clothing
- sew sleeve edges with elastic before sewing seams

Basting Stitch

| | |
|---------------|---|
| Stitch: | Basting stitch No. 30 |
| Needle: | size and type suitable for the fabric selected |
| Thread: | cotton/polyester/leightweight darning thread |
| Feed dog: | down (darning position) |
| Presser foot: | Darning foot No. 9 |

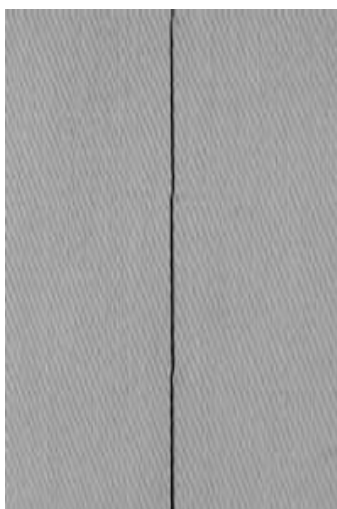

Basting Stitch

- for all work which requires a very long stitch
- for basting seams, hems, quilts, etc.
- easy to remove

Preparation:

- pin work horizontally to basting direction to prevent the layers slipping

Basting

- lower the feed dog
- position work under the presser foot and sew one stitch; hold threads when starting to sew
- pull work from behind to the required length of the stitch
- sew one stitch and repeat the procedure

Securing/fixing the thread

- sew a few basting stitches at the beginning and end of a seam



Basting

- use a fine darning thread for basting as it is easier to remove

Piecing Stitch / Straight Stitch

| | |
|----------------|--|
| Stitch: | Straight stitch No. 1 |
| Stitch length: | 1.5mm – max. 2mm |
| Needle: | size and type suitable for the fabric selected |
| Thread: | cotton or polyester |
| feed dog: | up (sewing position) |
| Presser foot: | Patchwork foot No. 37 (optional accessory) Patchwork foot No. 57 (optional accessory) |



Patchwork Foot

Accuracy is essential when sewing patches together. The side edges of the Patchwork foot are exactly 1/4" (6mm) from the center needle position. The center indents on either side of the foot indicate the needle insertion point and the two additional indents are 1/4" (6mm) in front of and behind the needle. When you sew at a foot's width, the seam allowances will always be of the exact width and it is easy to turn the work while maintaining the same width.

Piecing patchwork is sewn with a straight stitch. A stitch length of 1.5-2 mm is ideal. It is not necessary to secure the stitches for these relatively short seam lengths. Attach the slide-on table for precise and easier work.

Decorative Stitches

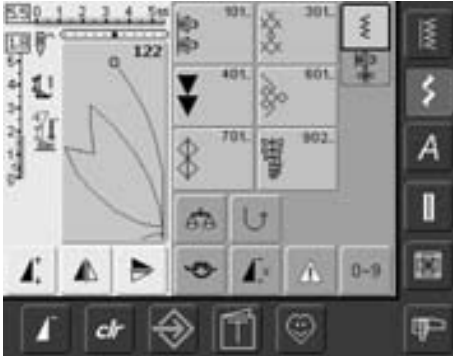

Decorative Stitches

- press Decorative Stitch button

Selecting Decorative Stitches

- press Decorative Stitch button
- a complete overview appears on the screen:
- 101, ..., 301, ..., 401, ..., 601, ..., 701, ..., 902, ...
- touch the appropriate button to select and activate the desired category
- select the desired stitch

Application of Various Decorative Stitches

Depending on the type of fabric, select simple or more complicated decorative stitches to enhance the fabric.

- lightweight fabrics
- use simple decorative stitches for a particularly nice effect on lightweight fabric (e.g. Decorative stitch No. 101)
- mediumweight fabrics
- simple and more complicated decorative stitches - programmed with triple straight stitch or with a few satin stitches - are particularly suitable for mediumweight fabrics (e.g. Decorative stitch No. 615)
- heavyweight fabrics
- use more intricate decorative stitches - programmed with satin stitches - on heavyweight fabrics for outstanding decorative stitching (e.g. Decorative stitch No. 401)



Perfect Stitch Formation

- use the same needle and bobbin thread color
- use a stabilizer on the wrong side of the fabric for perfect stitch formation
- use an additional, water soluble stabilizer on the right side of pile or longfiber fabrics (e.g. wool, velvet, etc.)

Applications

Stitch: **Decorative stitches**
 Needle: **size and type suitable for the fabric selected**
 Thread: **cotton, decorative**
 Feed dog: **up (sewing position)**
 Presser foot: **Reverse pattern foot No. 1,
 Open embroidery foot No. 20,
 Embroidery foot No. 6 (optional accessory),
 Clear foot No. 34 (optional accessory)**



Altering the Stitch Width

- for decorative effects and stitch adjustments (e.g. in bulky places)
- wider = turn the external stitch width knob clockwise
- narrower = turn the external stitch width knob counter clockwise
- basic settings and the alterations made will be displayed on screen
- reset basic settings = touch the stitch width bar or press the «clr» button, or turn the external knob



Altering the Stitch Length

- for decorative effects and stitch adjustments (e.g. in bulky places)
- longer = turn the external stitch length knob clockwise
- shorter = turn the external stitch length knob counter clockwise
- basic settings and the alterations made will be displayed on screen
- reset basic settings = touch the stitch length bar or press the «clr» button, or turn the external knob



Saving altered basic settings

- save the stitch with its altered settings in your Personal Program

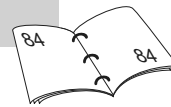

Change the factory settings of the stitch permanently

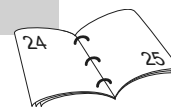

Combining Decorative Stitches and Functions

- Stitch: **Decorative stitches**
 Needle: **size and type suitable for the fabric selected**
 Thread: **cotton, decorative**
 Feed dog: **up (sewing position)**
 Presser foot: **Reverse pattern foot No. 1 or
 Open embroidery foot No. 20,
 Embroidery foot No. 6 (optional accessory),
 Clear foot No. 34 (optional accessory)**

Create amazing effects by combining decorative stitches and functions.

Instructions

- select desired stitch
- select desired function
- the altered stitch is displayed on screen
- a single stitch can be combined with several functions

Mirroring Decorative Stitches

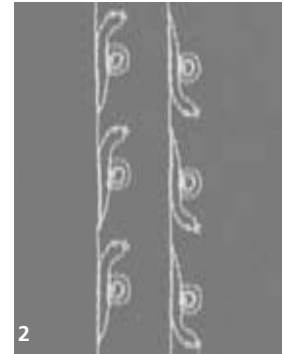
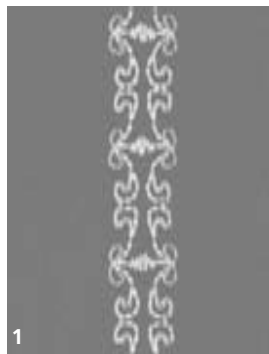

Deleting Functions



- press the «clr» button or delete special functions individually by touching the appropriate function

- touch the Horizontal Mirror Image (left/right) function
- the stitch is mirrored left/right

- touch the Vertical Mirror Image (up/down) function
- the stitch is mirrored in the sewing direction, up/down
- touch both Mirror functions simultaneously
- the stitch is mirrored vertically and horizontally

Stretching Decorative Stitches With Pattern Extend Function (1)

- touch the Pattern Extend function once or more
- the selected stitch is extended (i.e. stretched) two- to fivefold
- some stitches have limited extension capability, and thus cannot be stretched to 3 to 5 times their previous size

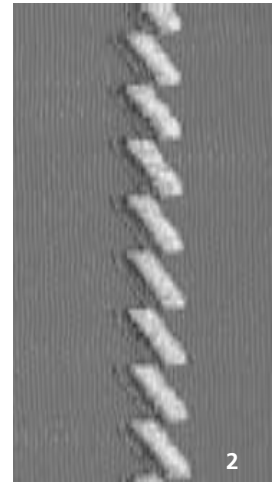
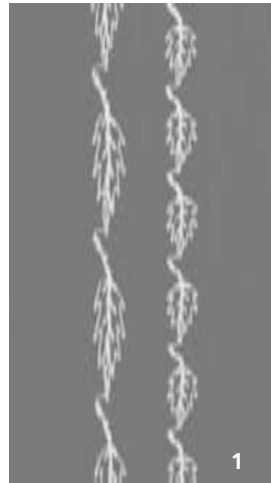

Sewing With a Double, Triple or Wing Needle (2)

- on inserting the specialty needle activate the Security Program
- when selecting the stitch, the stitch width is automatically limited according to the needle chosen
- the best effects are achieved with simple stitches

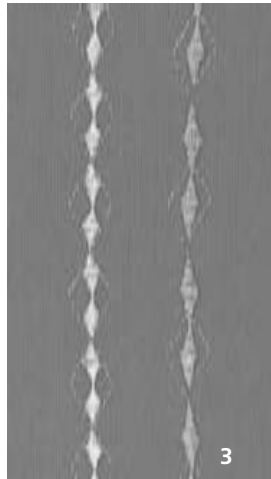

Balance (3)

- use the Balance function for various effects (stitch variations)

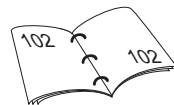

Add «Pattern End»/«Pattern Repeat»

- touch the external Pattern End button: the sewing computer will stop at the end of an individual stitch or the active stitch in a combination
- touch the Pattern Repeat 1-9x function on the screen: the sewing computer will stop on completion of the number of single repeats entered



Practical and Decorative Stitches in the Combi Mode



- select «Combi Mode»
- the Combi Mode opens, and is ready to create stitch combinations



Combining Practical and Decorative Stitches

- select desired stitch
- stitch appears in the stitch display
- select another stitch
- continue in this way until the desired stitch combination is completed

- correcting in a combination see page 90 - 91
- saving a combination see page 87 - 88

Most of the practical and decorative stitches can be combined, except for the following special programs:

Securing program No. 324, Securing stitch No. 5

Basting No. 30

Darning No. 22 and No. 23

Bartacks No. 24 and No. 25

Fly stitch No. 27

Stitches in the buttonhole category Nos. 51 - 63



Mirroring complete combination left/right

- touch Multifunction button
- touch «Mirror Image»
- the complete combination is mirrored left/right



Add Securing function (4 small securing stitches)

There are various options for automatically securing stitches:

1. touch «Securing» before beginning to sew: securing stitches are stitched at beginning of stitch combination
2. programming a function within a stitch combination: the desired stitches are secured accordingly

Example of a Stitch Combination

- Machine Embellishment stitches: touch stitch No. 655 once
- open Practical Stitches window and touch Straight stitch No. 1 once
- open Decorative Stitches window and touch stitch No. 606 in Machine Embellishment stitches once
- open Practical Stitches window and touch Straight stitch No. 1 once
- the stitches alternate continuously as you sew



Example of a Stitch and Function Combination

- touch stitch No. 656 once
- touch stitch No. 656 again and activate Vertical Mirror Image function to mirror the stitch in the sewing direction
- the stitch is mirrored in the sewing direction
- the stitches alternate in their original and mirrored form as you sew



Alphabet Summary

- 3 different alphabets are available
- each of the alphabets can be sewn in two different sizes.
Block lettering in lower case can only be stitched in one size
- Block lettering can also be sewn in lower case

Application

- for names and addresses
- for words and texts
- for labeling quilts (quilt labels)
- for labeling (labels)



Alphabets

- press Alphabet button



Alphabet Summary

- Alphabet summary appears
 - **Block**
 - **Double Block**
 - **Script (Italics)**
- touch one of the buttons to select
- the desired alphabet is activated



On-screen Letter Selection

- scroll up and down to view all capital letters, numbers, punctuation marks and special characters
- touching the «A/a» on-screen button changes to lower case (only Block)

Perfect Stitch Formation

- use the same color for upper and bobbin threads
- use stabilizer on the wrong side to reinforce sewing project
- use additional water soluble stabilizer on the right side on pile and long fiber fabric (e. g. wool, velvet, etc.)
- use simpler letters, programmed with straight stitches (like Double Block lettering)

Combining Lettering

- Stitch: **Letters**
 Needle: **size and type suitable for the fabric selected**
 Thread: **cotton, decorative**
 Feed dog: **up (sewing position)**
 Presser foot: **Reverse pattern foot No. 1**

Alphabets

- individual letters and rows of the same letter of the same alphabet are sewn in Single Mode
- letters for names, addresses, words, etc. are combined and sewn in Combi Mode



Combining Letters

- open Combi Mode
- select desired letter
- letter appears in Stitch Altering Area and on bar above Alphabet menu
- cursor is below the letter



- select next letter and touch required button
- second letter appears in Stitch Altering Area, etc.

Correcting Combinations



Inserting Letters

- a letter is always inserted above the cursor
- cursor must be scrolled up (arrow) to insert an additional letter at the beginning of lettering
- activate desired place by selecting required letter in Stitch Altering Area or scroll to it
- select new letter
- letter is inserted above cursor

Deleting Letters

- a letter is always deleted above the cursor
- activate desired place by selecting required letter in Stitch Altering Area, or scroll to it
- touch «Delete»
- letter is deleted



- saving and deleting combinations







**Adding Securing function
(4 small securing stitches)**

There are different ways to automatically secure stitching:

1. touch function button before starting to sew to secure stitching at the beginning
2. program function within a combination to secure accordingly

Combining Lettering and Functions

Select Lower Case (only Block)

- touch Lower Case/Upper Case button
- the lower case «a» is highlighted in black
- touch Lower Case/Upper Case button again and the capital «A» is black
- Upper Case is reactivated



Mirroring Lettering

- touch «Horizontal Mirror Image (left/right)»
- the letter is mirrored horizontally
- for special effects «Vertical Mirror Image» can be selected



Using Pattern Extend to Stretch Lettering

- touch «Pattern Extend» one time
- selected letter is stretched by 2 times its original size

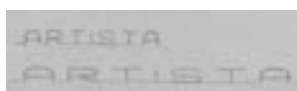

Pattern Combination as Single or Multiple Repeat

- create pattern combination
- touch «Pattern Repeat 1-9x» button one or more times (numbers 1-9 appear)
- sewing computer stops automatically after completing selected number of patterns



Change Size

- touch Alphabet Size button; the field with number 2 is blue
- the letter is reduced to approx. 4mm
- touch «Alphabet Size» again to reactivate the larger size (field with number 1 is blue)

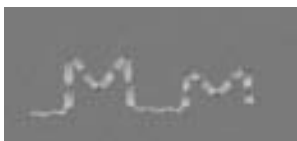

Buttonholes

In General

Buttonholes are practical closures which can also be used for a decorative effect. The artista 630 provides a very versatile selection.

All buttonholes can be sewn and programmed in a variety of ways.



Buttonholes/Button Sew-on Program/Eyelets

- press Buttonhole button
- a summary of the different buttonholes and eyelets appears on the screen display
- touch desired stitch



51 Standard Buttonhole

Light- to mediumweight fabrics. Blouses, dresses, bedding, etc.



52 Narrow buttonhole (heirloom sewing)

Light- to mediumweight fabrics. Blouses, dresses, children's and baby clothes, dolls' clothes, crafts



53 Stretch buttonhole

All stretch fabrics made from cotton, wool, silk and synthetic fibers



54 Round buttonhole with normal bartack

For medium- to heavyweight fabrics of all types. Clothing, jackets, coats, rainwear



56 Keyhole buttonhole with normal bartack

Heavyweight non-stretch fabrics. Jackets, coats, leisure wear



59 Straight stitch buttonhole

For reinforcing buttonholes, pocket edges, especially for stitching buttonholes in leather or imitation leather



60 Button sew-on program

For buttons with 2 and 4 holes



61 Narrow zig-zag eyelet

Opening for cords and narrow ribbons/bands, decorative work

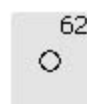

62 Straight stitch eyelet

Opening for cords and narrow ribbons/bands, decorative work

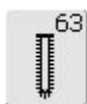

63 Hand-look buttonhole

Light- to mediumweight woven fabrics. Blouses, dresses, leisure wear, bedding

Buttonhole Program Functions

The functions below appear on the function toolbar at the lower edge of the screen display when any buttonhole (Nos. 51–54, 56, 59 and 63) is selected.



Manual Buttonhole

- touch symbol to open special screen display
- sew manual buttonhole in 4 or 6 steps (according to buttonhole type)

Application:

- for individual manually sewn buttonholes
- to repair existing buttonholes



Buttonhole Length – Direct Entry Length (in mm) or On-screen Button Measurement

- touch symbol to open special screen display
- enter the buttonhole length (stitch length in mm) directly with the stitch length or stitch width knob
- to measure hold button to the left side of screen
- determine the buttonhole length by placing the vertical black line precisely on the right side of the button
- 2mm for the button thickness will be added automatically (with on-screen button measurement only)

Application:

- simple method to determine buttonhole size by direct entry of the length in mm or by measuring button on the screen



Programming Buttonhole Length

- the symbol is automatically highlighted in blue (active) when a buttonhole is selected
- using the Quick Reverse button on head frame a buttonhole length can be determined directly, or the displayed length can be programmed directly by touching the symbol



- when the buttonhole is programmed the symbol is turned off (inactive, yellow)
- if a new length is to be programmed the symbol has to be reselected

Buttonholes - Important Information

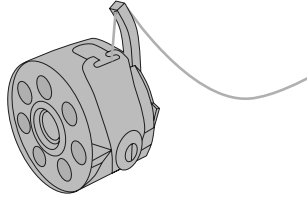

Thread Tension

- thread the bobbin thread through the finger of the bobbin case = the bobbin tension is a little tighter
- this gives the beads on the right side of the fabric a slightly rounded appearance
- the buttonhole looks more attractive
- cord reinforces buttonholes and enhances their appearance
- sew both beads at the same speed

Marking Buttonholes

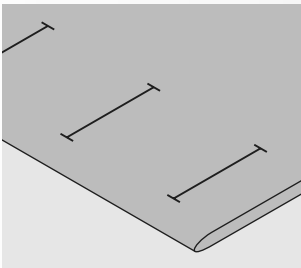

Manual Buttonholes

- mark the buttonhole length in the desired position
- use Buttonhole foot No. 3

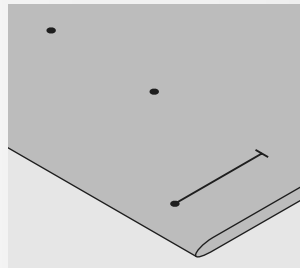

Automatic Buttonholes

- mark the length of just one buttonhole
- after sewing the first buttonhole, the length for all subsequent buttonholes is automatically programmed
- mark only the beginning of all subsequent buttonholes
- use Automatic buttonhole foot No. 3A

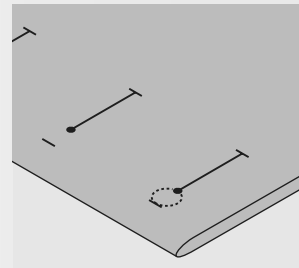

Keyhole Buttonholes

- mark the bead length only
- the correct length eye will be added when the buttonhole is sewn

Test Sewing

- always sew a test sample on the fabric with stabilizer you intend to use
- select the buttonhole type you intend to use
- sew the buttonhole in the same direction on the fabric (with or against the grain)
- cut the buttonhole open
- push the button through
- adjust the buttonhole length if necessary



Corrections

To Adjust the Bead Width:

- alter the stitch width



Altering the Stitch Length:

- any alterations to the stitch length affect both beads (more dense or less dense)
- always reprogram the buttonhole after any changes to the stitch length

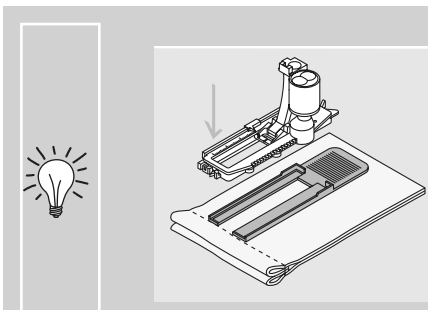
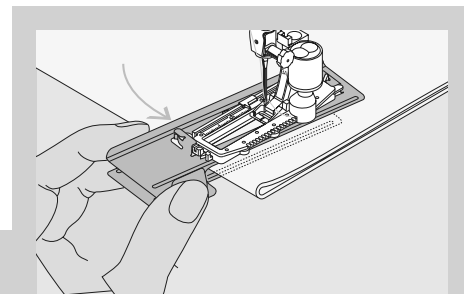

If a buttonhole is to be sewn at right angles to a seam, we recommend the use of the height compensating plates for buttonholes (available as optional accessory). Place the plates from the back between fabric and bottom of slide foot up to the thick part of the fabric and push to front.

Using the compensation plate (in some countries only available as optional accessory) is recommended when sewing buttonholes in difficult fabrics. It can only be used with the Automatic buttonhole foot No. 3A.

Correct Interfacings or Stabilizers for Buttonholes

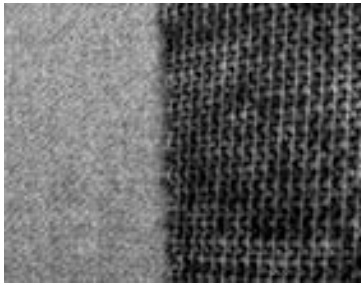

1

Automatic Buttonholes

- for best results always sew buttonholes on area that is lined with interfacing (1)
- the interfacing should suit the fabric type

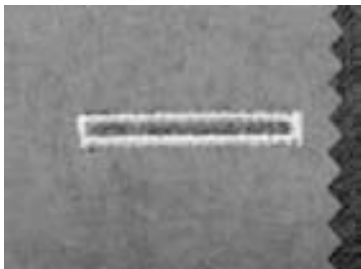

2

- for thick and fluffy fabrics an embroidery stabilizer can be used (2). The fabric feeds better

Buttonholes with Cord

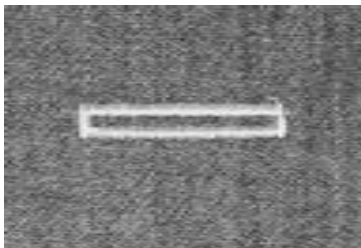

Cord

- use cording to reinforce buttonholes and enhance their appearance
- the loop of the cord should be at the end of the buttonhole most subject to wear
cord loop = where button is sewn on
- position the work accordingly

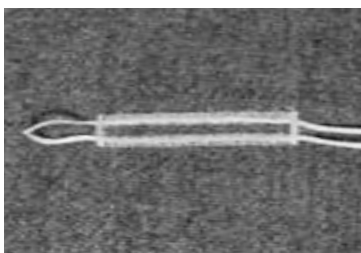

Ideal Cords

- Perle cotton No. 8
- strong hand-sewing thread
- fine crochet yarn

Hooking the Cord onto Presser Foot

No. 3

- insert the needle at the beginning of the buttonhole
- raise the presser foot
- hook the cord over the center pin on the front of the foot

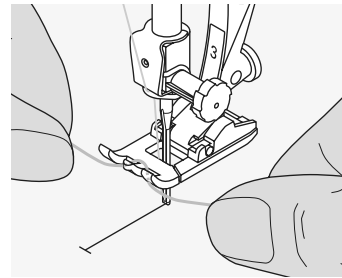

- place both ends of the cord in the grooves on the sole of the foot and pull them to the back
- lower the presser foot

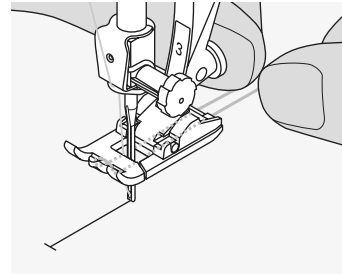

Sewing

- sew the buttonhole in the usual manner, do not hold the cord tightly
- the buttonhole will form over the cord, covering it

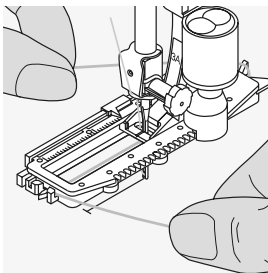

Hooking the Cord in the Automatic Buttonhole Foot with Slide No. 3A

- insert the needle at the beginning of the buttonhole
- raise the presser foot
- guide the cord under the foot to the right
- hook the cord over the pin at the back of the foot

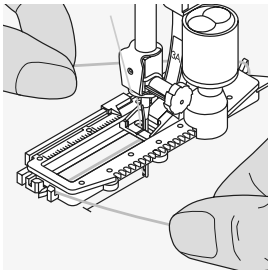

- bring the cords to the front of the foot
- pull them into the slit

Sewing

- sew the buttonhole in the usual manner, do not hold the cord tightly
- the buttonhole will form over the cord, covering it

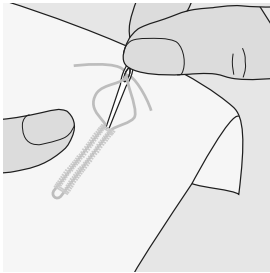

Securing the Cord

- pull the cord through the buttonhole until the loop disappears into the end of it
- pull the ends of the cord through to wrong side of the fabric
- knot or secure with stitches

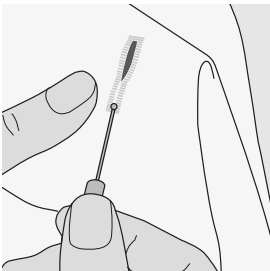

Cutting Buttonholes Open

- using the seam ripper, cut from the ends towards the middle
- in order not to cut the ends of short buttonholes by mistake, place a pin at the end of the buttonhole for additional security

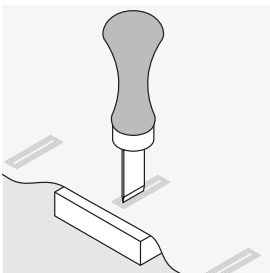

Buttonhole Cutter and Block (special accessory)

- place the fabric on the wood
- place the cutter in the center of the buttonhole
- press down on the cutter with your hand or a hammer

Balance for Buttonholes



Balance for Direct Entry Length Standard Buttonhole

- any Balance alterations affect both beads

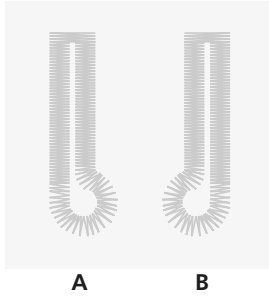

Balance for Direct Entry Length Keyhole or Round Buttonholes

- any Balance alterations affect both beads
- the keyhole or eye is balanced as follows:
 - sew straight stitches until the sewing computer changes to the keyhole or eye, then stop the sewing computer
 - touch «Balance» and now adjust the picture in the right portion of the Balance screen with the stitch length knob to suit the sewn buttonhole



With Direct Entry Length and Manual buttonholes each individual buttonhole sequence can be balanced separately

if keyhole is distorted to the right (picture A):

- turn stitch length knob counter clockwise
- if keyhole is distorted to the left (picture B):
- turn stitch length knob clockwise
 - 3. touch «OK» and complete buttonhole



A



B

Balance for Manual Round or Keyhole Buttonhole

- any Balance alterations affect both beads differently:

if left bead is too dense (picture A)

- turn stitch length knob counter clockwise - left bead will be longer, right bead will be shorter

if left bead not dense enough (picture B)

- turn stitch length knob clockwise - left bead will be shorter, right bead will be longer
- the keyhole or eye is balanced as follows:

if keyhole is distorted to the left (picture B)

- turn stitch length knob counter clockwise
- if keyhole is distorted to the right (picture A)
- turn stitch length knob clockwise

Balance for Manual Standard Buttonhole

- any Balance alterations affect both beads

Recommendation

- sew a test on the fabric(s) you will use



Clear Balance

- touch «Reset» in the special Balance screen or press the «clr» button («clr» deletes the programmed buttonhole as well!)

Automatic Buttonhole

Direct Entry Length or Button Measuring on Screen



- enter the buttonhole length (buttonhole opening in mm) directly with the stitch length or stitch width knob
- suitable for all buttonhole lengths of 4mm up to the maximum length



Entering Buttonhole Length or Button Measuring

- buttonholes can be sewn to a specific length with the Automatic buttonhole foot No. 3A
- select type of buttonhole
- touch the Direct Entry Length function

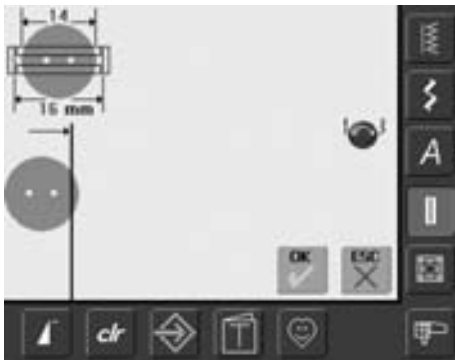

Determining Buttonhole Length

- a special screen display appears
- enter buttonhole length with the stitch width or stitch length knob
- the programmed length (cutting space of buttonhole) is shown underneath the button, between the two arrows
- the number above the button indicates the maximum button size for the selected buttonhole length
- confirm the desired length with «OK», the screen changes automatically
- «auto» and the programmed length in mm appear on the screen
- the buttonhole length indicates the buttonhole opening in mm

Determining Button Size

- a special screen appears
- hold the button against the left side of the screen
- use the external stitch width or stitch length knob place the vertical black line precisely on the right side of the button
- the button size is shown in mm above the button, between the two arrows (e.g. 14mm)
- remove the button from the screen
- confirm the correct size with «OK», the screen changes automatically

Buttonhole Size

- the sewing computer calculates the buttonhole size from the button diameter
- 2mm are added automatically to take the thickness of the button into account

Corrections for Thick Buttons

- for buttons which are particularly thick, e.g. raised buttons, etc. place the vertical line 1 – 4mm outside the button

Corrections for Direct Entry Length

- enter new length as described above

Back to Buttonhole Menu

- touch «ESC» to confirm and return to Buttonhole screen, the original settings remain



Deleting Saved Buttonholes

- press the «clr» button or touch «recording»
- «auto» disappears and «recording» appears
- a new buttonhole length can be programmed

Programming Automatic Buttonholes With Quick Reverse Button on Head Frame



Automatic Buttonhole

- the lens on the Automatic buttonhole foot No. 3A automatically registers the length of the buttonhole (for exact duplication) and automatically completes the buttonhole, when reaching the maximum length
- suitable for all buttonhole lengths of 4mm up to the maximum length, which can be set with stitch width or stitch length knob



Both beads are sewn in the same direction.
The buttonhole length indicates the buttonhole opening in mm.

Sewing Standard and Stretch Buttonholes

No. 51, 52, 53



Sewing First Bead

- the stitching sequence is displayed in the Stitch Altering Area
- sew the first bead forwards, stopping at the required length



Programming Buttonhole

- press the Quick Reverse button on head frame, continue sewing
- «auto» and the programmed length (in mm) appears on the screen to indicate that the buttonhole length is programmed



Auto Buttonhole

the sewing computer sews the following automatically:

- straight stitches in reverse
- the first bartack
- the second bead forwards
- the second bartack
- the securing stitches. The sewing computer stops and automatically changes to the beginning of the buttonhole

All subsequent buttonholes will be sewn automatically to the same length (without pressing the Quick Reverse button)

Sewing Round and Keyhole Buttonholes

No. 54 and No. 56



Sewing Straight Stitches

- the stitching sequence is displayed in the Stitch Altering Area
- sew straight stitches forwards, stopping at the desired length



Programming Buttonhole

- press the Quick Reverse button on head frame, continue sewing
- «auto» and the programmed length (in mm) appear on the screen to indicate that the buttonhole length is programmed



Auto Buttonhole

the sewing computer sews the following automatically:

- the eye or the keyhole
- the first bead in reverse
- straight stitches forwards
- the second bead in reverse
- the bartack
- the securing stitches. The sewing computer stops and changes automatically to the beginning of the buttonhole

All subsequent buttonholes will be sewn automatically to the same length (without pressing the Quick Reverse button)

Double sewn keyhole buttonholes



- keyhole buttonholes can be sewn twice on thick fabrics and the stitches are made longer when sewing the first time
- after sewing the first buttonhole, do not move the work, simply tap the foot control once to begin sewing again

Sewing Hand-look Buttonhole No. 63



Length of the First Bead

- sew bead to desired length
- stop sewing computer



Programming the Buttonhole

- press Quick Reverse button on head frame, continue sewing
- «auto» and the programmed length (in mm) appears on the screen to indicate that the buttonhole length is programmed



Auto Buttonhole

the sewing computer sews the following automatically:

- the eye
- the second bead in reverse
- the bartack, the securing stitches and stops automatically

All subsequent buttonholes will be sewn automatically to the same length (without pressing the Quick Reverse button)



Beautiful buttonholes

- for successful sewing of buttonholes always use a suitable stabilizer or interfacing
- using a cord enhances the appearance of the buttonholes
- keep the speed consistent for each buttonhole (reduce motor speed if necessary). This results in equal density of the buttonhole bead



Important: How to Correct Mistakes

- touch the Pattern Begin function
- the sewing computer reverts to the beginning of the buttonhole



Deleting Saved Buttonholes

- press the «clr» button or touch «recording»
- «auto» disappears and «recording» appears
- a new buttonhole length can be programmed

Buttonhole in Long Term Memory



Long term saving of buttonhole programs is only possible for buttonholes originally stitched as «auto» length buttonholes.

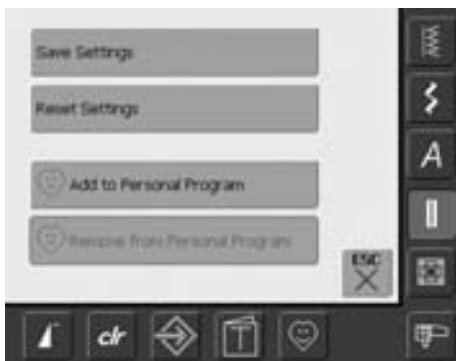

Saving Buttonhole (Save)

- touch the displayed buttonhole in the Stitch Altering Area (left portion of screen)
- a special screen appears
- touch the Save function and the buttonhole is saved in the long term Memory



Recalling Saved Buttonhole

- select the desired buttonhole type
- the buttonhole length appears on the Direct Entry Length on-screen button
- «auto» and the length in mm appear on the screen

Changing Saved Buttonhole

- select the desired buttonhole type
- touch the Direct Entry Length function
- change the length of the saved buttonhole on the screen that appears and confirm with «OK»
- save buttonhole as described above
- programming a new length overrides the existing saved one

Deleting Saved Buttonhole

- select the desired buttonhole type
- touch the Direct Entry Length function and program a new length or touch the displayed buttonhole in the Stitch Altering Area
- a special screen appears
- touch «Reset» and the saved buttonhole is deleted
- a new buttonhole length can be programmed

Manual 4 or 6 Step Buttonholes

Stitch: **any buttonhole**
 Needle: **size and type suitable for the fabric selected**
 Thread: **cotton or polyester**
 Feed dog: **up (sewing position)**
 Presser foot: **Buttonhole foot No. 3**



Opening Manual Buttonhole

- select the type of buttonhole desired
- touch «man» for the Manual buttonhole function



Sewing a 4 Step Buttonhole

- «1» is activated
- sew the first bead
- stop the sewing computer at the desired length
- touch «2» on the screen
- the sewing computer sews the eye or the keyhole
- touch «3»
- the sewing computer sews the second bead in reverse
- stop the sewing computer at the first stitch



Sewing a 6 Step Buttonhole

- «1» is activated
- sew first bead
- stop sewing computer at the desired bead length
- touch «2»
- the sewing computer sews straight stitches in reverse
- stop sewing computer at the first stitch of the first bead
- touch «3»
- the sewing computer sews the top bartack and stops automatically



Leave Program

- touch «ESC» or «man»
- screen reverts to the original Buttonhole screen



Sewing buttonholes manually is ideal if you only need to sew one; also for repairing existing buttonholes.

The number of steps depends on the type of buttonhole.

The standard buttonhole has 6 steps, round, keyhole and hand-look buttonholes have 4 steps.

A manually sewn buttonhole cannot be saved.

- touch «4»
- the sewing computer sews the top bartack and secures stitches automatically
- the length of the beads is determined manually when sewing
- bartack, eye and securing stitches are preprogrammed
- the individual steps can also be selected by pressing the Quick Reverse button

- touch «4»
- the sewing computer sews the second bead
- stop sewing computer
- touch «5»
- the sewing computer sews the bottom bead and stops automatically
- touch «6»
- the sewing computer secures the stitches and stops automatically
- the bead length is determined by the user
- the bartack and the securing stitches are preprogrammed
- the individual steps can also be selected by pressing the Quick Reverse button



Repairing buttonholes

- omit or bypass the unneeded steps
- use only the steps which are necessary to repair the worn sections

Straight Stitch Buttonhole

| | |
|---------------|---|
| Stitch: | Straight stitch buttonhole No. 59 |
| Needle: | size and type suitable for the fabric selected |
| Thread: | cotton or polyester |
| Feed dog: | up (sewing position) |
| Presser foot: | Buttonhol foot No. 3 or Automatic buttonhole foot No. 3A |



Straight Stitch

- select stitch No. 59 on the screen
- it is programmed the same way as the Automatic Buttonhole Program (see page 69, 70)

Altering the Distance Between the Rows of Stitching

- alter the stitch width if the distance between the two rows of stitching is too wide or too narrow



Straight stitched buttonholes are particularly useful for reinforcing buttonholes on all soft and loosely woven fabrics such as wool, or for buttonholes which are subject to extreme wear. They are also useful for reinforcing buttonhole openings in leather, vinyl or felt.

Button Sew-on Program

| | |
|---------------|---|
| Stitch: | Button sew-on program No. 60 |
| Stitch width: | depends on the distance between the holes |
| Needle: | size and type suitable for the fabric selected |
| Thread: | cotton or polyester |
| Feed dog: | down (darning position) |
| Presser foot: | Darning foot No. 9 or Button sew-on foot No. 18 (optional accessory) |



Button Sew-on Program

- select stitch No. 60 on the screen

Sewing 2 Hole Button

- check distance between holes with the handwheel and adjust stitch width if necessary
- hold the threads when starting to sew
- sew on button
- the sewing computer stops automatically when program is completed and is immediately ready for the next button



Buttons with 2 and 4 holes can be attached. The shank (thread length between button and fabric) can be made shorter or longer (foot No. 18) as desired. Buttons sewn on for decorative purposes only are stitched without a thread shank.

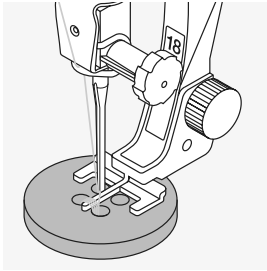

Sewing 4 Hole Button

- sew the front holes first
- carefully move the button forward
- sew the back holes with the same program

Beginning and Ending Threads

- the threads are secured and can be trimmed

For Secure Results

- pull both bobbin threads until the ends of the upper thread are visible on the wrong side (knot if required)
- trim threads

Sewing on buttons

A real time saver, especially when several of the same type buttons must be sewn on, e.g. blouses, bedding, etc.



For work which is subject to heavy wear or washing, sew Button sew-on program twice.

Zig-zag or Straight Stitch Eyelets

Stitch: **Narrow zig-zag eyelet No. 61 or
Straight stitch eyelet No. 62**

Needle: **size and type suitable for the fabric selected**

Thread: **cotton or polyester**

Feed dog: **up (sewing position)**

Presser foot: **Reverse pattern foot No. 1**



Eyelet Programs

- select desired eyelet
No. 61 = zig-zag eyelet
No. 62 = straight stitch eyelet

Sewing Eyelets

- position fabric under the presser foot and sew
- the sewing computer stops automatically when finished and is immediately ready for the next eyelet

Punching Eyelets

- use an awl or punch to cut open the eyelet

Eyelets are ideal openings for cords and narrow ribbons, attractive decorative elements, ideal for children's clothing, and crafts. They cannot be programmed in stitch combinations.

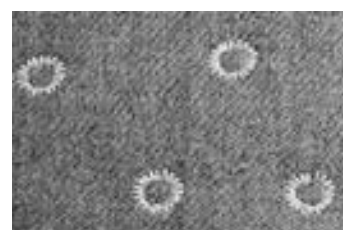
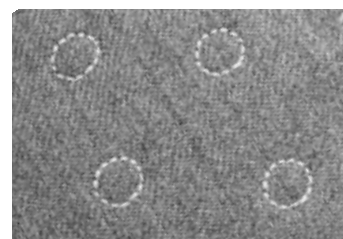

Quilt Stitches

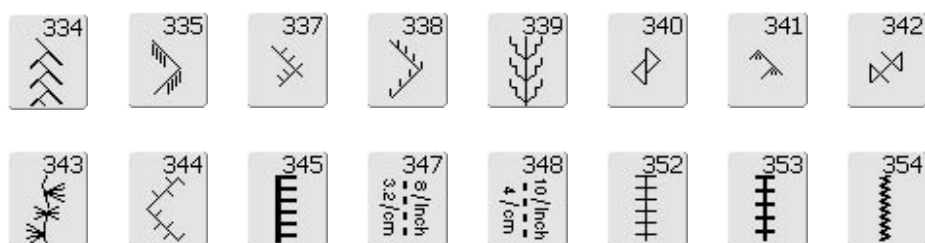

Quilt Stitches

Different stitches can be selected which can be used especially for quilting, patchwork or for appliqué:

| | |
|---------------|--|
| No. 324 | Quilters securing program |
| No. 325 | Quilting straight stitch |
| No. 327 | Stippling stitch |
| No. 328 | Hand-look quilt stitch |
| No. 329 | Blanket stitch |
| No. 330 | Double blanket stitch |
| No. 331 | Blindstitch |
| No. 332 | Feather stitch |
| No. 333 - 338 | Feather stitch variations |
| No. 339 - 345 | Decorative quilt stitches |
| No. 347, 348 | Quilt stitch / Hand-look quilt stitch variations |
| No. 352 | Blanket stitch (dual) |
| No. 353 | Double blanket stitch (dual) |
| No. 354 | Satin stitch |

- touch the stitch of your choice
- the stitch is activated
- all information on-screen is visible
- stitch widths/stitch lengths can be altered and customized

Important Information on Different Techniques

Patchwork, Appliqué and Quilting

Patchwork

- with this technique fabric of different colors, forms and patterns are sewn together to make blankets, wall hangings and garments
- for the design of patchwork basic geometric forms are most suitable, e.g. different rectangular and triangular forms as well as squares

Stitch for patchwork:

- No. 325 Straight stitch (shortened stitch length)



Appliqué

- to appliqué is to apply patches of fabric by sewing or embroidering on the base fabric
- apart from creative and artistic designing the appliqué technique also makes it possible to cover damaged areas in a clever way

Following stitches can be used:

- No. 354 Satin stitch
- No. 329, 330, 352, 353 Blanket stitches
- No. 331 Blindstitch



Quilting

Quilts consist of three layers:

- decorative top layer of fabric (usually patchwork)
- middle layer - batting
- bottom layer in plain fabric used as lining

After these three layers, which result in a «quilt sandwich», have been pinned and basted they are sewn together with different stitches. This is called quilting.

Following stitches are suitable for quilting:

- Nr. 324 Quilters securing program
- Nr. 325 Quilting straight stitch
- Nr. 328, 347, 348 Hand-look quilt stitches
- Nr. 327, 331 - 345 Decorative quilt stitches

- freehand quilting with or without BSR (optional accessory)



Hand-look Quilt Stitch

Stitch: **Quilt stitches Nos. 328, 347 and 348**
 Needle: **size and type suitable for the fabric selected**
 Upper thread: **monofilament**
 Bobbin thread: **30/2 cotton thread**
 Feed dog: **up (sewing position)**
 Presser foot: **Reverse pattern foot No. 1 or Walking foot No. 50 (optional accessory)**

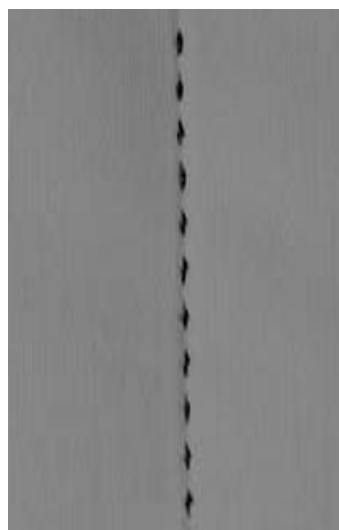

Hand-look Quilt Stitch

- Suitable for all fabrics and work which should look «hand sewn».

Sewing Test

- the bobbin thread is pulled to the right side 1 stitch is visible (bobbin thread) 1 stitch is invisible (monofilament) = hand-look effect

Upper Thread Tension

- depending on the fabric = increase the tension (6–9)

Balance

- adjust stitch with the Balance if necessary

Perfect corners

- activate Pattern end and Needle stop down and pivot the work
- when pivoting make sure that the fabric does not become distorted



Monofilament breaks

- sew more slowly
- reduce upper thread tension slightly

Sewing

- the hand-look quilt stitch can be sewn in any needle position

Freehand Quilting

Stitch: **Straight stitch No. 1**
 Needle: **size and type suitable for the fabric selected**
 Thread: **monofilament or cotton**
 feed dog: **down (darning position)**
 Presser foot: **Darning foot No. 9 or Quilting foot No. 29 (optional accessory)**



Freehand Quilting

- for all freehand quilt work

Preparation

- pin and baste top layer, batting, and lining together
- attach the slide-on table

Holding the Work

- hold the fabric with both hands like an embroidery frame
- start in the center and work out toward the edges

Quilting a Design

- turn the work using smooth, round movements to form the design of your choice

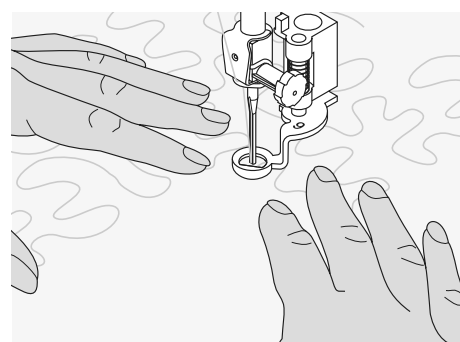

Stipple Quilting

- technique covers the entire surface of the fabric
- the lines of stitching are rounded without any sharp corners; they never cross nor touch one another

Freehand Quilting With BSR (BERNINA Stitch Regulator) optional

Stitch: **Straight stitch No. 1 or Zig-zag stitch No. 2**
 Needle: **size and type suitable for the fabric selected**
 Thread: **monofilament or cotton, embroidery thread, polyester**
 Feed dog: **down (darning position)**
 Presser foot: **BSR foot No. 42 incl. interchangeable soles (closed, open, transparent)**



BSR (BERNINA Stitch Regulator) Function

The BSR presser foot reacts to the movement of the fabric under the foot and controls the speed of the sewing computer up to the maximum speed possible. The following applies: the faster the fabric is moved the higher the speed of the sewing computer. If the fabric is moved too fast an acoustic signal (beep) is heard. The beeper can be turned on or off in the Setup Program or directly on the «BSR» screen.

BSR Function With Straight Stitch No. 1

This function using a special presser foot allows for free-motion quilting (sewing) using the straight stitch and a pre-selected stitch length (up to 5mm).

A regulated set stitch length is maintained within a certain speed, independent of the movement of the fabric.

BSR Function With Zig-zag Stitch No. 2

The zig-zag stitch can be used for thread painting or fabric embellishment.

The set stitch length will **NOT** be maintained when sewing with the zig-zag stitch, but the BSR function simplifies the application.

Warning!

By activating the BSR function the sewing computer sews either continuously at a reduced motor speed (mode 1, standard), or as soon as the fabric is moved (mode 2).

As long as the BSR presser foot is illuminated red, adjustments like threading and changing the needle, for example must not be carried out, as the needle will engage while fabric is moved unintentionally!

Without fabric feed the BSR mode is turned off after approx. 7 seconds and the red light goes off.

Please refer to the Safety Instructions!

BSR function can be sewn in 2 separate modes of operation:

BSR 1

- BSR mode 1 is the active standard
- the sewing computer runs continuously at a reduced motor speed, as soon as the foot control or the Start-Stop-button is pressed
- moving the fabric under the foot will engage the sewing computer to accelerate
- through the continuous needle movement securing in the same position is possible without pressing an additional button

BSR 2

- touch the button «BSR2» to engage BSR mode 2
- the sewing computer will only engage if the foot control or the Start-Stop-button is pressed and the fabric is moved **simultaneously**
- the movement of the fabric determines the sewing speed
- for securing, the «Securing Function» button must be pressed
- touch the button «BSR1» to engage BSR mode 1

For an even sewing start (one single stitch) the foot control must be pressed and the fabric moved **simultaneously**.

This also applies for sewing points and straight stitching within a round form.

If the BSR function is deactivated and later re-activated without the sewing computer being switched off in between, the last selected BSR mode is active.

Preparation

- lower the feed dog
- the presser foot pressure must be reduced to minimum
- use slide-on table

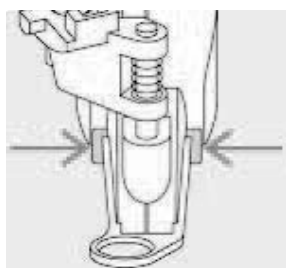

- attach the desired presser foot sole to the BSR presser foot
 - removing sole: press both buttons (see arrows) on each side of the foot
 - slide the sole down the groove at an angle
 - attaching the sole: slide the sole up in the groove until it clicks into place

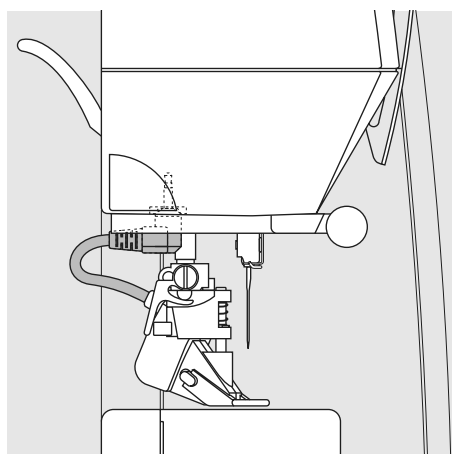

- attach the BSR presser foot to the sewing computer and plug the cable into the green socket until it clicks into place



- the «BSR» screen opens automatically
- the BSR mode 1 is activated (BSR1 is standard)
- the basic stitch length setting is 2mm
- set the desired stitch length
- when sewing small forms and stippling, stitch length of 1mm - 1.5mm is suggested

Using the following functions in the BSR mode:

Needle Stop Down (Default)

- the arrow points down on the display = the sewing computer stops with needle down, when taking foot off foot control or the Start-Stop-button

Needle Stop Up

- press the needle stop button until the arrow points up = the sewing computer stops with needle up, when taking foot off foot control or the Start-Stop-button

Raise or Lower the Needle

- press the needle stop button - or by pressing the heel on the foot control, the needle can be lowered or raised

Securing With the Start-Stop-Button (only Mode 1)

- unplug the foot control
- place the fabric under the presser foot, lower presser foot
- press the Needle Stop button twice to bring up the lower thread
- hold upper and lower thread and start the BSR mode by pressing the Start-Stop-button
- sew 5 to 6 securing stitches
- stop the BSR mode by pressing the Start-Stop-button
- cut threads
- re-start the BSR mode by pressing the Start-Stop-button to continue the stitching process

Securing Function (only Mode 2)

- press the «Securing Function» button
- press the foot control / Start-Stop-button 
- short securing stitch sequence will be sewn as soon as the fabric is moved under the presser foot. After the sequence is sewn the set stitch length will be activated and the securing function will be automatically deactivated

Free Hand Quilting

- the BSR mode is activated
- free hand quilting can be sewn
- when the securing function button is pressed during free hand quilting, a short securing stitch sequence will be sewn and the sewing computer will stop sewing automatically
- the BSR mode is deactivated

Free Hand Quilting Without BSR Activation

- touch the BSR button (on the left side on the display)
- the BSR mode is deactivated, the buttons «BSR1» and «BSR2» on the left side on the display go off
- normal free hand quilting **can now be sewn with the BSR foot, without automatic regular stitch length**



When exceeding a certain speed, adhering to regular stitch length cannot be guaranteed.

Make sure that the lens on the bottom of the BSR foot is not dirty (fingerprints, etc.). Clean lens periodically with soft, slightly damp cloth.

Beeper (Acoustic Signal) Deactivation/Activation

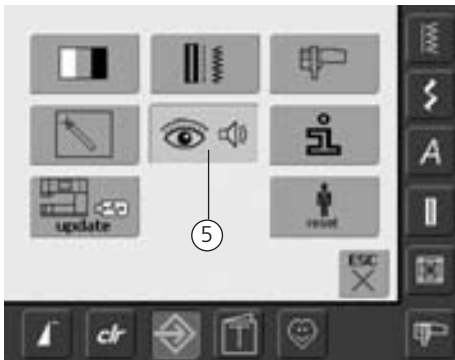

Opening Setup Program

- press the Setup button
- selection menu appears
- touch «5»
- the screen «Audio Settings» appears



Selecting Sound for BSR in the Setup Program

- one sound is set as default
- touch the bar with the speaker symbol for BSR one time
- if the bar is gray and the speaker is red, the sound for the beeper is inactive
- if the sounds in the Setup Program are generally turned off (big bar on left side of screen is gray, speaker is red), the symbol with the speaker of the «BSR» bar is not visible



Selecting Sound for BSR ion the «BSR» Screen

- one sound is set as default
- touch the bar with the speaker symbol for BSR one time
- if the bar is gray and the speaker is red, the sound for the beeper is inactive



generally, the sound selection symbol is only visible if the sounds are turned on in the Setup Program

Activating/Deactivating the BSR Sewing Function:

1. With the Foot Control

- plug in the foot control
- lower the presser foot
- start the BSR mode by pressing the foot control
- a red light appears on the presser foot
- the foot control must be pressed continuously during sewing
- the speed of the sewing computer will be regulated by the movement of the fabric
- by releasing the foot control the BSR mode will be stopped

2. With the Start - Stop - Button

- remove the foot control
- lower the presser foot
- start the BSR mode by pressing the Start-Stop-button
- a red light appears on the presser foot
- the speed of the sewing computer will be regulated by the movement of the fabric
- by re-pressing the Start-Stop-button the BSR mode will be stopped

Deactivating the BSR Sewing Function by using the Start - Stop - Button:

Mode 1:

- if the fabric is not moved for approx. 7 seconds, the BSR mode will be deactivated and the red light on the presser foot goes off

Mode 2:

- if the stitching process is ended by no longer moving the fabric, one additional stitch is made depending on the needle position. The sewing computer **always** stops with the needle up, even if the arrow on the display points down



Holding the Work

- hold and guide the taut fabric with both hands
- abrupt movements of the fabric (slowing down, speeding up respectively) can result in slightly too short or too long stitches
- **continuous movement of the fabric (no abrupt movements) under the foot will provide best results**
- move the fabric in one direction for best results



Application Example:

BSR With Zig-zag Stitch No. 2

- the zig-zag stitch can be used for thread painting or fabric embellishment for example
- areas can be filled and forms or pictures created

BSR Function Deactivation

- pull out the plug of the BSR presser foot connection cable on the sewing computer. The previously selected stitch is active again
- remove the BSR foot

Programming Screen With Personal Stitches

Use the Personal Program to design a screen with the stitches you use most.

Whether it is made up of stitches for a certain type of sewing, such as heirloom or garment, or just your favorite practical and decorative stitches or alphabets, this screen will make it easy and quick to sew any project.

When inserting stitches into the Personal Program, variations of all stitches may be entered into the Personal Screen.

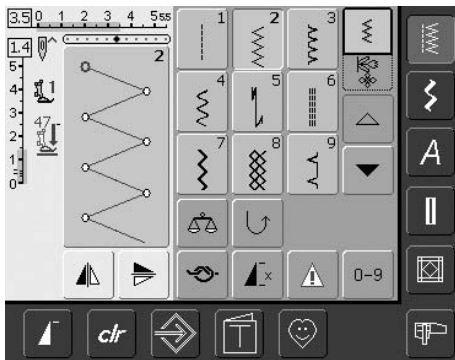

Programming First Stitch

- select the zig-zag from the Practical Stitch Menu (referred to on other pages as a menu), make any desired alterations to the stitch settings
- touch the Stitch Altering Area (light blue)

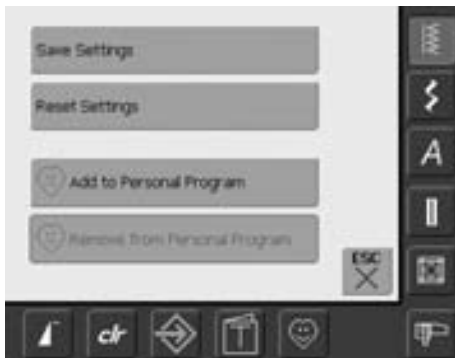

- a special screen appears
- touch the bar «Add to Personal Program»
- the zig-zag stitch is saved in the Personal Program (including any alterations), the screen closes
- changes can be deleted again by touching the «clr»



Programming Second Stitch

- press the Buttonhole button
- select Standard buttonhole (No. 51)
- touch the Stitch Altering Area (light blue)
- save the stitch as described above
- insert further stitches in the same manner

Following alterations may be entered:

- stitch width
- stitch length
- Needle Position
- Mirror Image
- Pattern Extend
- Balance
- Pattern Repeat 1–9



If the Memory is filled with embroidery designs or stitch combinations, stitches cannot be saved in the Personal Program. A message will appear to this effect. Embroidery designs and/or stitch combinations must first be deleted.

Selecting Stitches in Personal Program



Activating Personal Program

- press the Personal Program button



Personal Screen

- in the personal screen the programmed stitches are visible (progressive stitch numbers)
- when more than 9 stitches are programmed, use arrow to scroll for viewing additional stitches

Deleting Personal Stitches



Activating Personal Program

- press the Personal Program button

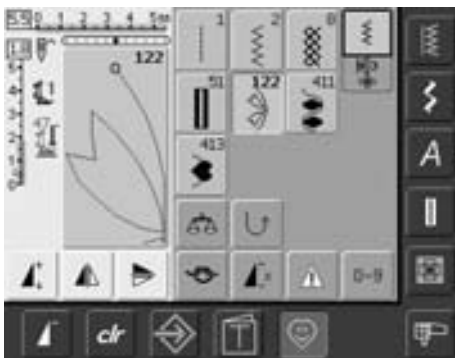

Personal Program Screen

- select the stitch to be deleted
- touch the Stitch Altering Area (light blue)

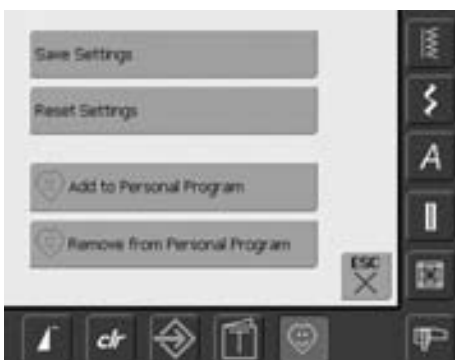

- a special screen appears
- touch the bar «Remove from Personal Program»



Stitch Deleted

- the special screen closes
- the selected stitch is deleted, all remaining stitches will move along to fill the space

Altering Stitches



Activating Personal Program

- press the Personal Program button

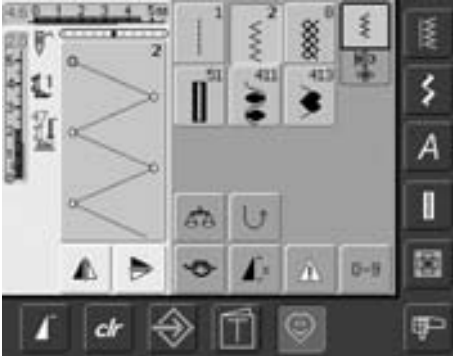

Personal Program Screen

- select the stitch to be altered (e.g. zig-zag)
- alter stitch width and length with the external stitch width and stitch length knobs
- the alterations as well as the basic settings are indicated
- touch the Stitch Altering Area (light blue)

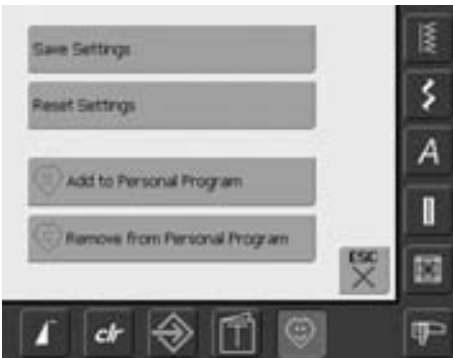

- a special screen appears
- touch the bar «Save Settings» and all alterations are saved, the special screen closes



Special Screen

- «Save Settings»: all alterations (stitch length and width, etc.) of the selected stitch are saved
- «Reset Settings»: all alterations of the selected stitch are reset to basic settings
- «Add to Personal Program»: a selected stitch (with possible alterations) is saved in the Personal Program
- «Remove from Personal Program»: a selected stitch is deleted from the Personal Program
- touch «ESC» – the screen closes without anything being saved



The possible alterations of the original stitch setting can also be altered permanently in each category.

Saving and Deleting Stitches and Stitch Combinations

In General

Stitches, letters, and numbers can be combined and stored in the memory system. The sewing computer has a memory system, in which the two memories – sewing and embroidery – can be stored. In the sewing memory stitch combinations with maximum 50 stitches can be stored in the Drawers as long as there is free storage space (capacity) available. It may well be, however, that not all Drawers can be filled, due to the saving of many stitches or stitch combinations.

The memory is a long term memory, i.e. the contents remain in it until deliberately deleted. A power cut, or switching off («0») the sewing computer do not affect the saved program.

Programming and Saving Stitch Combinations



- select Combi Mode
- the Stitch Altering Area appears with its functions
- select desired stitch
- alter stitch length, stitch width, needle position or functions such as mirroring, etc. if necessary
- select further stitches

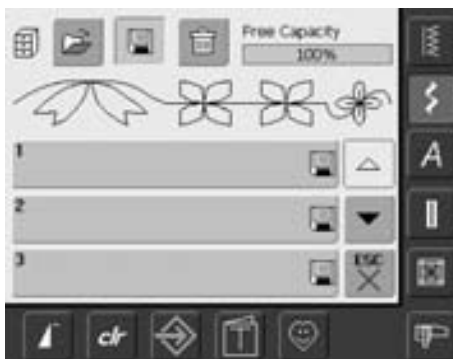

- touch the blinking File Drawers button
- the function «Save» is activated (light blue)
- the System Memory Capacity (Free Capacity) is shown in percentage (%) in a bar top right

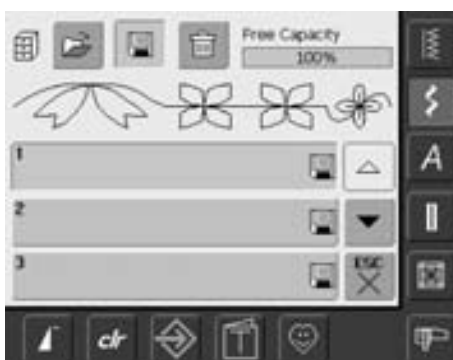

- select the Drawer where you wish to save the stitch combination

Programming and Saving Stitches by Number



- select Combi Mode
- touch «0-9» button
- enter number of desired stitch
- touch arrow to delete individual numbers
- touch field above the numeric pad to delete all numbers
- to confirm and to select further stitches by number touch «OK»

- touch «ESC» if selection is complete
- touch the blinking File Drawers button
- select the Drawer where you wish to save the stitch combination

Empty Stitch Altering Area

- if the Combi Mode has already been in use and the sewing computer has not been switched off («0») since, the last programmed or selected stitch combination appears in the Stitch Altering Area
- empty the Stitch Altering Area by deleting the combination or open an empty Drawer to program a new combination



This procedure does not affect stitch combinations already saved, which remain intact.



Emptying the Stitch Altering Area in Steps

- the stitch above the cursor is deleted
- touch the Delete function until the Stitch Altering Area is empty



Emptying the Stitch Altering Area in a Single Step

- touch the Multifunction button
- touch «Delete»
- touch «OK» to confirm the message
- the Stitch Altering Area is now empty, and a new stitch combination can be programmed

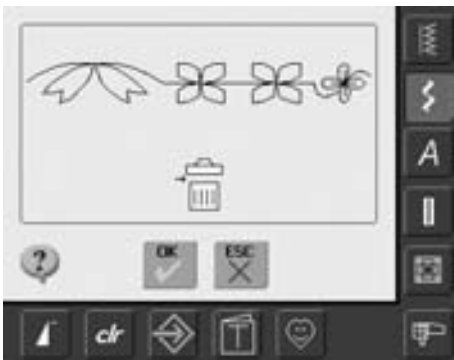

Opening Empty Drawer

- touch the «File Drawers»
- Drawers screen appears
- touch «Open» in the top row
- select an empty Drawer
- the System Memory Capacity (Free Capacity) is shown in percentage (%) in a bar top right

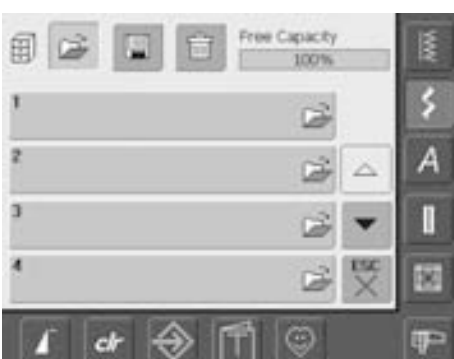



- the Stitch Altering Area is now empty, and a new stitch combination can be programmed
- if desired, save the stitch combination

Drawer Content at a Glance

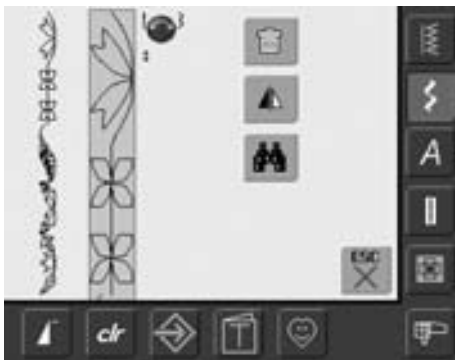

- program a stitch combination
- the corresponding stitch combination is visible in the Stitch Altering Area
- touch the Multifunction button
- the following is displayed on the screen:
- the complete stitch combination on the left
- next to it is the stitch combination in a given size; use the stitch width or the stitch length knob to scroll through the stitch combination
- on the right are the three buttons «Delete Combination», «Mirror Combination» and «Preview»
- touch «ESC» to close the screen

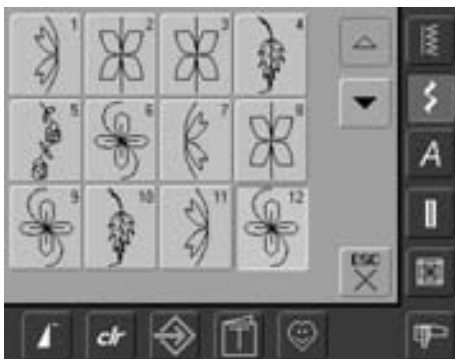

- select «Preview»
- the stitch combination is displayed on screen
- each stitch can be selected directly, e.g. to alter it:
- select stitch, SAA appears automatically to alter selected stitch
- use the arrows to scroll through the stitch combinations
- touch «ESC» to close the Preview screen

Opening Saved Combination



Opening a Saved Combination

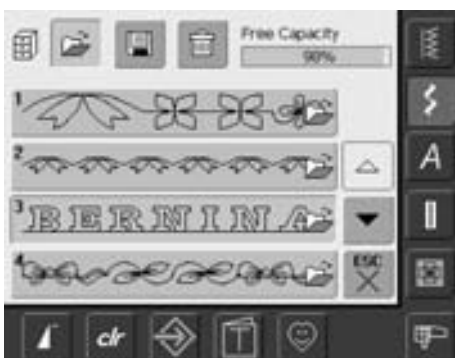

- touch «File Drawers»
- a summary of the saved combinations appears
- scroll to the desired Drawer if necessary
- touch the desired Drawer
- the saved combination appears in the Stitch Altering Area

Correcting a Stitch Combination



Deleting the Stitch Last Programmed

- touch «Delete»
- the stitch last entered is deleted



All alterations always affect the area above the cursor.



Deleting a Stitch Within the Combination

- use the scroll arrows to move the cursor below the stitch to be deleted, or select the stitch directly
- touch «Delete»
- the stitch above the cursor is deleted
- the stitches are automatically recombined



Inserting Stitches

- to activate the desired place, scroll the cursor or select appropriate stitch directly
- select new stitch
- the new stitch is inserted after the selected stitch



- to insert a stitch at the very beginning of a combination, move the cursor right to the top using the scroll arrow
- select new stitch
- the new stitch is inserted above the cursor



Altering Stitch Combinations

- to activate the desired place, scroll the cursor or select the appropriate stitch directly
- select desired function (e.g. mirroring)



Already saved stitch combinations can be altered or corrected in the same way. To save corrections and alterations permanently, the combination must be resaved afterwards.



Mirroring Entire Combinations

- touch Multifunction button
- touch «Mirror Image»
- the entire combination is mirrored horizontally (left/right)



Deleting Drawer

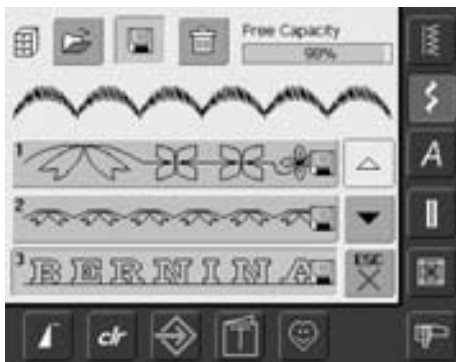

Option 1: Overwriting

- program new stitch combination
- touch the button «File Drawers»
- select the Drawer you wish to overwrite
- confirm the query with «OK»
- the new stitch combination is now saved in this Drawer



Option 2: Deleting

- touch the button «File Drawers»
- saved combinations appear
- touch «Delete»
- select the Drawers which should be deleted
- confirm the appearing query with «OK»; deleting will be stopped by touching «ESC»
- the selected Drawers are empty
- touch «ESC» to close Drawers screen



Setup

The Setup Program allows you to personalize the touch screen to suit your own requirements and preferences. For example, you can adjust the maximum sewing and embroidery speed.

After setting the sewing computer to your personal requirements all changes made in the Setup Program will be saved, even when the sewing computer is turned off («0»).

The sewing computer can be reset and returned to the factory settings at any time.



Opening Setup Program

- press the Setup button
- menu with Setup options appears

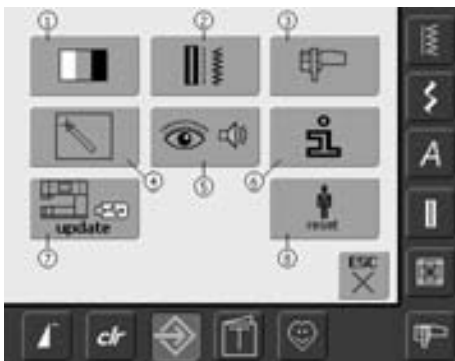

Menu

- the menu lists all features in the sewing computer which can be altered to suit your requirements:
 - 1 Display (screen) Settings
 - 2 Sewing Settings
 - 3 Embroidery Settings
 - 4 Display (screen) Calibration
 - 5 Display Messages and Sounds
 - 6 Information
 - 7 Update the sewing computer
 - 8 Reset to Factory
- the customized alterations remain saved even when the sewing computer is turned off («0»)
- the alterations can be reprogrammed at any time



Leaving Setup Program

- touch «ESC»
- the Setup Program closes
- returns to previous screen



To Next Page

- touch «To Next Page»
- the next screen appears



To Previous Page

- touch «To Previous Page»
- the previous screen appears



Saving and Closing

- touch «OK»
- changes are saved, the screen closes and the selection menu appears



Closing Screen

- touch «ESC»
- the screen display closes, the original settings remain saved and the selection menu appears

Display



Opening Setup Program

- press the Setup button
- selection menu appears
- touch «1»
- in the now opened screen the Display Settings can be changed

Display Settings

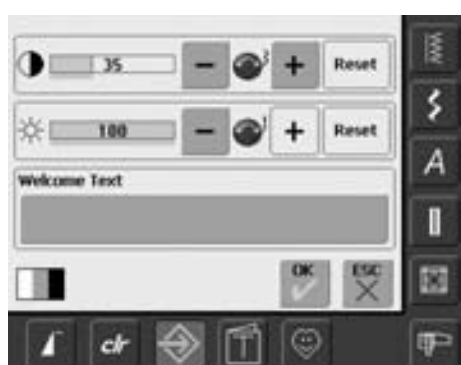

Contrast

- turn stitch width knob or touch «+» or «-»
- the contrast of the screen changes
- the changes are indicated by the number in the bar and the blue background of the «+» and «-»
- the basic settings are indicated by a dark bar

Brightness

- turn stitch length knob or touch «+» or «-»
- the brightness of the screen changes
- the changes are indicated by the number in the bar and the blue background of the «+» and «-»
- the basic settings are indicated by a dark bar
- the «Reset» on-screen button returns you to the basic settings

Welcome Screen

- touch Text bar
- a screen with a keyboard appears



Saving and Closing

- touch «OK»
- changes are saved, the screen closes and the selection menu appears



Closing Screen

- touch «ESC»
- the screen display closes, the original settings remain saved and the selection menu appears



Text in Welcome Screen

- text for the Welcome screen can be written
- the «ABC» on-screen button (upper case) is automatically active (blue)
- the «abc» on-screen button changes to lower case
- the «Ä Å Á», «ä à á» and «@ #» on-screen buttons activate special characters in the upper and lower case
- «1,2,3» activates numbers and mathematical characters
- the bar below the keyboard is a space bar and produces spaces between the words or letters

- the programmed text appears in the Text bar above the keyboard
- by touching this Text bar the programmed text will be completely deleted
- by touching the arrow on the right of the Text bar, entered text is deleted from right to left
- touch «ok» to accept changes

Sewing Settings

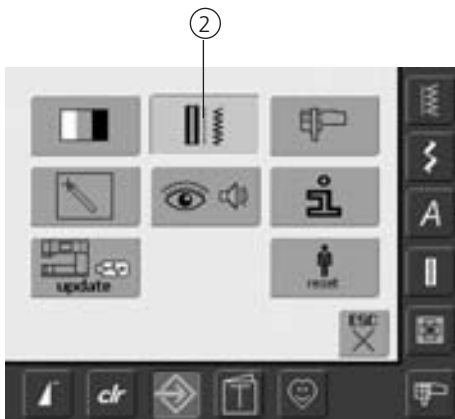

Opening Setup Program

- press the Setup button
- selection menu appears
- touch «2»
- the screen «Sewing Settings» appears

Sewing Settings



Motor Speed

- turning stitch width knob or touching «+» or «-» changes the maximum speed. It increases or reduces the speed by 8-10 stitches
- the number in the bar reflects the stitches per minute, the basic settings are indicated by a dark bar

Embroidery Settings

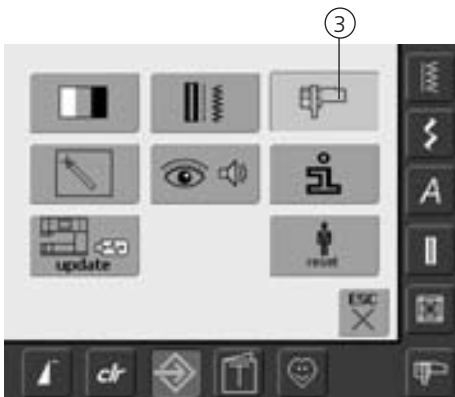

Opening Setup Program

- press the Setup button
- selection menu appears
- touch «3»
- the screen for adjusting the embroidery hoop appears



To Next Page

- touch «To Next Page»
- the next screen appears



To Previous Page

- touch «To Previous Page»
- the previous screen appears



Saving and Closing

- touch «OK»
- changes are saved, the screen closes and the selection menu appears



Closing Screen

- touch «ESC»
- the screen display closes, the original settings remain saved and the selection menu appears

Embroidery Settings 1

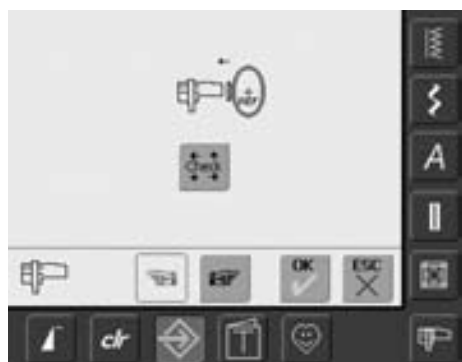

«Adjust Reference Position» calibrates the needle to the center of the embroidery hoop. Adjusting can only be activated if the embroidery module and the oval embroidery hoop are attached. It is only necessary to adjust the Reference Position once as the same setting changes will apply to all the hoops.

- insert the embroidery template into the hoop
- touch «Check»
- the display changes
- the hoop position is read and the needle positioned in the middle
- if the needle is now not positioned exactly over the center point of the template, it has to be adjusted with the arrows
- touch «OK»
- the adjustment will be saved, the display closes and the selection menu appears

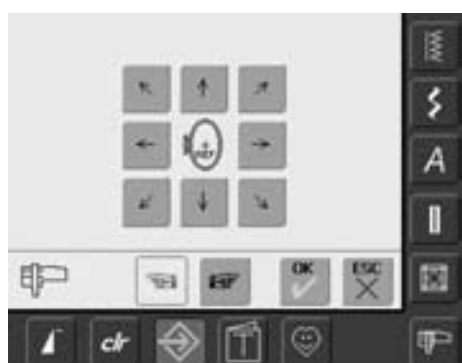

Embroidery Settings 2



- touch «To Next Page»
- in this screen the embroidery speed can be adjusted

Motor Speed

- turning stitch width knob or touching «+» or «-» changes the basic settings of the speed by 6-10 stitches
- the number in the bar reflects the stitches per minute, the basic settings are indicated by a dark bar

Touch (Screen Sensibility)



Opening Setup Program

- press the Setup button
- selection menu appears
- touch «4»
- the screen for calibrating the touch sensitivity of the screen appears

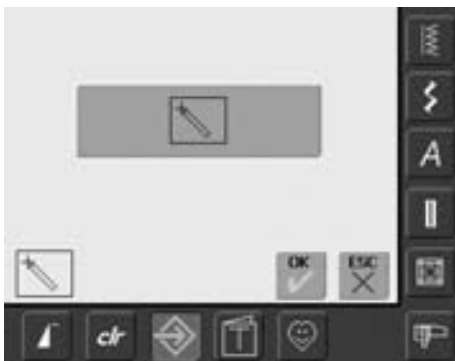

Touch Setup

- touch the Calibration symbol
- a further screen display appears

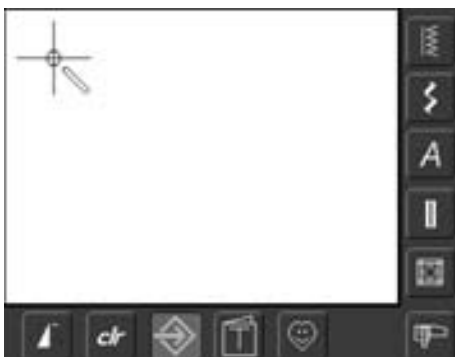

Touch 2

Press and hold stylus on the center of the target. The target will move. Repeat this process until all three positions are calibrated and the screen change back to the original screen. Save the settings with «OK».



Saving and Closing

- touch «OK»
- changes are saved, the screen closes and the selection menu appears



Closing Screen

- touch «ESC»
- the screen display closes, the original settings remain saved and the selection menu appears

Display Messages and Audio Settings

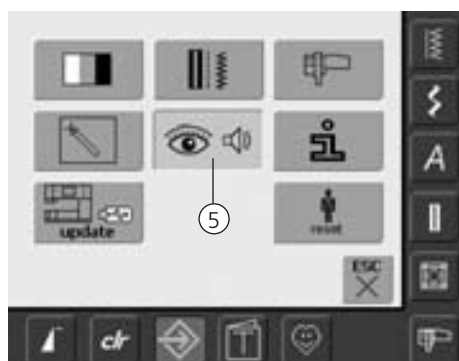

Opening Setup Program

- press the Setup button
- selection menu appears
- touch «5»
- the screen «Audio Settings» appears

Audio Settings



Audio System

- with large left bar the sounds can be activated or deactivated
- blue background and blue speaker means that the bar is active
- gray background and red speaker means that the bar is inactive

Selecting Stitch / Selecting Function / BSR

- the selection of stitches and functions can be indicated acoustically
- for Stiches (top) touch the bar with the speaker symbol one or more times
- one to six sound choices will be activated. The bar is blue and the choice of the selected sound is indicated by a number (1-6). The sounds can be heard
- if the bar is gray and the speaker red, the sounds for the stiches are inactive
- the sounds for Functions (middle) and one sound for Quilting with BSR (bottom) can be turned on and off the same way
- touch «To Next Page»



To Next Page

- touch «To Next Page»
- the next screen appears



To Previous Page

- touch «To Previous Page»
- the previous page appears



Saving and Closing

- touch «OK»
- changes are saved, the screen closes and the selection menu appears



Closing Screen

- touch «ESC»
- the screen display closes, the original settings remain saved and the selection menu appears

Display Messages / Monitoring Functions



- the screen «Display Messages and Monitoring Functions» appears
- following display messages and monitoring functions can be turned on or off:
 - Upper Thread Control
 - Presser Foot Position
- if the bar is blue and the eye open, the message and function are turned on
- if the bar is gray and the eye closed, the message and function are turned off
- the choice of sound is the same as for the other functions and can be turned on or off on the screen «Audio Settings»
- the messages/monitoring functions and choice of sound can be turned on or off independently (i.e. a message/function can be turned on without any acoustic sound)

Information

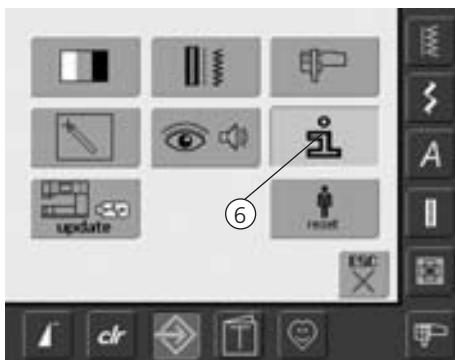

Opening Setup Program

- press the Setup button
- selection menu appears
- touch «6»
- the screen «Language Information» appears with the option to change the language



Language

- there is a choice of several languages
- scroll through the languages by touching the arrows
- the active language is displayed in blue
- touch «To Next Page»

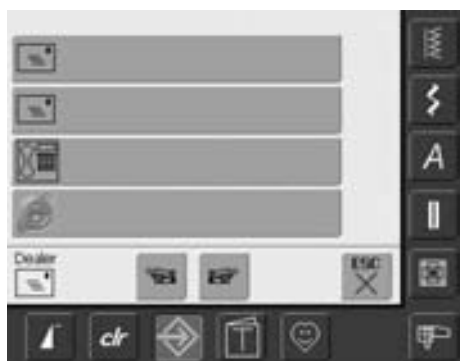

- the screen «Dealer Details» opens
- by touching the designated gray bar, the following personal information of your BERNINA dealer can be entered:
 - Store name
 - Last name, First name
 - Phone number
 - Website or email address
- touch «To Next Page»

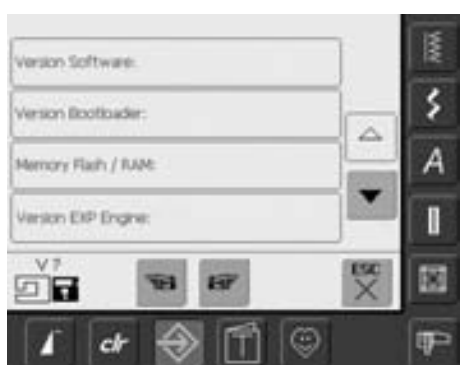

- the screen «Version» opens
- the current version of the sewing computer and the embroidery module (must be attached) are visible
- by touching the arrows the version details can be scrolled



Closing Screen

- touch «ESC»
- the screen closes and the selection menu appears

Updating the Sewing and Embroidery Computer

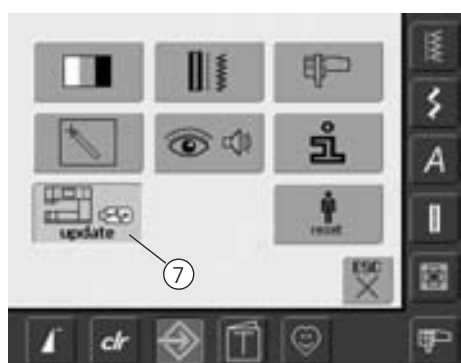

Opening Setup Program

- press the Setup button
- selection menu appears
- insert the USB stick with the new software version into the right side of the sewing computer
- touch «7»



There are two possible ways to receive new data:

1. as download from the Internet
2. from all authorized BERNINA dealers

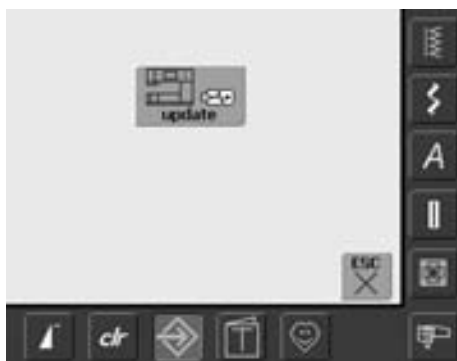

- the «update» screen appears
- touch «update»
- the updating process is started
- checks are made whether:
 - a BERNINA USB stick is inserted
 - there is enough free memory available
 - the correct software version is on the stick
- customer specific data and settings will be saved and memorized once again during the process
- if the update was successfully carried out it will be displayed by a message, and the sewing and embroidery computer is ready again for normal use with the new version

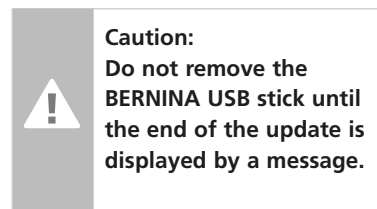

Reset to Factory

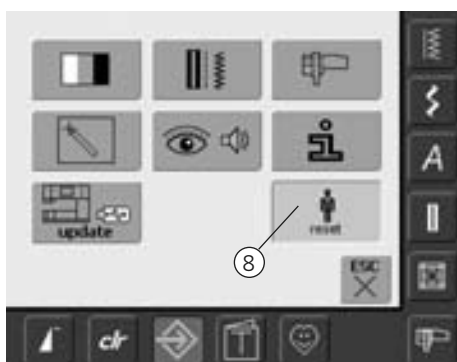

Opening Setup Program

- press the Setup button
- selection menu appears
- touch «8»
- a summary of the screen appears



- two choices are possible:
 - Reset to Factory settings
 - Deleting Personal Data
- touch «Reset Settings»



Reset to Factory

- three choices are possible:
 - Sewing
 - Embroidery
 - All
- touch the on-screen button which you want to «Reset to Factory»
- confirm the appearing Display Message with «OK»
- in the selected area the settings are the default settings and the previous screen appears
- touch «ESC» until the selection menu appears

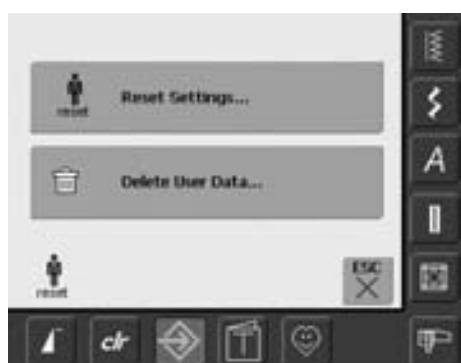

- touch «Delete User Data»

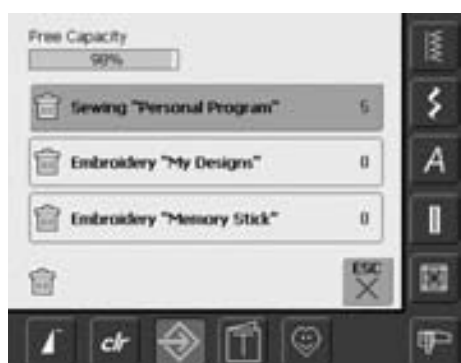

Deleting Personal Data

- three choices are possible:
 - Sewing «Personal Program»
 - Embroidery «My Designs»
 - Embroidery «Memory Stick» (the Memory Stick must be plugged into the sewing computer)
- touch the button of which the data should be deleted
- confirm the appearing display message with «OK»
- the data is deleted and the screen reverts to the previous screen
- touch «ESC» until the selection menu appears

Balance

All stitches are checked and fully adjusted before the sewing computer leaves the factory.

Different fabrics, threads, stabilizers and interfacings can affect programmed stitches so that they are not sewn out properly.

These effects can be corrected with the electronic Balance so that the stitch formation can be adjusted where necessary to suit the fabric.

Balance for Practical and Decorative Stitches

When sewing soft fabrics such as jersey or tricot, the fabric tends to stretch under the presser foot which also stretches the stitch being sewn. For example, the Honeycomb stitch opens up and is too long. Thicker fabrics might cause the stitch to overlap, making it too short. Correcting with the Balance is very easy.



Opening Balance

- touch the function «Balance»

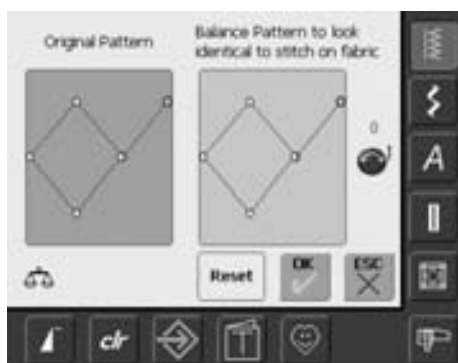

Balance Screen

- the special Balance screen opens
- in the left portion of the screen the stitch is displayed in its original form
- in the right portion of the screen the alterations made are directly visible
- the corrections can be made while sewing (with opened screen)



Saving and Closing Screen

- touch «OK»
- the corrections will be saved and the Balance screen will close



Closing Screen

- touch «ESC»
- the Balance screen closes; returns to previous screen

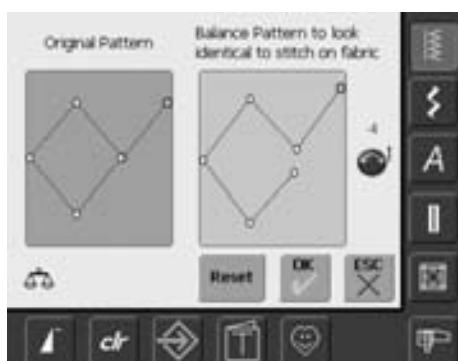

Corrections

- the stitch sewn on the fabric (e.g. the Honeycomb stitch) opens up and it does not look correct:
- turn the stitch length knob (displayed by a blue symbol on the screen) until the stitch in the right portion of the screen is identical with the stitch on the fabric



Deleting Corrections

- touch «Reset»
- the corrections of the selected stitches will be deleted

Cleaning

If the sewing computer is stored in a cold room, it should be brought to a warm room about one hour before use.



Cleaning the Stitch Plate

Periodically remove thread lint and remnants which collect under the stitch plate and the hook.

- turn power switch to «0» (off) and pull out plug from electrical outlet
- remove presser foot and needle
- open the free arm cover
- press the stitch plate down at the back right corner, lift and remove
- clean the area with the lint brush
- replace the stitch plate

Cleaning the Screen and the Sewing Computer

- wipe with a damp cloth



Cleaning the Hook

- turn power switch to «0» (off) and pull out plug from electric outlet
- remove the bobbin case
- push the release lever to the left
- let down the locking lever and the black hook race cover
- remove the hook
- clean the hook race, never use a sharp instrument
- replace the hook, turning the handwheel if necessary so that the hook driver is on the left
- close the hook race cover and secure with the locking lever, the locking pin must engage
- check by turning the handwheel
- insert the bobbin case



Lubricating

- turn power switch to «0» (off) and pull out plug from electric outlet
- squeeze one drop of oil into the hook race
- run the sewing computer for a short time without thread to prevent oil soiling your work



Caution:
Disconnect plug from the socket before cleaning or lubricating!



Never use alcohol, petrol, white spirit or any type of solvent to clean the sewing computer!

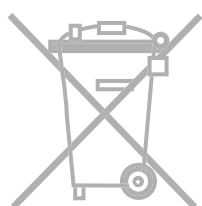

BERNINA is committed to the protection of the environment. We strive to minimize the environmental impact of our products by continuously improving product design and our technology of manufacturing.

At end of life please dispose of this product in an environmentally responsible way according to the national directives. Do not throw away this product with your household waste. In case of doubt, please contact your dealer.

Trouble Shooting

In most cases you will be able to identify and remedy faults by checking the following.

Check whether:

- the upper and lower threads are threaded correctly
- the needle is inserted correctly with the flat side to the back
- the needle size is correct – check the needle/thread table page 17
- the sewing computer is clean – brush out any thread lint
- the hook race is clean
- any threads are trapped between the tension discs or under the bobbin case spring

Upper Thread Breaks

Possible Faults:

- The upper thread tension is too tight.
- The needles are of a poor quality. Ideally needles should be purchased from your BERNINA dealer.
- The needle has been inserted incorrectly. The flat side of the shank must be to the back.
- The needle is bent or blunt.
- Poor quality, knotted or dried out thread has been used.

Possible Solutions:

- Use the correct spool disc.
- Stitch plate or hook tip damaged. Take your sewing computer to your BERNINA dealer.

Removing Trapped Thread

If the lower thread breaks and the thread is trapped in the area of the take-up lever, proceed as follows:

- power switch to «0» (off)
- remove the screw on the head frame with the angular Torx key
- pull head frame to the left
- remove remnants of thread
- attach head frame and tighten screw

Lower Thread Breaks

- The lower thread tension is too tight.
- The bobbin is jamming in the bobbin case:
- Remove and replace the bobbin.
- The hole in the stitch plate has been damaged by the needle:
- This must be repolished by an authorized BERNINA technician.
- The needle is blunt or bent.

Calibration of the Display

To open the calibration screen directly, proceed as follows:

- press both needle position buttons on the body simultaneously and keep them pressed
- turn on the sewing and embroidery computer

- as soon as the calibration screen is opened, release the two buttons
- Calibration of the Display see page 96

Skipped Stitches

- Wrong needles used:
- Use only 130/705H system.
- The needle is blunt, bent or incorrectly inserted:
- Push right to the top when inserting.
- Needle is of inferior quality or badly polished.
- The needle point does not suit the fabric being sewn. If necessary use a ball point for knitted fabrics and cutting point for hard leather.

Needle Breaks

- Needle clamp screw loose.
- Fabric taken out in front of instead of behind the presser foot.
- When sewing over a thick area, the fabric was pushed with the needle still in the fabric; use Jeans foot No. 8 (optional accessory).
- Poor quality thread, unevenly wound or knotted.
- Information on needles see page 18

Faulty Stitching

- Remnants of thread between the tension discs:
 - pull folded, thin fabric (do not use fabric edge) between the tension discs and clean them by moving the fabric forwards and backwards on the left and right side of the thread tension
- Remnants of thread under the bobbin case spring.
- Lower thread still threaded in the bobbin case finger.
- Incorrect threading. Check upper and lower threads.
- Use the correct spool disc.

Cannot Sew Thick Fabric

- Needle/thread combination is not correct (the thread is too thick for the inserted needle).
- Use hight compensating tool, when sewing over a thick seam.

Sewing Computer Fails to Run or Runs Slowly

- Plug not properly inserted.
- Power switch in off position («0»).
- Sewing computer has been standing in a cold room.
- restart sewing computer

Defective Sewing Light

- Please note that the CFL-sewing light must be replaced by an authorized BERNINA technician.

Upper Thread Indicator Sensor

- not activated in the Setup Program

Service Data

Service data of the actual condition of your sewing and embroidery computer can be saved on a USB stick and sent to your authorized BERNINA dealer:

- insert the USB stick into your sewing and embroidery computer
- press the «Setup» button and select the symbol «i» (information)
- use the «To Next Page» symbol to change to the previous screen
- touch «LOG»
- data is saved on the USB stick
- remove the USB stick











Update error

If the update process is at a still stand (hour glass remains) proceed as follows:

1. Remove the USB stick and turn off the Sewing/Embroidery computer
2. Turn on the Sewing/Embroidery computer and proceed with the update as indicated by a message on the display

Messages on the Screen

In special cases messages may appear on the screen. They serve as a reminder, warning, or confirmation of selected applications and functions.

| | Message | Notes |
|---|--|---|
|  | Warning | The user must do something, before the function can be carried out, or the user's attention will be drawn to a specific fact. |
|  | Query | Does the user really want to carry out the function? For example delete data, etc. |
|  | Security Program active | Deactivate if required |
|  | This stitch number is not available in the sewing computer. | Put in another stitch number. |
|  | Combi Mode does not support this pattern. | Stitch No. 5 cannot be selected in Combi Mode. The sewing computer does not react when selecting such a stitch. |
|  | Switch feed dog to sewing position. | Press the button «Drop feed dog». The message disappears automatically if the feed dog position was changed. |
|  | Thread breakage or empty spool. | Check upper thread and perhaps lower thread. |
|  | The winder is on. | The winder speed can be changed with the stitch width knob or the «+» and «-» on-screen buttons. If the winder is turned off or «ESC» is pressed, the message disappears automatically. |
|  | Lower presser foot | The message disappears automatically if the presser foot was lowered. |
|  | Raise presser foot | The message disappears automatically if the presser foot was raised. |



Needle will penetrate presser foot or stitch plate.

Check the settings in the Security screen.

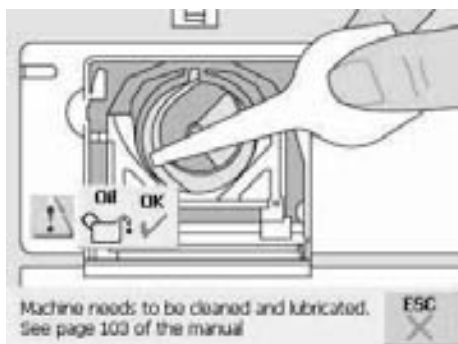

The sewing computer must be cleaned / lubricated.

Corresponding instructions are on page 103 of the manual.

This notification will appear after approx. 180,000 stitches. After cleaning/oiling clear the display by touching «OK». The display can be cleared temporarily by touching «ESC», but will appear again when restarting the sewing computer. After clearing with «ESC» for the third time, the cleaning notification will only appear again after a further approx. 180,000 stitches.



Service Notification

The sewing computer must be taken for a service to a BERNINA dealer.

The notification will appear after approx. 2,000,000 stitches. If the service was done by the BERNINA dealer, the stitch counter will be on «0» again and the display does not appear anymore. The display can be cleared temporarily by touching «ESC», but will appear again when restarting the sewing computer. After clearing with «ESC» for the third time, the notification will appear again at approx. 4,000,000 stitches.



Deleting or overwriting data , e.g. Drawers.

Confirm with «OK» or cancel with «ESC».

Main motor failed. Check hook system.

Remove any thread lint from the hook area / bobbin case.

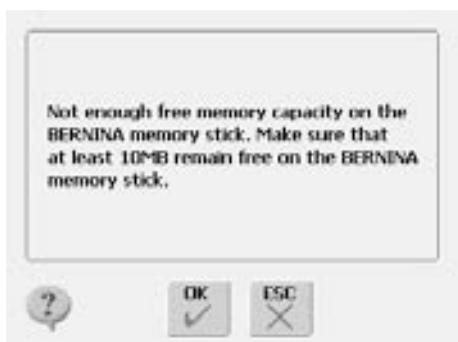

Not enough memory on the USB stick.

Delete data on the USB stick



Update files not complete.

There is no Personal Data for restoring on the BERNINA Memory Stick. Please check whether you have inserted the correct BERNINA Memory Stick and restart the sewing computer.

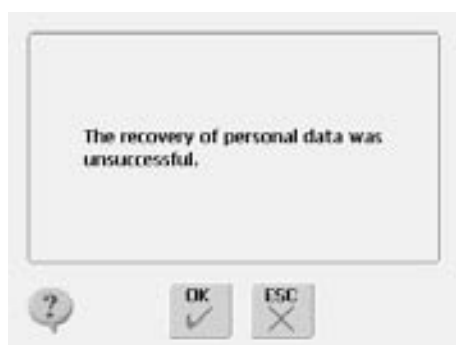

Stored settings/personal data missing.

Repeatedly (3 times) no Personal Data for restoring was found on the BERNINA Memory Stick. The automatic update was cancelled. The software was updated correctly, but your personal data could not be restored.

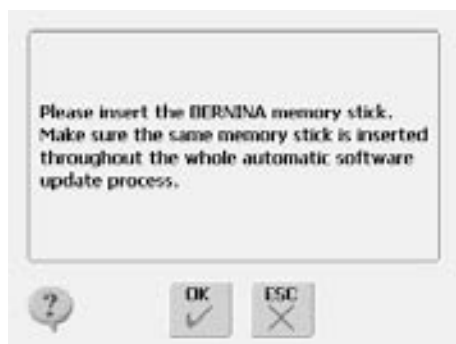

BERNINA Memory Stick not inserted.

Insert the BERNINA Memory Stick with the update data into the sewing computer, and only remove it when the automatic update is completed.

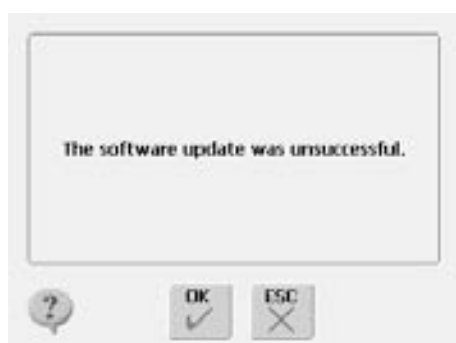

The update was not carried out.

The original software version is still on the sewing computer. Insert the BERNINA Memory Stick with the update data into the sewing computer and restart the update. Check the update data on the BERNINA Memory Stick. Your sewing computer might already be provided with the latest software version.



The update was successful.

The sewing computer is provided with the latest software version and ready for further use.

Setting up the Embroidery Computer

Details

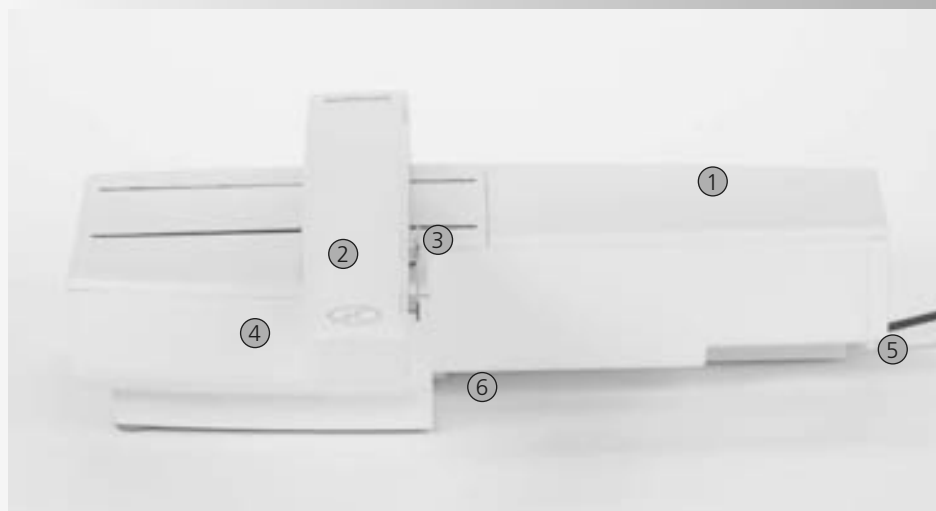

Front view

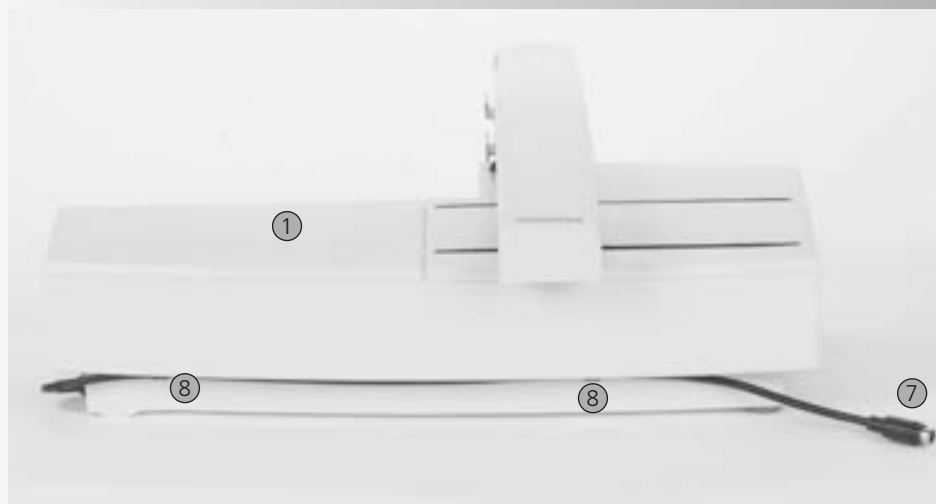

Back view

- 1 Embroidery surface
- 2 Embroidery arm
- 3 Embroidery hoop connection
- 4 Accessory box
- 5 Connecting lug right
- 6 Connecting lug center
- 7 Sewing computer connecting cable
- 8 Cable holder



The side view (handwheel) of the sewing and embroidery computer with the cable connections are shown on page 7 of the sewing computer instruction manual.

Standard Accessories*



Large oval embroidery hoop
(145x255mm)
Template for large oval embroidery hoop
VAR. 01 for a630



Embroidery presser foot No. 26
Net for upper thread spools – pull over
upper thread spool for even spooling

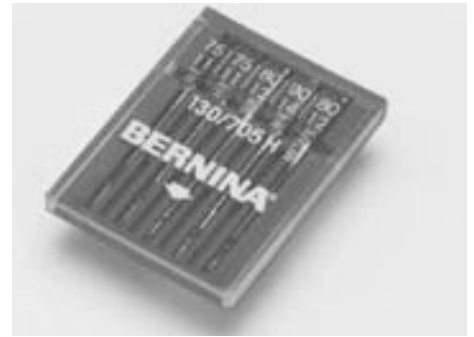

Embroidery needle range



Embroidery module bag



USB connecting cable for PC embroidery
software



Embroidery software Editor Lite

* can vary from market to market

Optional Accessories*

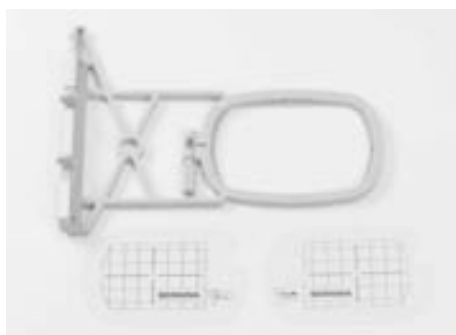

Small embroidery hoop (72x50mm)
(for normal use and free arm embroidery)
Blue template for normal use
Red template for free arm embroidery



Medium embroidery hoop (100x130mm)
Template for medium embroidery hoop



Embroidery Mega-Hoop (150x400mm)
Template for Mega-Hoop,
VAR. 01 for a630



Adapter for free arm embroidery

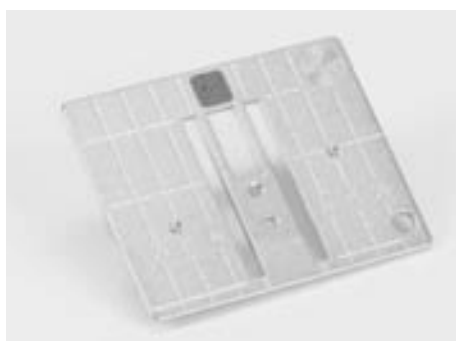

Straight stitch plate 5.5mm



BERNINA USB Stick



BERNINA artista software



BERNINA Multiple spool holder



Suitcase system for sewing computer and embroidery module



BERNINA embroidery cards/Magic Box

* can vary from market to market

Attaching the Module to the Sewing Computer

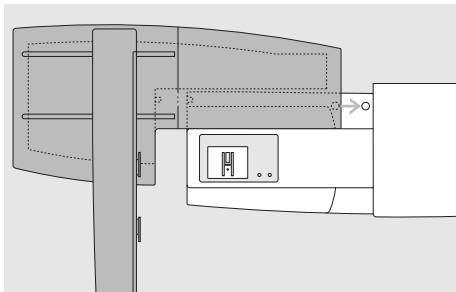

Attaching the Module to the Sewing Computer

- place the module on the sewing computer behind the free arm
- push the module from the left towards the sewing computer so that the connecting lugs engage in the base plate

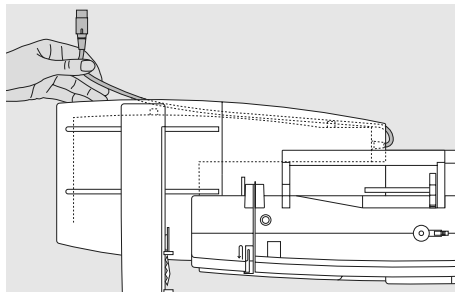

Releasing the Cable

- the cable connects the module to the sewing computer
- pull the cable out of the holder on the back of the module

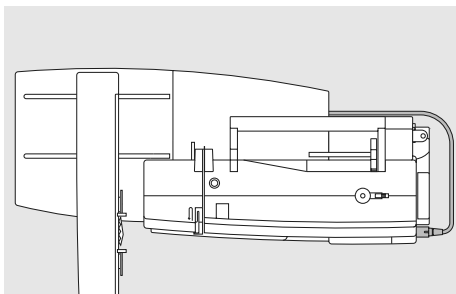

Connecting the Cable

- plug with flat side to the front
- insert the plug into the socket on the right hand side of the sewing computer

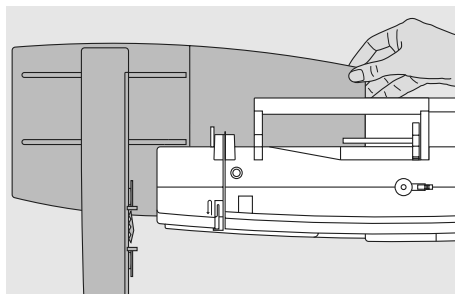

Removing the Module

- grip the back right corner to lift the module and remove to the left

Releasing the Cable

- pull out the plug

Storing the Cable on the Module

- insert the cable into both cable holders
- press cable gently to secure



Caution!
When connecting the embroidery module, attention must be paid that all items are on a flat and even surface!

Caution!
Always separate the module and sewing computer for transportation. Never transport them attached.

Connecting the Adapter for Free Arm Embroidery (Optional Accessory)

The adapter is used for embroidering tubular items (sleeves, trousers, infant items, socks, etc.) on the free arm of the sewing computer.

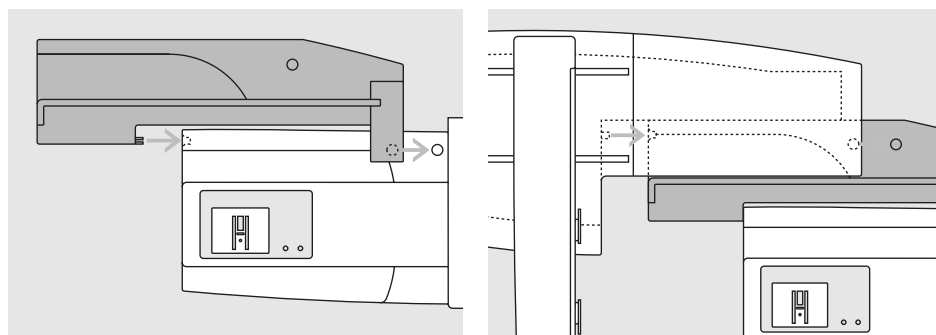

Attaching the Adapter to the Sewing Computer

- push the adapter behind the free arm towards the sewing computer so that the connecting lugs engage in the base plate of the sewing computer

Attaching the Module to the Adapter

- place the module on the adapter with the front edge of the module as close as possible to the L-shaped guide on the adapter
- push the module towards the guide from the left until the connecting lugs engage in the base plate of the adapter

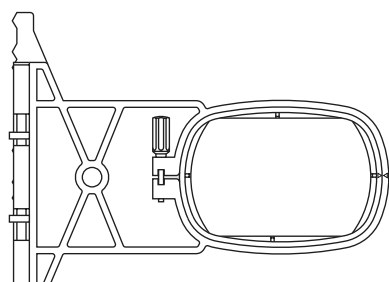

Free Arm Embroidery Hoop

- the small, oval embroidery hoop is specially designed for free arm embroidery



Caution!
Only the small hoop can be used for free arm embroidery.

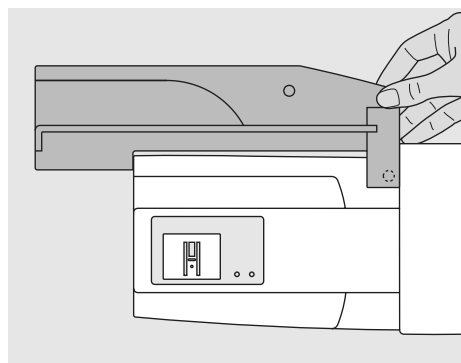

Removing the Adapter

- remove the module from the adapter
- the rear right corner of the adapter is designed to be used as a grip
- hold the adapter with this grip and remove from the base plate of the sewing computer

Preparing the Embroidery Computer for Embroidery



Embroidery Presser Foot No. 26

- attach the Embroidery presser foot No. 26
- raise the presser foot so that the embroidery hoop can be attached



Needles for Embroidery

- depending on the embroidery thread use needle size 75 to 90
- use special embroidery or Metafil needle for embroidery or metallic thread
- use an undamaged needle
- raise the needle so that the embroidery hoop can be attached

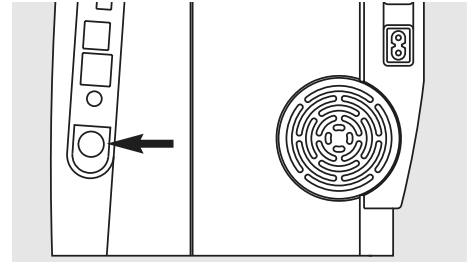

Lower the Feed Dog

- press the button on the right side of the sewing computer to lower the feed dog

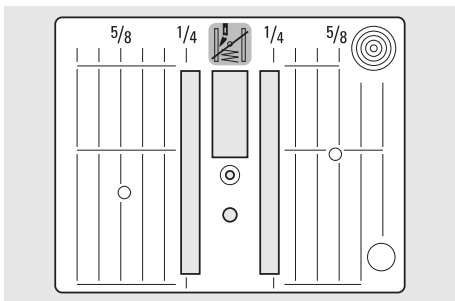

Straight Stitch Plate (optional accessory)

- the straight stitch plate has a small needle hole. The needle insertion points (upper and lower thread stitching) are limited, which produces a better embroidery result
- remove the standard stitch plate and replace it with the straight stitch plate



Threading Upper and Bobbin Thread

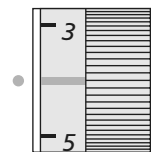
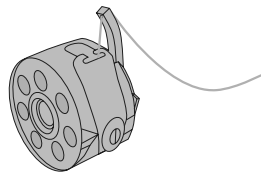
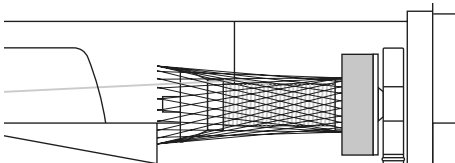

Threading the Upper Thread

- attach foam pad and place the upper thread spool
- when using Rayon or slippery embroidery threads, slip the net over the upper thread spool
- this prevents the upper thread from slipping and gives an even thread feed

Threading the Bobbin Thread

- for embroidery, insert the thread into the finger of the bobbin

Adjusting the Thread Tension

The artista 630 has manually adjusted thread tension.

- the tension should be set to between 2.5 - 4.5 for all embroidery
- adjustments for difficult or unusual fabrics can be made if necessary



While embroidering the bobbin can also be wound, just like in sewing.



Spool pin

When using metallic or specialty threads, using the vertical spool pin and the supplementary thread guide (optional accessory) may also help avoid problems.



Hooping the Fabric

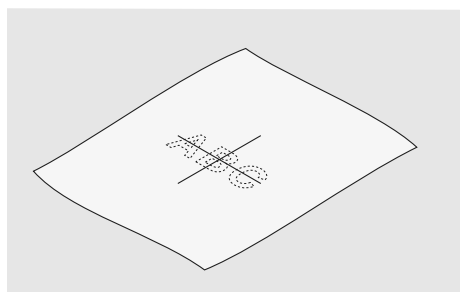

Centering

- determine the center of the fabric to be embroidered
- mark with a fabric marker or chalk

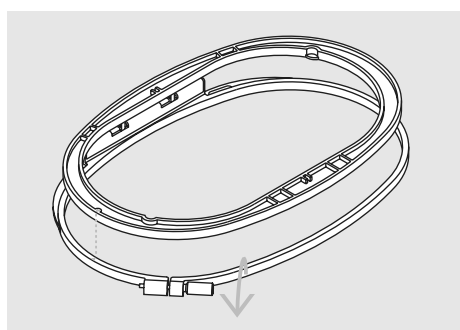

Using the Embroidery Hoop

- loosen the screw(s)
- remove the inner hoop
- the arrows on both hoops should match
- the arrows on the medium and large hoops are at the center front and on the right hand side of the small hoop

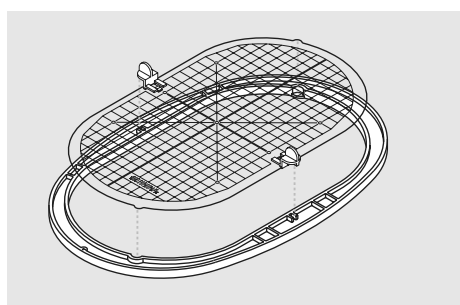

Embroidery Template

- there is a template for each embroidery hoop
- the embroidery surface is marked in 3/8" (1 cm) squares
- the center and corners are marked with holes for transferring marks to fabric
- place the template in the inner hoop so that the word BERNINA is at the front (by the arrows) and can be read
- the template will engage automatically in the inner hoop
- there are finger holes for removing the template from the small and medium hoops, and special attachment clips for the large hoop template

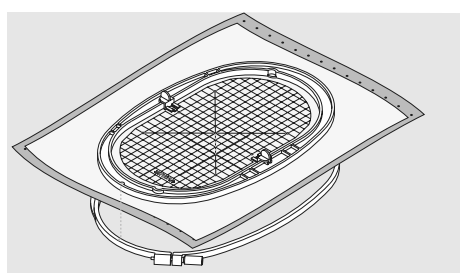

Hooping the Fabric

- place fabric on top of the outer hoop
- place the marked center point in the center of the template on inner hoop
- match the arrows of inner and outer hoops
- place inner hoop on top of fabric and outer hoop and press into place, loosening screws to accommodate fabric. Tighten screws
- remove template

Embroidery Stabilizers

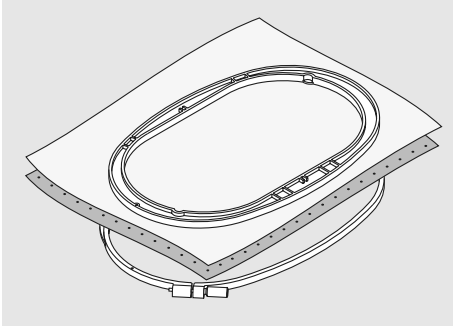

Tear-away Stabilizers

- similar to interfacing; tears like paper
- one or more layers can be used
- available in different weights
- for more stability, apply to the wrong side of the fabric with temporary spray adhesive before hooping
- carefully tear away excess stabilizer from the back of the embroidery after stitching
- stabilizer will remain under larger embroidered areas

Application:

- for all woven fabrics and fabrics which are not elastic

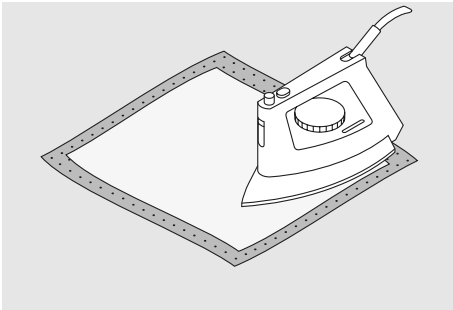

Iron-on Interfacing

- must be preshrunk by soaking in warm water
- this is pressed (fused) to the wrong side of the fabric
- iron-on interfacings are available in a variety of weights and should be selected to suit the fabric being used
- removable iron-on interfacing is also available

Application:

- to provide body and shape for fabrics onto which motifs will be placed
- use in conjunction with appropriate stabilizer

Cut-away Stabilizers

- one or more layers can be used
- available in light- and heavyweight
- for more stability, apply to the wrong side of the fabric with temporary spray adhesive before hooping
- carefully cut away from the back of the embroidery after stitching
- stabilizer will remain under larger embroidered areas

Application:

- for all elastic fabrics, especially suited for knits

Paper Backed Adhesive Stabilizer

- place stabilizer in hoop, paper side up
- use a pointed object (e.g. scissors) to score the paper and remove it to reveal the self-adhesive surface
- position the piece of fabric to be embroidered on the stabilizer

Application:

- intended for delicate fabrics such as jersey or silk
- for hard to hoop sections and fabrics such as velvets



When using paper backed adhesive stabilizer make sure that the adhesive residue on needle, stitch plate and hook area is removed.

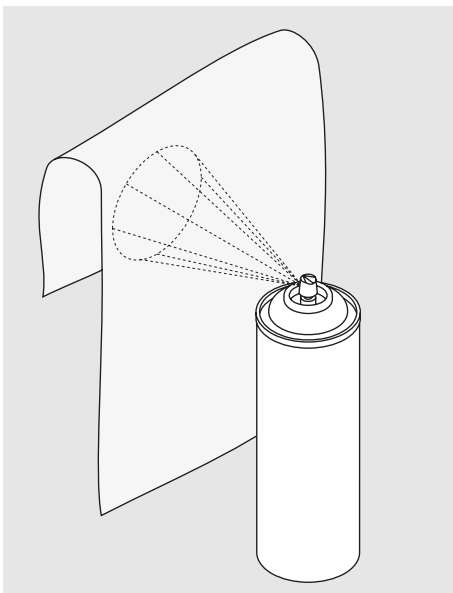

Adhesive Spray

- Please avoid using adhesive spray next to your embroidery system
- for more stability, spray the stabilizer and adhere to the wrong side of the fabric carefully smoothing fabric so there are no puckers
- Use adhesive carefully and spray from a distance of 25cm - 30cm (9.8 inches to 11.8 inches)

Usage:

- Stretch and knitted material: to retain shape
- Appliqué: position appliqués perfectly
- Two or more pieces of fabric: avoid slipping of fabric layers
- Fabric pieces: position fabric pieces on stabilizer, i.e. pocket flaps
- Napped fabrics (i.e. velvet) that should not be clamped in the hoop because of the possibility of getting hoop marks

Spray Starch for Additional Stiffening

- spray starch is ideal for stiffening fine, soft or loosely woven fabrics
- spray the area to be embroidered, let dry or press gently with a warm iron
- always use an additional stabilizer such as water soluble stabilizer on the wrong side of the fabric

Application:

- ideal for fine, loosely woven fabrics, e.g. batiste, fine linen, etc.

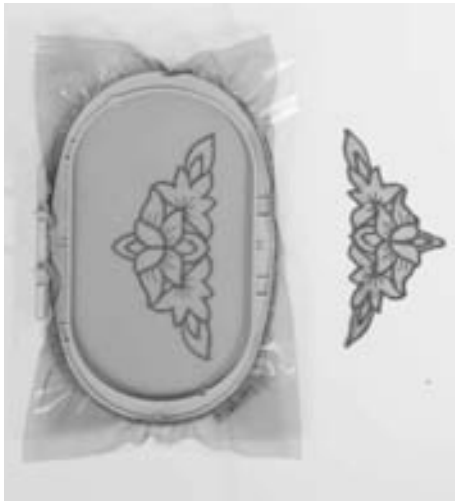

Water Soluble Stabilizer for Fabric With a Pile and Lace Embroidery

- water soluble stabilizer looks like plastic wrap
- dissolve stabilizer in warm water when embroidery is complete
- water soluble stabilizers are ideal protection for fabrics with a thick or looped pile such as toweling
- place on top of toweling and high nap fabrics backed by appropriate stabilizer for fabric and motif. This also prevents the threads from sinking into the fabric and prevents fabric from showing between embroidery stitches
- use spray adhesive to fix stabilizer if necessary
- for fabric with a pile, reinforce with additional, suitable stabilizer on the wrong side if necessary
- for lace embroidery place one or two layers of water soluble stabilizer in hoop (as the motif is not embroidered on any fabric, only the thread embroidered motif is left)
- after dissolving lay the motif down flat and let dry

- water soluble stabilizer can also be removed by gently tearing it away when used as a topping on non-washable fabrics like velvet

Application:

- ideal for toweling, velvet, bouclé knits, etc.
- ideal for fine, sheer fabrics such as organdy, batiste, etc.
- recommended for use as a stabilizer with low stitch count motifs
- use heavier water soluble stabilizer to stitch lace motifs

Important Embroidery Information



Choosing an Embroidery Motif

- simple motifs with a low stitch count are suitable for embroidery on fine fabric
- large-scale, densely embroidered motifs (e.g. with multiple color and embroidery direction changes) are suitable for medium- and heavyweight fabrics



Embroidery Test

- always stitch an embroidery test on a sample fabric. Adjust color, thread quality, needle, stitch density, tension, etc. to suit the motif if necessary
- for the test use the same fabric and stabilizer that you will use on the project

Scaling/Sizing Motifs

- motifs can be scaled/sized on the embroidery computer or with the artista software on the PC
- to get good results, the motifs should be scaled within the limits of 75% to 150%

Different Stitch Types

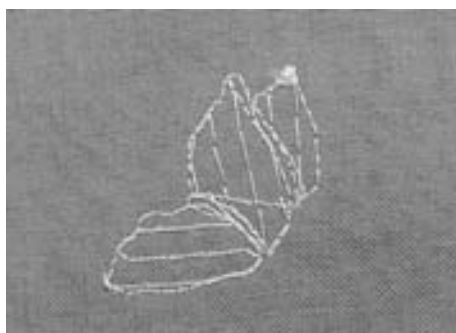

Underlay Stitches

- underlay stitches are the foundation of a motif and are used to stabilize the base fabric and hold it in shape. They also prevent the covering stitches of the motif from sinking into the knit or the nap of the fabric

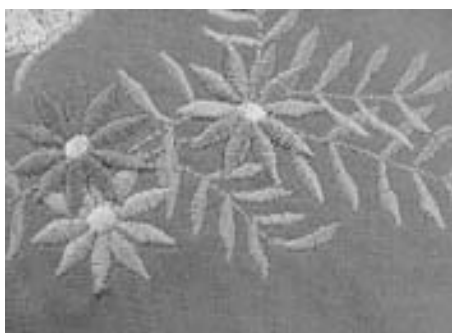

Satin Stitch

- a satin stitch is a dense zig-zag
- satin stitches are suitable for filling small and narrow areas. They are not suitable for filling large areas, as long stitches are too loose and do not cover the fabric properly. In addition there is the danger that with too long stitches the threads could catch on something which would damage the embroidery



Step Stitch

- a fill stitch with stitches of specified length sewn in rows used primarily to fill large areas quickly



Fancy-Fill Stitches

- to give areas a special effect
- stitches that create a motif with an area to be filled



Outline Stitches

- usually straight or satin stitches
- used to define a specific area or areas
- examples are: straight stitch, double run, triple run, satin

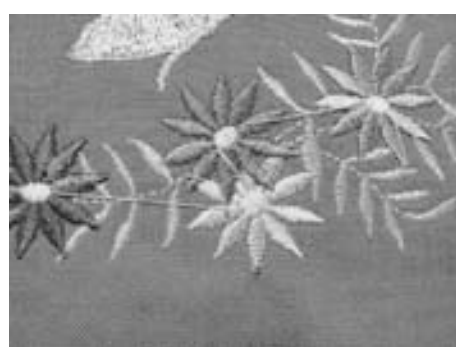

Jump Stitches

- long stitches that skip over fabric after one part of the motif finishes and the next begins
- before and after the jump stitch securing stitches are sewn
- jump stitches are trimmed before the next color starts to embroider

Embroidery Threads



 When sewing with metallic threads, we recommend the use of the vertical spool pin and the supplementary thread guide (optional accessory).

One of the most important elements in successful embroidery is the quality of the thread. We strongly recommend that you purchase thread from a reputable BERNINA dealer in order to avoid irregularities, thread breakage, etc. which so often occur with poor quality threads.

Embroidery is particularly effective if you use glossy rayon or polyester embroidery threads as upper threads. They are available in a wide range of colors for beautiful embroidery.

Polyester Threads

Polyester with a brilliant sheen is a hard wearing colorfast thread and has a high tensile strength. It is suitable for all types of embroidery, especially children's clothing and items which will be washed often or subject to much wear and tear.

Rayon Threads

Rayon is a soft viscose fiber with a brilliant sheen and suitable for fine, delicate embroidery, or items that will not receive excessive wear and tear.

Metallic Wrapped Polyester Thread

Metallic thread is a light- to mediumweight thread suitable for special effects in embroidery.

Preferably use with a Metafil 130/705 H-MET needle or Organ needle of varying sizes.



Embroidery Needle

- correct size thread must correspond with correct size needle
- replace needle regularly

Bobbin Threads



 Use white bobbin thread or match color with fabric.

Bobbin-Fil (special bobbin thread)

Bobbin-Fil is an especially soft and light polyester thread suitable for bobbin thread. This special bobbin thread ensures a steady thread tension and an optimal intertwining of the upper and bobbin thread.

Darning and Embroidery Thread

Fine mercerized cotton thread suitable for embroidery (Mettler 60 weight suggested), which is embroidered on cotton fabric.

Selecting Embroidery Motifs



Welcome Screen

- after turning the embroidery computer on, the Welcome screen appears for a few seconds, provided that a text was entered in the Setup Program

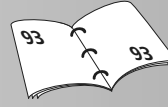

Embroidery Requirements

- a special screen with reference to the embroidery requirements appears:
 - remove embroidery hoop
 - attach Embroidery presser foot No. 26
 - raise presser foot
 - thread the bobbin thread into the finger of the bobbin case
 - lower feed dog
- if all embroidery requirements are fulfilled, close the screen with «OK»
- the embroidery hoop will MOVE



«Embroidery Computer» On-screen Button

- touch «Embroidery Computer» in the Selection menu



«USB Stick» Button

- touch «USB Stick»
- the motifs of the stick (optional accessory) appear in color on the display (provided that a stick is inserted)
- select a motif by touching the appropriate on-screen button



- built-in embroidery motifs can be selected with the on-screen buttons «Alphabets», «Motifs» and «My Designs»



Selecting Alphabets

- touch «Alphabets» in the Selection menu
- the different alphabets are visible on the display
- select one of the alphabets
- a screen with a keyboard appears

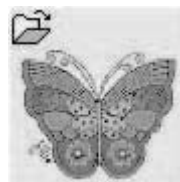

Selecting Motifs

- touch «Motifs» in the Selection menu
- the motifs appear in color on the display
- select a motif by touching the appropriate on-screen button

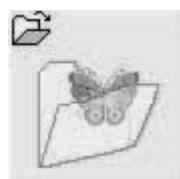

Selecting My Designs

- touch «My Designs» in the Selection menu
- the saved personal motifs appear in color on the display
- select a motif by touching the appropriate on-screen button

Starting to Embroider

Selecting the Embroidery Hoop



Edit 1 Screen

- select an embroidery motif from the various choices of motifs
- the screen «Edit 1» appears



- the selected embroidery motif is shown in the most appropriate (smallest possible) hoop
- the «Hoop» on-screen button shows which hoop should be attached
- attach the recommended hoop

Attaching the Embroidery Hoop

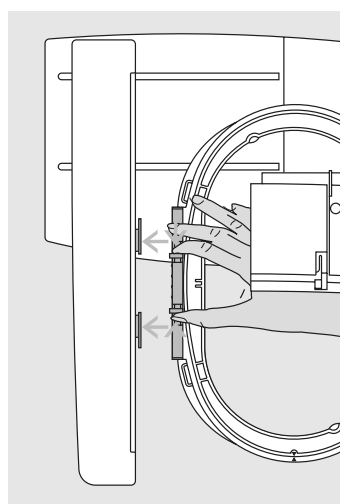

Raising Needle and Embroidery Presser Foot

- raise needle and embroidery presser foot
- hold the hoop with the right side of the fabric up and the attaching mechanism to the left

Attaching the Hoop

- pass the hoop under the embroidery presser foot
- squeeze the ends of the attaching mechanism on the side of the hoop
- position the center points of the hoop (small attachment clamps) over the bracket of the embroidery arm

- push the hoop down until it engages
- release the attaching mechanism of the hoop

Removing the Hoop

- press both ends on the hoop attaching mechanism towards each other
- pull up to remove the hoop

Embroidering Motifs

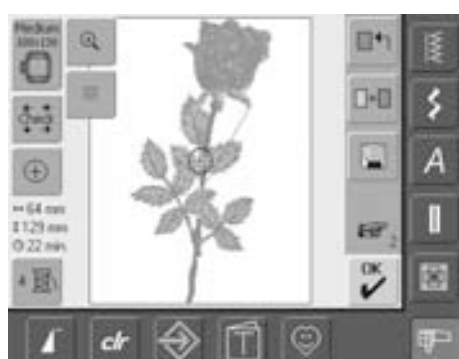

- touch «OK» or press the Start-Stop-button on head frame
- embroidery computer moves to check if hoop is attached



Embroidery Menu

- the Embroidery menu opens with the embroidery motif
- the embroidery motif is ready to be embroidered

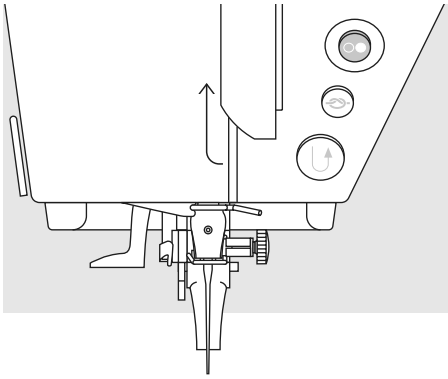

Starting to Embroider With the Start-Stop-Button on Head Frame

- lower the presser foot
- keep the Start-Stop-button on the head frame depressed until the embroidery computer starts
- the embroidery computer will sew approximately 7 stitches and stop automatically
- a screen indicates that the thread tail has to be cut at the beginning of the motif
- raise the presser foot
- cut the thread tail at the beginning of the motif
- lower the presser foot
- press the Start-Stop-button on head frame to resume embroidering

Interrupting With the Foot Control

- when the embroidery computer is embroidering, press the Start-Stop-button on head frame or tap the foot control lightly
- the embroidery computer will stop immediately

Completing the Color

- lower the presser foot again
- press the Start-Stop-button on head frame or the foot control again
- the embroidery computer embroiders all the sections in the color activated
- the embroidery computer stops automatically when complete

Changing Color

- the embroidery computer is automatically ready to embroider the next color
- change color of the upper thread accordingly
- embroider with the new color

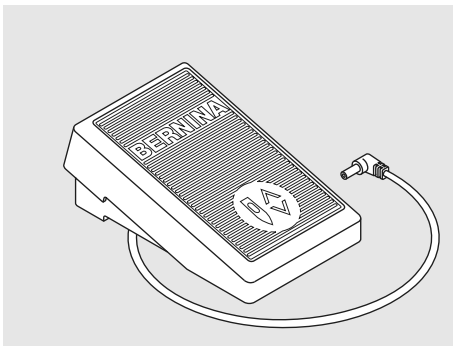

Starting to Embroider With Foot Control

- lower the presser foot
- press the foot control
- the embroidery computer will stop automatically after approx. 7 stitches
- a screen indicates that the thread tail has to be cut at the beginning of the motif
- release the foot control
- raise the presser foot
- cut the thread tail at the beginning of motif
- lower the presser foot
- when embroidering with the foot control always keep it depressed

Cutting Thread Ends After Embroidery

- raise the presser foot
- remove the embroidery hoop from the embroidery arm
- cut threads close to the motif
- carefully remove any connecting threads from the embroidered area
- take care that the bobbin thread is not cut too closely to the stitch plate when removing the embroidery hoop

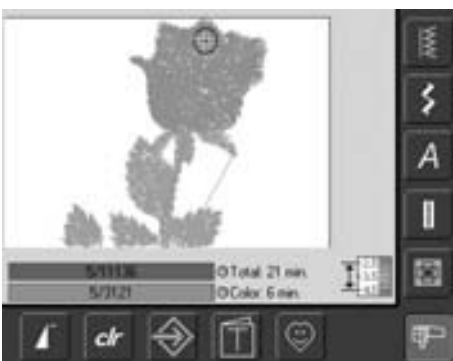

Embroidery Screen

- after starting to embroider the Embroidery screen appears

On-screen Functions and Displays



After turning on the embroidery computer or changing from Sewing to Embroidery Mode, the Selection menu appears. This happens when a motif is selected or combined with an existing motif.



Return to Selection Menu

- this function appears after selecting one of the following functions: «Alphabets», «Motifs» or «My Design»
- touch symbol
- Selection menu appears



Closing Special Applications

- this function appears if changing from the Edit 1 screen back to the Selection menu
- touch symbol
- the special application closes
- returns to previous screen



Scroll Up

- touch symbol one or more times
- the screen content scrolls up to show more options
- touch the symbol continuously to scroll quickly



Scroll Down

- touch symbol one or more times
- the screen content scrolls down to show more options
- touch the symbol continuously to scroll quickly

Common Functions and Displays of Screens Edit 1 and Edit 2



Edit 1 Screen

After selecting a motif the Edit 1 screen appears. In this menu for example new motifs can be selected or combinations made by combining designs.

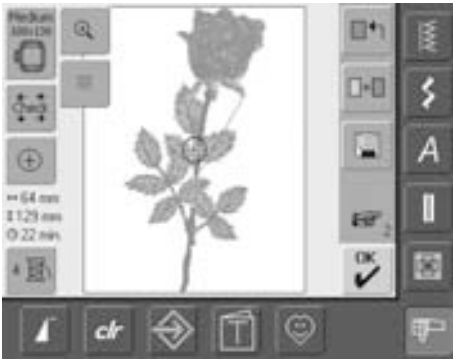

Edit 2 Screen

The Edit 2 screen is used to alter motifs (e.g. Rescale Motif Proportionally, Mirror Image, Rotate Motif, etc.).

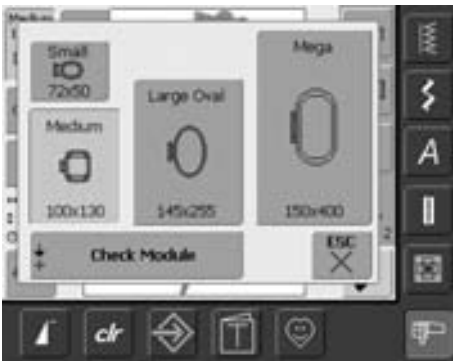

Select Hoop

- display of the most appropriate hoop for the selected motif
- touch on-screen button
- the display «Select Hoop» appears
- each hoop size is displayed with maximum stitch field in mm

Possible Hoop Selections (display «Select Hoop»)

- select hoop (Small, Medium, Large Oval or Mega)
- the display closes and the selected hoop is visible on the «Hoop» on-screen button
- by touching «Check Module» the embroidery module is calibrated (reads the reference points). **No embroidery hoop must be attached!**
- the display can be closed by touching the «ESC» on-screen button, without selecting a hoop



Check

- touch symbol
- the hoop moves vertically so that the size of the attached hoop may be read in the embroidery computer
- if only the hoop should be read, touch «ESC»
- motif stitching area is read with the 4 arrows
 - lower left
 - upper right
 - lower right
 - upper left
- in a stitch combination the stitching area of the complete motif but also the stitching area of the individual motif can be read
- select the desired motif within the combination with the symbol «Retrieve»
- return to the Edit menu with «ESC»
- attached hoop is displayed
- if no hoop or a too small hoop is attached, an error message will appear



Motif Center

- touch symbol
- the center of the motif is indicated by the cursor on the display
- the hoop will be moved until the needle is in the center of the motif
- touch symbol again
- on the display the first stitch of the motif will be marked again by the cursor



Motif Size

- display of motif width and height in mm

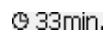

Embroidery Time

- display in minutes of the total embroidery time of the motif selected



Color Numbers

- display of the motif color numbers
- touch symbol
- the Color Motif display appears (the display closes by touching the symbol again)



Color Motif Display

- the color sequence can be scrolled with the arrows
- the display of the selected color is indicated in the Color Information bar as well as on the screen
- touch the Color Information bar
- the screen «Change Color/Brand to» appears
- the current thread color or brand can be changed



Zoom

- touch symbol
- the size of the embroidery motif is altered so that the complete design is visible without restrictions
- touch symbol again
- reverts motif back to original size



Show Grid

- touch symbol
- a large cross hair indicates the hoop center
- touch symbol again
- because the grid is now visible the motif can be positioned more accurately
- touch symbol again and the grid is switched off



Retrieve

- this function appears only when combining designs
- touch symbol
- switches between motifs when combining designs
- active motif is shown in color
- depending on how many times the function was touched, a motif or motif combination is shown active



Embroidery Menu

- touch «OK»
- the display changes from the Edit 1 or Edit 2 screen to the screen «Embroidery Menu»
- the motif is ready for embroidery

Edit 1 Screen



Add Motif

- touch «Add Motif»
- the overview of the last opened function (Alphabets, Motifs, My Design) appears
- select new motif or lettering of your choice or close display with «ESC»
- motif is added to motif on screen



New Motif

- touch «New Motif»
- the overview of the last opened function (Alphabets, Motifs, My Design) appears
- select new motif or close display with «ESC»



Delete

- this function only appears when combining designs
- touch symbol
- deletes the activated motif, the next one appears in color



Save

- touch symbol
- the «Save» screen appears

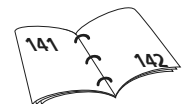

To Next Page - Edit 2

- touch symbol
- the Edit 1 screen changes to the Edit 2 screen

Edit 2 Screen



Rescale Motif Proportionally

- touch symbol
- the blue knob icon for operating the stitch width knob appears
- to enlarge the motif turn stitch width knob clockwise
- to reduce the motif turn stitch width knob counter clockwise
- display of the alteration in percent (%)
- to reactivate the basic setting (100%) of the motif touch the blue knob icon



Rotate Motif

- touch symbol
- the blue knob icon for operating the stitch width knob appears
- to rotate the motif clockwise, turn stitch width knob clockwise
- to rotate the motif counter clockwise, turn the stitch width knob counter clockwise
- display of the position in degrees (°)
- to reactivate the basic setting (0°/360°) touch the blue knob icon
- touch «rotate motif» several times and rotate motif clockwise in 90° steps (0°/90°/180°/270°/360°)



Move Motif

- touch symbol
- the blue knob icons for operating the stitch width and length knob appear
- to move the motif horizontally, turn the stitch width knob - to move right turn knob clockwise - to move left turn knob counter clockwise
- to move the motif vertically, turn the stitch length knob - to move up, turn knob clockwise - to move down, turn knob counter clockwise
- in the blue knob icon the alteration is displayed in 1/10 millimeter (mm)
- to move the motif diagonally turn the stitch width and length knob (the number in both blue knob icons is the same)
- to re-center the motif touch the blue knob icon or touch «Move Motif» again



Horizontal Mirror Image (left/right)

- touch symbol
- the motif will be mirrored horizontally (left/right)



To Next Page - Edit 1

- touch symbol
- the screen Edit 1 appears

Embroidery Menu



In the Embroidery menu the motif can be embroidered and embroidery related alterations made (e.g. single color / multi color).



Hoop Display

- display of the attached embroidery hoop with stitch field dimensions in mm



Hoop Relocator

- this function makes threading easier if the thread has to be changed when the needle is very close to the left edge of the hoop
- touch symbol
- the hoop moves horizontally to the center
- rethread
- touch «ESC»
- the hoop moves back to the previous position
- touch the Start / Stop - button and the embroidery computer continues to embroider

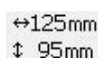

Motif Size

- display of the motif width and height in millimeters (mm)



Edit 1 Screen

- touch symbol
- the screen changes from the Embroidery menu to the Edit 1 screen

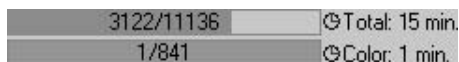

Embroidery Time

- display of the total (and remaining) embroidery time of the motifs on the upper bar
- display of the embroidery time of the active color in the lower bar
- stitch time on both bars counts down as embroidery progresses
- Number in upper bar:
 - the left number indicates how many stitches there are in the active motif/motif combination
 - the right number indicates the total stitch count of the active motif/motif combination
- Number in lower bar:
 - the left number indicates how many stitches there are in the active color
 - the right number indicates the total stitch count of the active color



Color Information Bar

- information on the current thread color:
 - display of the current thread color
 - position of the current thread color (1st number)
 - number of colors in the design (2nd number)
 - color number of the selected thread brand
- right and left arrow change the current thread color
- the hoop moves to first stitch of current thread color
- the current (active) color can also be individually embroidered by touching the Color Information bar



Single/Multi Color Motif

- touch symbol
- if the symbol is active, the complete motif will be embroidered in one color (without stopping)
- if the symbol is inactive, the colors will be embroidered individually



Embroidery Sequence Control (i.e. thread breakage)

- touch symbol
- a special screen appears
- in the left portion of the screen the motif appears in its original size
- in the right portion of the screen the motif appears in its enlarged size
- the embroidery sequence can be better controlled
- an Information Area for operating the stitch width and stitch length knob is displayed
- to check the embroidery sequence of the motif in stages turn stitch width knob
- the needle follows the embroidery sequence in individual steps
- by turning the stitch length knob the needle follows the embroidery sequence in big steps (approx. 50 steps)
- to follow the embroidery sequence forwards, turn the stitch width / stitch length knob clockwise
- to follow the embroidery sequence backwards, turn the stitch width / stitch length knob counter clockwise
- the number in the Information Area shows the stitch count of the embroidery sequence
- to reactivate the basic setting touch the blue knob icon
- touch «ESC» and the special screen will close

External Functions



Starting Embroidery With the Start-Stop-Button on Head Frame

- press the Start-Stop-button on head frame to start embroidery

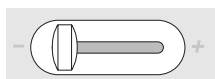

Slide Speed Control

- the motor speed can be freely adjusted with the slide



Stitch Width / Stitch Length Knobs

- with different functions such as Alter Size, Rotate Motif, etc. the external knobs are used to work on the motifs



- an Information Area appears when the knobs can be utilized



Embroidery Mode/ Sewing Mode Button

- changing from Embroidery Mode to Sewing Mode and vice versa

Motifs

All motifs can be either embroidered directly or can be combined with the different functions offered by the embroidery computer.

Apart from combining designs, it is also possible to rotate the motifs, to allocate another thread color, etc.

Basic Information on Embroidering Motifs With no Alterations

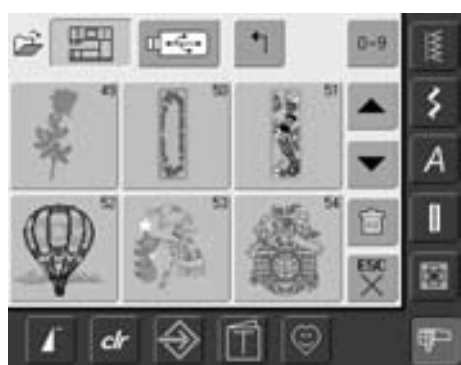

Motif Overview

- select desired motif in the Motif Overview

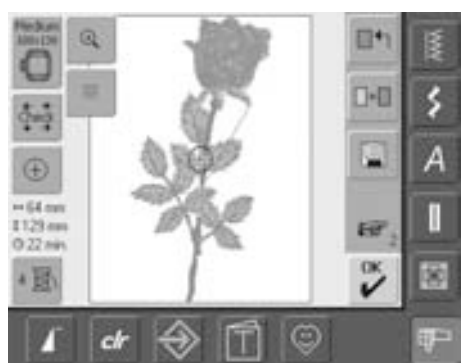

Select Hoop

The most appropriate (smallest possible) hoop is automatically chosen for the selected embroidery motif:

- the motif is shown on the display in the center of the most appropriate hoop
- «Select Hoop» also shows the most appropriate hoop

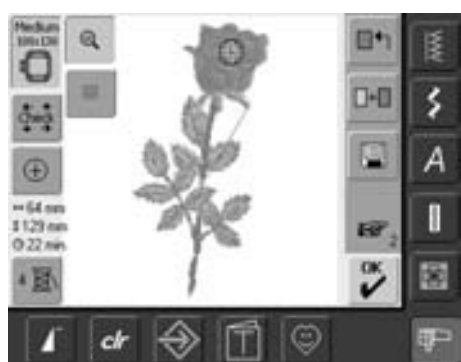

View Motif in Detail (Zoom)

A detailed viewing of the motif is possible with the Zoom function:

- touch symbol
- the size of the embroidery motif is altered so that the complete design is visible without restrictions
- touch symbol again
- the motif is reverted to its original size



Embroidering Motif

To change to the Embroidery menu touch «OK» in the Edit 1 or Edit 2 screen or the Start-Stop button on the head frame

- the motif can be embroidered by pressing the Start-Stop-button



Hoop Relocater

- this function makes threading easier when the needle is very close to the left edge of the hoop
- touch symbol and the hoop will move horizontally to the center, which makes threading easier

Positioning Motif

Positioning Motif in Desired Location

By moving or rotating the motif can be moved to another position within the hoop.

Preparation

- select desired motif from the Selection menu
- the motif appears in the Edit 1 screen
- use the «To Next Page» symbol to change to the Edit 2 screen



Move Motif



If the knobs are turned slowly the motif can be moved step by step (step length = 1/10mm).

- touch symbol
- the Information Areas for operating the stitch width and length knob appear
- to move the motif horizontally turn the stitch width knob
- in the Information Area the alteration is displayed in 1/10 mm
- to move the motif vertically turn the stitch length knob
- in the Information Area the alteration is displayed in 1/10 mm
- to move the motif diagonally turn the stitch width and length knob
- the motif is moved diagonally when the same number appears in both Information Areas
- to move the motif back to the middle touch the Information Areas or touch «Move Motif» again
- if a stitch of a motif is positioned outside the stitch area, the outline of the hoop is displayed in red



Rotate Motif



If the knobs are turned slowly the motif can be moved in 1° steps.

- touch symbol
- the Information Area for operating the stitch width knob appears
- to rotate the motif clockwise turn stitch width knob clockwise
- in the Information Area the position is shown in degrees (°)
- to rotate the motif counter clockwise turn the stitch width knob counter clockwise
- in the Information Area the position is shown in degrees (°)
- to reactivate the basic setting (0°/360°) touch the blue knob icon
- touch «Rotate Motif» several times and the motif is rotated clockwise in 90° steps (0°/90°/180°/270°/360°)

Checking the Motif Position

With the functions «Check» and «Motif Center» the motif position can be checked before embroidering.



Check

The function «Check» reads the attached hoop size and stitching area:

- touch symbol
- the hoop size is read causing the hoop to move
- «Check» moves hoop with the 4 arrows so that stitching area of selected motif can be confirmed
- if no hoop or a too small hoop was attached, an error message will appear



Checking Motif Center

- touch symbol
- the exact center of the motif is indicated on the display
- the hoop will be moved until the needle is in the center of the motif
- touch symbol again and on the display the first stitch of the motif will be marked once more

Altering Motifs

Mirroring Motifs

Each motif can be mirrored left/right.

Preparation

- select desired motif from the Selection menu
- motif appears in the Edit 1 screen
- use the «To Next Page» symbol to change to the Edit 2 screen



Mirroring Motifs Horizontally (left/right)

- touch symbol «Horizontal Mirror Image (left/right)»
- the motif will be mirrored horizontally

Altering Motif Size

Each motif can be proportionally enlarged or reduced.

Preparation

- select desired motif from the Selection menu
- the motif appears in the Edit 1 screen
- use the «To Next Page» symbol to change to the Edit 2 screen



Enlarging or Reducing Motif Proportionally

- touch symbol
- the Information Area for operating the stitch width knob appears
- to enlarge the motif turn stitch width knob clockwise
- to reduce the motif turn stitch width knob counter clockwise



Rotating mirrored motifs

A wonderful variety of combinations are possible together with the function «Rotate Motif».



Combining designs

If mirrored and unmirrored designs are combined, particularly attractive effects and borders can be designed.



For best results, the motifs should be scaled within the limits of 75% to 150%.

If the knob is turned slowly the motif size can be altered in 1% steps.



Bernina's scalable embroidery designs are the most flexible in the embroidery market. Bernina's stitch process engines add correct density in the majority of sizes and positions. However, since there might be an occasion when a certain percentage of scaling or rotation does not produce a 100% perfect recreation of the design, it is a good idea to test-sew your edited size and/or position of the design before you embroider your final product.

Display of the Motif Size

↔ 47mm
 ↓ 152mm

The motif width and height is displayed in millimeters (mm).

Selecting the Most Appropriate Hoop for Adjusted Motif Size

The most appropriate hoop should be chosen for the motif size:



- touch «Select Hoop»
- a special screen appears with possible choices of hoops
- by selecting a hoop (Small, Middle, Large Oval or Mega) the motif is shown in the appropriate hoop after the special screen closes

Combining Motifs

Motifs can be combined as desired with the embroidery computer to create completely new designs. A combination can consist of several identical motifs or of different ones. It is also possible to combine motifs with lettering.

Application

- combining motif variations
- creating new designs
- embroidering borders
- creating logos, crests, badges, labels, etc.

Preparation

- select desired motif from the Selection menu
- the motif appears in the Edit 1 screen

Creating Combinations



Adding Another Motif

With the function «Add Motif» another motif or letter from the selection menu is added to the existing one:

- touch «Add Motif»
- the summary of the last opened on-screen button («Alphabets», «Motifs» and «My Designs») appears
- select desired embroidery motif or change to the Selection menu with the arrow «Return to Selection menu»
- select desired field, e.g. lettering, in the Selection menu

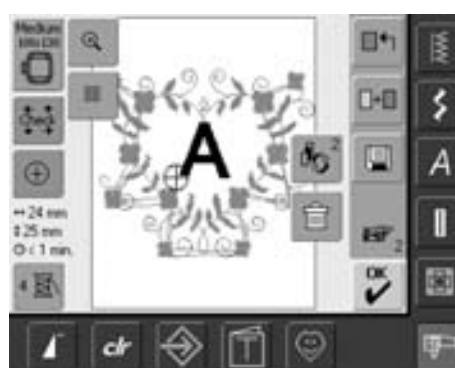

- when rescaling, in order to obtain an optimal embroidery result, all motifs in a combination should be the same size in percentage
- when rescaling within a 90% to 120% range, the size will be adjusted accordingly (without recalculation of stitches)
- when rescaling under 90% or over 120%, the stitches will be recalculated

Creating Motif Combination

With functions such as «Move Motif», «Rotate Motif» «Mirror Image», etc. the motif combination can be created as desired.



Selecting Motif Within the Motif Combination



- touch the symbol «Retrieve» once or more
- switches between different motifs when combining designs
- active motif is shown in color
- touch «Retrieve» until the desired motif is activated



Creating / Altering Motif Combination

- use the «To Next Page» symbol to change to the Edit 2 screen and create combination by altering the active motif (= in color):
- with «Move Motif» move the motif to the desired position
- in addition other alterations are possible: scaling, rotating, mirroring, etc.
- the screen displays all changes directly
- to alter another motif of the motif combination, activate the desired motif with «Retrieve»
- alter selected motif as desired

Depending on how many times the symbol was touched, one motif or the complete motif combination is active.



If the indicated hoop offers too little space, select a larger one with the function «Select Hoop».



Deleting Motifs

- touch the symbol «Retrieve» in the Edit 1 or Edit 2 screen once or more until the desired motif is activated (in color)
- touch «Delete» and the activated motif will be automatically deleted

Alphabets - Lettering

Letters can be combined with other letters or motifs and embroidered with the embroidery computer.

Application

- names, monograms and addresses
- words and text
- creating logos, crests, badges, labels, etc.
- labeling quilts (quilt labels)



Combining Letters

- select desired alphabet from the Selection menu
- a special screen with a keyboard appears
- the «ABC» on-screen button (upper case) is automatically active
- in the special screen there are different functions which take you to the appropriate lettering:
 - the «ABC» on-screen button changes to upper case
 - the «abc» on-screen button changes to lower case
 - function «Special Capital Letters»
 - function «Special Small Letters»
 - function «Numbers»
 - function «Special Characters»
- select desired letters
- spaces can be added by touching the bar below the keyboard
- the letters appear in the Text bar

Correcting Letters

- to delete individual letters touch the arrow on the right of the Text bar
- letters are deleted from right to left
- to delete letters touch the Text bar

Confirming Letters

- confirm combined letters with «OK» and the letters appear in the Edit 1 screen

Embroidering Letters With or Without Alterations

The combined letters are ready to be embroidered or can be altered with the different functions as desired.



If your edited lettering does not fit in the hoop, rotate lettering by 90° (a large number of letters can fit into the lengthwise stitch area of the hoop). Should this not be of any help then change size of lettering or reduce number.

Altering Lettering

The letters are altered in the Edit 2 screen:



Mirroring Lettering



- touch symbol «Horizontal Mirror Image (left/right)» and the motif will be mirrored horizontally



Enlarging or Reducing Lettering Proportionally



- touch symbol and the Information Area for operating the stitch width knob appears
- to enlarge the motif turn stitch width knob clockwise
- to reduce the motif turn stitch width knob counter clockwise
- in the Information Area the alteration is displayed in percent
- to reactivate the basic setting (100%) of the motif touch the Information Area

Selecting the Most Appropriate Hoop for Adjusted Motif Size



The best embroidery results are achieved by selecting the most appropriate hoop for the motif size.

Combining Lettering

Letters (for example words) can be combined with other letters or motifs.

Combining Different Words

The words (for example Nothing Sews Like A Bernina. Nothing.) are put together by the line and positioned individually:

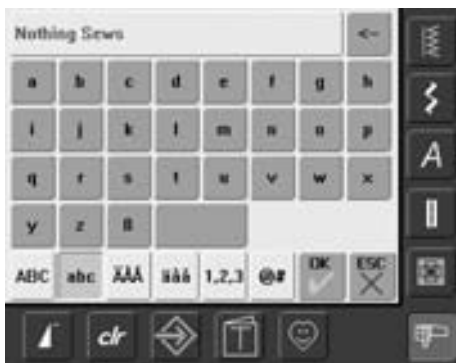

Putting Together the First Text Line

- select desired alphabet type from the Selection menu
- a special screen with a keyboard appears
- enter for example «Nothing Sews»
- select letters by using the Upper Case/Lower Case button and touch the bar below the keyboard to insert spaces where needed
- confirm combined letters with «OK» and the letters appear in the Edit 1 screen
- use the «To Next Page» symbol to change to Edit 2 screen



Positioning First Text Line

- select large hoop (Large Oval) with the function «Hoop Select»
- rotate text by 90° (more space for text in hoop) with the Rotate Motif function
- position text with the function «Move Motif»
- if a stitch of a motif is positioned outside the stitch area, the outline of the hoop is displayed in red



Combining and Positioning Further Text Lines

- select «Add Motif» in the Edit 1 screen
- further text lines will also be combined and positioned individually as described above
- to determine equal spacing between lines, pay attention to the numbers in the blue knob icon function «Move Motif» when positioning text lines



Combining Motifs and Lettering

After selecting a motif the lettering is added according to the work at hand, or the lettering is created first and the motif added afterwards (e.g. embellished text).



Combining Example



- select desired motif in the embroidery computer
- the motif appears in the the Edit 1 screen
- select «Add Motif» in the Edit 1 screen
- select desired alphabet type from the Selection menu
- a special screen with keyboard appears
- enter text (e.g. «Flowers»)
- select lettering using Upper Case/Lower Case button

- confirm combined lettering with «OK» and the lettering is displayed in the Edit 1 screen above the motif



Altering Text to Suit Motif

- use the «To Next Page» symbol to change to Edit 2 screen
- position the text as desired with the function «Move Motif»
- alter text size to suit motif with the function «Rescale Motif Proportionally»

Motif Colors

The motif colors can be changed as well as embroidered in different ways.

Preparation

- select desired motif from the Selection menu
- the motif is displayed in the Edit 1 screen

Reallocating Motif Colors

- touch the function «Color Number» in the Edit 1 or Edit 2 screen
- the Color Motif display opens
- following information is available: display of current color, current color position (first number), number of all colors (second number) and color number of chosen thread brand
- scroll with the arrows until the color to be changed appears
- touch Color Information bar



- a special screen for changing the current thread color appears
- to change the thread brand scroll with the arrows next to the color brand, until the desired brand appears
- touch «Thread Brand» = the screen changes and the altered thread brand with the corresponding color information is displayed in the Color Information bar
- to change the thread color scroll with the arrows next to the thread color, until the desired color appears, then touch Color bar
- the screen changes and the altered thread color is display in the Color Information bar

0-9



For a quick selection of a certain color number, use the function «Color Selection by Number».



Embroidering Motifs in One Color



- touch the Single/Multi Color Motif symbol in the Embroidery menu
- Single/Multi Color Motif symbol is activated (highlighted in blue)
- embroidery computer stops only when motif is complete



Embroidering Lettering in Multi Colors



- lettering is embroidered in one color and the brush symbol is not visible
- to embroider each letter of a word or each word of a word combination in a different color, each letter or word must be programmed and placed separately
- the embroidery computer stops after each letter or word, the thread color can be changed
- the Embroidery Time is displayed for each color
- to embroider the complete lettering combination in one color, touch the Single/Multi Color Motif symbol now visible

Embroidering Individual Color Sections and Manual Adjustment of Color Sequence



- special effects can be acquired according to the motif, only when individual color sections are embroidered (e.g. embroider only the outlines of the motif)
- scroll Embroidery menu for color sequence until desired color area is displayed
- the needle is positioned to the start of the color sequence selected
- embroider color (embroidery computer stops automatically at the end of color)

Saving Motifs

Motifs from the embroidery computer, sticks, embroidery cards as well as motifs created in the BERNINA artista software, can be combined, rearranged, and altered in different ways, then saved.

Motifs can either be saved to the embroidery computer or on a stick (Personal Design Stick).

The embroidery computer has a memory system, i.e. both the sewing stitch combinations and embroidery motifs are saved in this system. Since the memory space is not sub-divided into fixed spaces, any desired number of motifs can be stored as long as enough free memory is still available. If there is not enough memory space, other motifs and/or stitch information must first be deleted.

In a saved stitch combination, individual stitches can be altered after being selected.



Motifs which have been altered in terms of size and saved, will be regarded as a new motif when subsequently selected. (That is why all percentages say 100%, and the original alteration(s) is/are no longer visible.)

Saving to the Embroidery Computer



- open desired motif from embroidery computer, personal design stick or peripheral source
- alter or combine motif if desired
- touch «Save» in the Edit 1 screen



- motif to be saved is displayed as «New» on left of screen
- the Embroidery Computer button from the Selection menu is activated
- the folder My Designs will open automatically
- the System Memory Capacity (Free Capacity) is shown in percentage (%) in the top right bar
- select motif to be saved
- the motif is now saved in the folder My Designs in numerical order
- the Edit 1 screen appears again

Saving to a BERNINA USB Stick



- personal design sticks are available as optional accessories from your BERNINA dealer
- open desired motif from embroidery computer, personal design stick or peripheral source
- alter or combine motif if desired
- touch «Save» in the Edit 1 screen



- motif to be saved is displayed as «New» on left side of screen
- insert personal design stick
- select the Stick button from the Selection menu
- the System Memory Capacity (Free Capacity) is shown in percentage (%) in the top right bar
- select the motif to be saved
- the motif is now saved on the personal design stick

Overwriting Motifs



- motifs saved in «My Designs» or on a personal design stick can be directly overwritten with a new motif
- open desired motif from embroidery computer, personal design stick or peripheral source
- alter or combine motif if desired
- touch «Save» in the Edit 1 screen



- motif to be saved is displayed as «New» on left of screen
- select the Stick button (personal design stick inserted) or Embroidery Computer button from the Selection menu
- touch the motif you wish to overwrite



- confirm the appearing animation with «OK»
- the motif is now saved in the place selected before

Deleting a Saved Motif



- select from the selection menu either «Memory Stick» (Memory Stick is inserted) or «Embroidery Computer» and select the folder «My Designs»
- touch «Delete»



- select the motif to be deleted in the screen visible now



- confirm the appearing animation with «OK»
- the motif is deleted
- cancel deleting with «ESC», the previous screen appears

Deleting All Saved Motifs

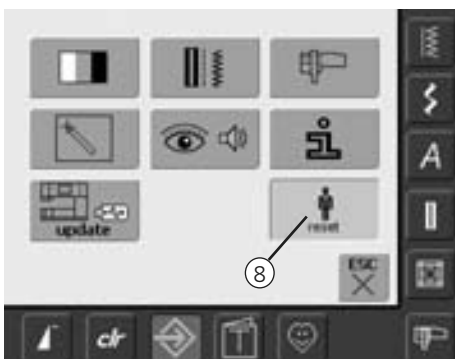

- it is possible to delete the content of a personal design stick or the folder «My Designs» all at once
- to delete the content of a personal design stick or the folder «My Designs», the Setup program must be opened
- touch «Setup»
- the Selection menu appears
- touch «8»
- a summary of the screen appears

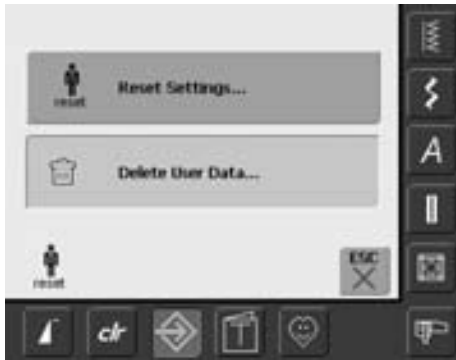

- touch «Delete User Data»

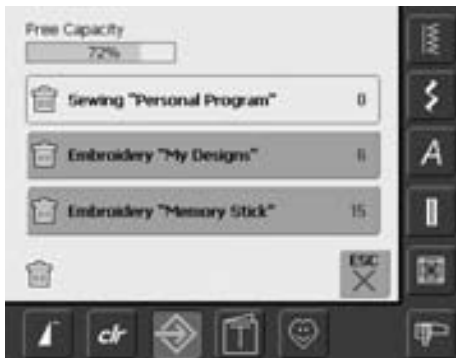

- in embroidery two choices are possible:
 - «My Designs»
 - «Memory Stick» (the stick must be plugged into the embroidery computer)
- touch the button of which the data should be deleted

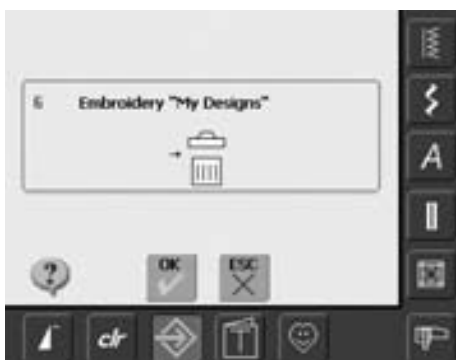

- confirm the appearing display message with «OK»
- the data is deleted and the screen reverts to the previous screen
- touch «ESC» until the last activated Embroidery screen appears

Tutorial



Opening Tutorial

- touch «Tutorial»
- a screen with subjects appears



Subjects

- select the desired subject, e.g. Embroidery Hoops

Embroidery Hoops

Preparation:

- select a hoop that is closest in size to the design being embroidered

Settings:

- One hoop comes with the embroidery module:
- Large: (oval) 145mm x 255mm

Suggestions for Success:

- Optional hoops available:
- Small: 72mm x 50mm for small designs or lettering
- Medium: 100mm x 130mm
- Mega Hoop: 150mm x 400mm for larger designs, featuring clamps for extra stability when embroidering large projects
- always use the hoop template to center your designs

End of Page



- Information on the desired subject appears



Text Scrolling

- this symbol indicates that text scrolling on screen can be activated with the stitch width or stitch length knob



Back to Subjects

- touch the «Home» symbol
- the first screen (Subjects) of Tutorial appears



Back to Previous Screen

- touch «ESC»
- Tutorial is closed
- the previous screen appears

Thread Breakage While Embroidering

It is possible that the upper thread may run out or break while embroidering. In this case the embroidery computer stops automatically provided that the upper thread sensors is activated.

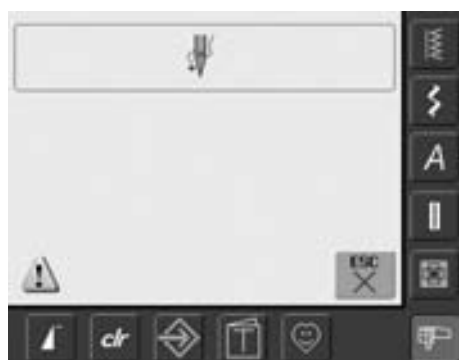

Upper Thread Breaks

- the embroidery computer stops automatically when the upper thread runs out or has broken
- a display message appears on the screen
- check upper and if necessary lower thread and rethread
- touch «ESC»
- to continue embroidering press the Start-Stop button

Lower Thread Runs Out

- the embroidery computer does not stop automatically when the lower thread runs out

Embroidery Sequence Control for Thread Breakage

- touch «Embroidery Sequence Control»
- a special screen appears
- in the left portion of the screen the motif appears in its original size
- in the right portion of the screen the motif appears in its enlarged size
- the embroidery sequence can be better controlled
- the Information Area for operating the stitch width and stitch length knob is displayed
- turn the knobs counter clockwise (or clockwise) to move the embroidery hoop backwards (or forwards) in the embroidery sequence
- turn the stitch width knob slowly to move the hoop stitch by stitch
- turn the stitch length knob to move the embroidery hoop in big steps (approx. 50 steps)
- the number in the Information Area shows the stitch count of the embroidery sequence
- go back stitch by stitch to a position several stitches before thread breakage occurred to resume stitching
- to reactivate the basic setting touch the blue knob icon
- touch «ESC» and the special screen will close

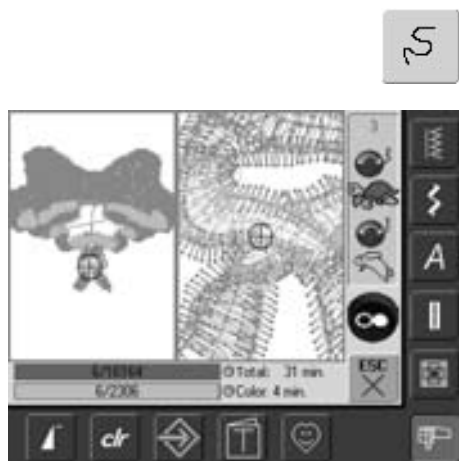

Resuming Embroidery

- press foot control or Start / Stop - button on head frame to resume stitching
- Embroidery screen reappears again
- complete motif

Prevention and Remedy of Failures

Note the following advice to recognize the causes of most of the operation failures in the embroidery computer that might occur.

Check First Whether:

- upper and lower threads are threaded correctly
- the needle is inserted correctly - flat part of the shank to the back
- the needle is the correct size (see Needle/Thread Chart on pages 16-18)
- the embroidery computer is clean - remove any thread lint
- the hook race is clean
- bits of thread are trapped between the tension disks and under the bobbin case spring

Removing Trapped Thread

If the lower thread breaks and the thread is trapped in the area of the take-up lever, proceed as follows:

- power switch to «0» (off)
- remove the screw on the head frame with the angular Torx key
- pull head frame to the left
- remove remnants of thread
- attach head frame and tighten screw

Upper Thread Breaks

Possible Faults:

- upper thread tension is too tight
- use of low quality needle. It is best to buy needles in a BERNINA store
- needle has been inserted incorrectly. The flat part of the shank must be to the back
- needle is blunt or bent
- use of poor quality thread, thread with knots, thread too old or dried out

Possible Solutions:

- attach foam pad
- use appropriate spool disc
- use net for even unwinding of thread (pull over upper thread spool)
- stitch plate hole or hook tip is damaged: take the embroidery computer to an authorized BERNINA dealer
- reduce embroidery speed

Lower Thread Breaks

- lower thread tension is too tight
- lower thread is trapped in the bobbin case:
 - Replace bobbin
- needle is blunt or bent
- the stitch plate hole has been damaged by the needle:
 - It must be polished by a BERNINA Technician

Skipped Stitches

- incorrect needle used:
 - Use only 130/705H needle system
- needle is bent or blunt or not correctly inserted:
 - Push all the way to the top when inserting
- low quality, badly polished needle used

Needle Breaks

- needle clamp screw is too loose
- defective stitch plate

Unsatisfactory Stitch Formation

- remnants of thread between tension discs:
 - pull folded thin fabric (use the fold, not an outer edge) back and forth between the tension disks to clean the left and right side of the thread tension
- remove any remnants of thread from under the bobbin case spring
- adjust thread tension
- used wrong or no stabilizer at all
- incorrectly threaded:
 - check upper and lower thread
- when embroidering, thread finger with lower thread
- use appropriate spool disc
- clean and oil hook (use original oiler only. See Cleaning and Lubricating on page 103)

Embroidery Computer Fails to Run or Runs Slowly

- plug not fully inserted
- power switch in «0» (off) position
- embroidery computer has been standing in a cold room

Defective Sewing Light

- take the embroidery computer to an authorized BERNINA dealer

Upper Thread Indicator Sensor

- not activated in the Setup Program

Calibration of the Display

To open the calibration screen directly, proceed as follows:

- press both needle position buttons on the body simultaneously and keep them pressed
- turn on the sewing and embroidery computer
- as soon as the calibration screen is opened, release the two buttons
- Calibration of the Display see page 96

Service Data

Service data of the actual condition of your sewing and embroidery computer can be saved on a USB stick and sent to your authorized BERNINA dealer:

- insert the USB stick into your sewing and embroidery computer
- press the «Setup» button and select the symbol «i» (information)
- use the «To Next Page» symbol to change to the previous screen
- touch «LOG»
- data is saved on the USB stick
- remove the USB stick







Update error

If the update process is at a still stand (hour glass remains) proceed as follows:

1. Remove the USB stick and turn off the Sewing/Embroidery computer
2. Turn on the Sewing/Embroidery computer and proceed with the update as indicated by a message on the display

Messages on the Screen

In special cases messages may appear on the screen. They serve as a reminder, warning, or confirmation of selected applications and functions.

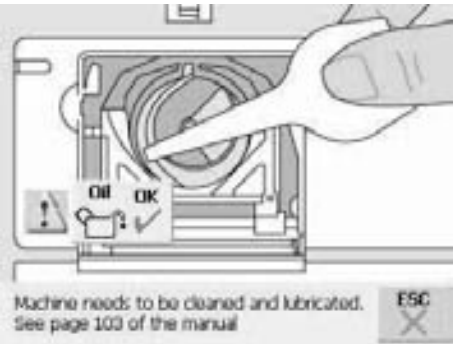
| Message | Notes |
|--|--|
|  Warning | <p>The user must do something, before the function can be carried out, or the user's attention will be drawn to a specific fact.</p> |
|  Query | <p>Does the user really want to carry out the function? For example delete data, etc.</p> |
|  Lower feed dog | <p>Press the button «Drop feed dog». The message disappears automatically if the feed dog position was changed.</p> |
|  Thread breakage or empty spool. | <p>Check upper thread and perhaps lower thread.</p> |
|  The winder is on. | <p>The winder speed can be changed with the stitch width knob or the «+» und «-» on-screen buttons. If the winder is turned off or «ESC» is pressed, the message disappears automatically.</p> |
|  Lower presser foot. | <p>The message disappears automatically if the presser foot was lowered.</p> |
|  Raise presser foot. | <p>The message disappears automatically if the presser foot was raised.</p> |
|  The embroidery computer must be cleaned / lubricated. | <p>Corresponding instructions are on page 103 of the manual. This notification will appear after approx. 180,000 stitches. After cleaning/oiling clear the display by touching «OK». The display can be cleared temporarily by touching «ESC», but will appear again when restarting the sewing computer. After clearing with «ESC» for the third time, the cleaning notification will only appear again after a further approx. 180,000 stitches.</p> |



Service Notification

The sewing computer must be taken for a service to a BERNINA dealer. The notification will appear after approx. 2,000,000 stitches. If the service was done by the BERNINA dealer, the stitch counter will be on «0» again and the display does not appear anymore. The display can be cleared temporarily by touching «ESC», but will appear again when restarting the sewing computer. After clearing with «ESC» for the third time, the notification will appear again at approx. 4,000,000 stitches.



Set feed dog on «Sewing»

Press the button «Drop feed dog». The message disappears automatically if the feed dog position was changed.

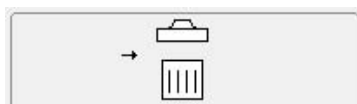

Deleting or overwriting data , e.g. Drawers.

Confirm with «OK» or cancel with «ESC».



Change the needle to the highest position.

Turn the hand wheel and put the needle in the highest position.

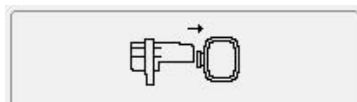

Remove embroidery hoop.

Remove embroidery hoop from embroidery module.

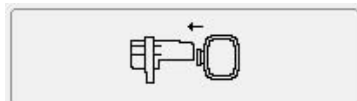

Attach embroidery hoop.

Attach embroidery hoop to embroidery module.



Attach Embroidery foot No. 26. Thread bobbin case

Attach Embroidery foot No. 26 to the embroidery computer. For embroidery thread the lower thread in the finger of the bobbin case

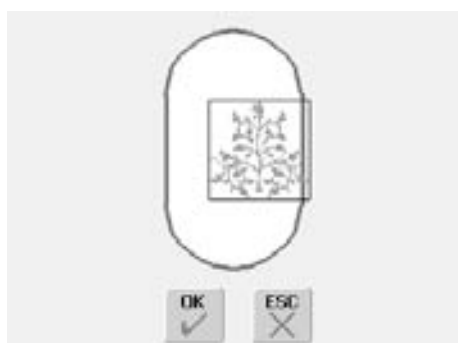

Design is not completely inside the hoop.

Position the design inside the hoop.

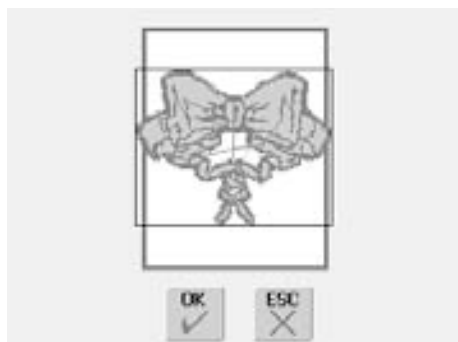

Motif does not fit into the attached hoop

Attach a larger embroidery hoop or reduce the size of the motif

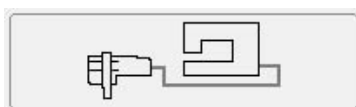

No embroidery module is attached.

Attach embroidery module to the embroidery computer.

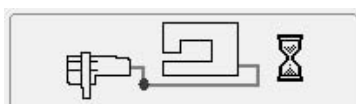

Data transfer

As soon as the data transfer is completed, the message will disappear and the selected function will be carried out.

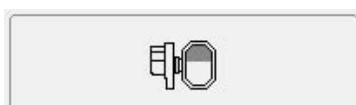

Mega-Hoop up

Move the Mega-Hoop to Upper (1) position.



Mega-Hoop center

Move the Mega-Hoop to Middle (2) position.



Mega-Hoop down

Move the Mega-Hoop to Lower (3) position.

Main Motor failed. Check hook system.

Remove any remnants of thread from the hook area/bobbin case.

Accessories

BERNINA offers a variety of extras (optional accessories) to go with the sewing and embroidery system artista 630, for new and unlimited opportunities. Ask your BERNINA dealer for more information.

Suitcase System



Thanks to the suitcase system with integrated wheels especially developed for the sewing and embroidery computer, you will be able to carry the latter with particular ease and elegance.

The case houses both standard and optional accessories in conveniently arranged compartments and bags.



When travelling by plane, coach or train, the suitcase system must be transported as carry-on luggage only! The suitcase system must not be transported as normal luggage!



The suitcase system protects the computers from dust and dirt, as well as humidity, for short distances.



Suitcase for Sewing Computer

- simply remove bags and compartments to place the sewing computer in the suitcase for storage (screen faces front)
- load compartments and bags with standard accessories and replace
- the bags provide space for additional optional accessories



Suitcase for Embroidery Computer

- simply remove bags and compartments to place the embroidery module in the suitcase for storage (embroidery arm faces front)
- load compartments and bags with standard accessories and replace
- the bags provide space for additional optional accessories

Embroidery Mega-Hoop



Use the embroidery Mega-Hoop to stitch extra large motifs, large design combinations, or long borders with ease.

With the Mega-Hoop three embroidery positions are possible. If the Mega-Hoop has been repositioned, the embroidery computer stops and a message indicates, to which embroidery position (top, center or bottom) the Mega-Hoop has to be moved. For artista 630 use the template named VAR. 01



The embroidery Mega-Hoop includes user instructions!

Embroidery Sticks



1 Embroidery stick



In addition to the preprogrammed OESD embroidery sticks available as a supplement to the designs already in the embroidery computer, there are «empty» BERNINA personal design sticks available to save embroidery designs or embroidery design combinations.

The preprogrammed OESD embroidery sticks contain a number of embroidery designs on a specific theme. The subject areas are continually supplemented and extended. You will find a large selection under www.embroideryonline.com or at your authorized BERNINA dealer.

Inserting Embroidery Stick

- plug design stick into the connection provided on the right hand side of the embroidery computer (look for symbol)
- designs (only from the folder 630) can now be opened and displayed on screen
- if a folder with an other name is opened, an empty screen will appear
- touch the «Arrow» symbol = return to Selection Menu

Removing Embroidery Sticks

- pull embroidery stick out

BERNINA artista Embroidery Software



2 PC Connection



Use the BERNINA artista PC software to combine, extend, and change existing motifs on a personal computer (PC). The software even allows you to create motifs all on your own. The whole design process lies in your hands: from first draft, to final transformation into embroidery stitching, the choices are all yours!

The finished designs you have created are transferred via a USB connecting cable directly to the embroidery computer, where you can embroider them. The USB connecting cable comes with the embroidery module.

Plugging USB Connecting Cable from the PC into the Embroidery Computer

- plug USB connecting cable into socket provided on the right hand side of embroidery computer (look for symbol)

Embroidery Design (PC) Saving Options

- on PC
- on artista 630 embroidery computer
- on a personal design stick



Warning:
After data transfer from the PC to the Embroidery computer or vice versa has been completed, the USB connection cable **MUST BE** removed from the Embroidery computer.



The BERNINA artista embroidery software includes user instructions!

Ask your BERNINA dealer for other accessories for your embroidery computer!

Glossary

Add

- to add means to combine by addition, to join, to increase
- adding a new motif

auto

- for example in connection with sewing buttonholes:
- if the length is preprogrammed «auto» appears, i.e. the buttonhole is stitched in the programmed length automatically (by itself)

auto/repeat

- to repeat means to redo, hence auto repeat redoing something by itself
- keeping the external needle position button pressed leads to rapid automatic moving of the needle position (by itself)

Balance

- to balance a stitch or motif means to alter a stitch to correct distortions

Calibrate

- to calibrate, to gauge, to measure
- calibrating means determining measures, setting the screen

Check

- to check, to examine, to inspect
- when embroidering, the computer checks which embroidery hoop is mounted, and «travels» the fabric to check on the position of the motif

clr (clear)

- to clear, to delete
- functions or commands can be deleted and reset to the original position
- the active, altered stitch will be reset to the basic settings

Edit

- to edit, to write, to publish, to process a text, to prepare for printing
- motifs are edited on the screen (Edit 1 or Edit 2), for example mirrored, scaled, etc.)

ESC

- closing a function, going back to original position (e.g. to original screen settings)

manual

- a manual buttonhole is sewn in four or six steps (depending on the type of buttonhole). The sewer manually changes the positions on screen.

Mega-Hoop

- mega means very large, hoop means frame
- extra large embroidery hoop for stitching very large motifs or long borders

Memory

- memory, store
- programs and data are saved and prepared for processing
- the memory of the sewing and embroidery computer can be used to save e.g. stitch combinations or motifs

Menu

- summary, overview, selection of functions

New

- to save a new motif in the memory of the embroidery computer

OK

- confirming the command entered or change that has been made

PC

- Personal Computer

recording /counting

- to record, to preserve, to tape
- the stitch counter records or programs the number of stitches used
- the stitch counter records the stitched length in the darning program

Reset

- to set again, to put back, to restore
- a change made is undone, i.e. reset to the original settings

scroll

- to browse
- if a comprehensive file (e.g. Tutorial) cannot be displayed in full, the «scroll» tool can be used to display further sections on screen

Setup

- to determine, to begin
- structure
- in the Setup Program you can for example determine and adjust the factory settings to your personal requirements

Software

- generic term for programs (i.e. computer programs)
- as opposed to hardware, which is the term used to describe any physical or tangible components of a computer (e.g. the casing, motor, etc.)

Touch Screen

- sensor screen
- touch a button (with your finger or a touch pen) on screen rather than press a key on the keyboard

Tutorial

- self-help program for learning about various embroidery computer features

Update

- latest version
- updating the sewing and embroidery computer software: installing a newer or the latest version, or updating parts of a program

Upgrade

- to take to a higher level, to improve, to promote
- upgrading the sewing and embroidery computer means improving or extending its functions

USB

- Universal Serial Bus
- the sewing and embroidery computer provides for USB connections

Zoom

- to focus on, to enlarge, to rescale
- in the screen Edit 1 or Edit 2 a motif can be zoomed (zoomed in or zoomed out)

Stitch Summary

Practical Stitches

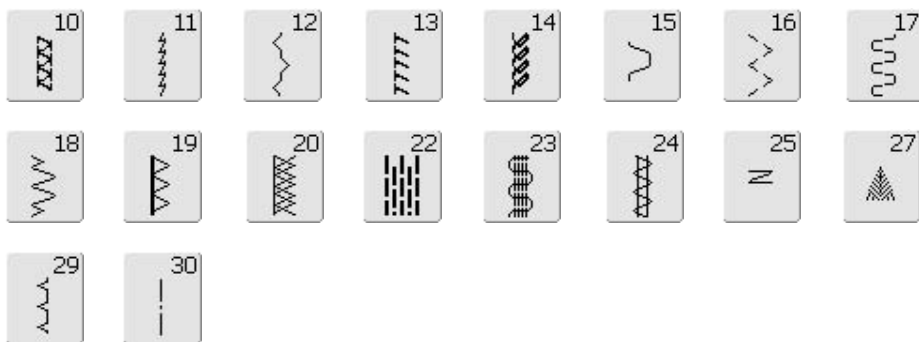

Buttonholes

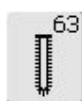

Decorative Stitches

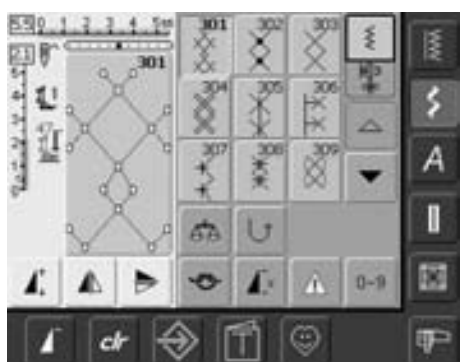
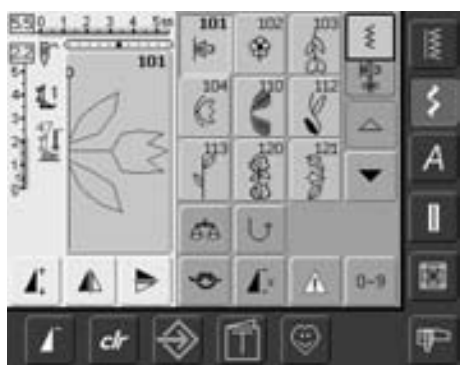

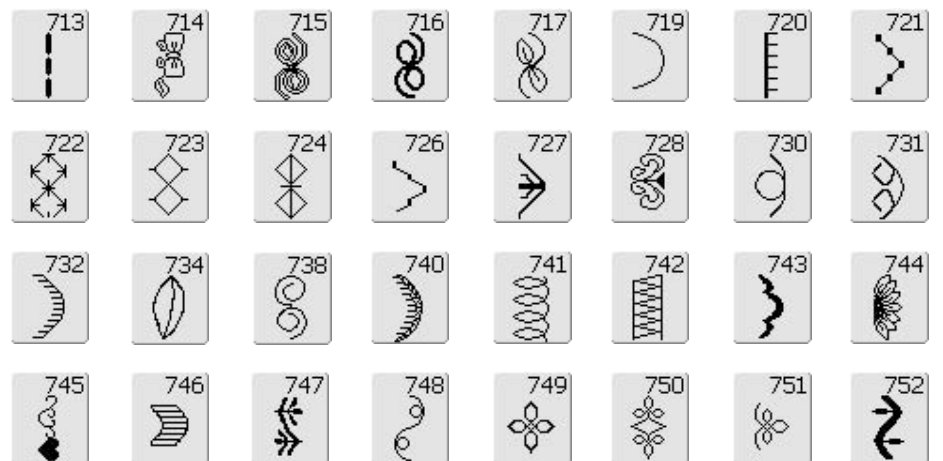
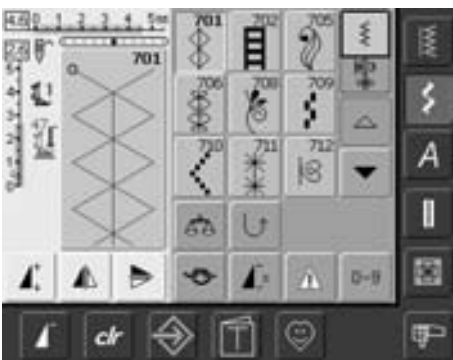
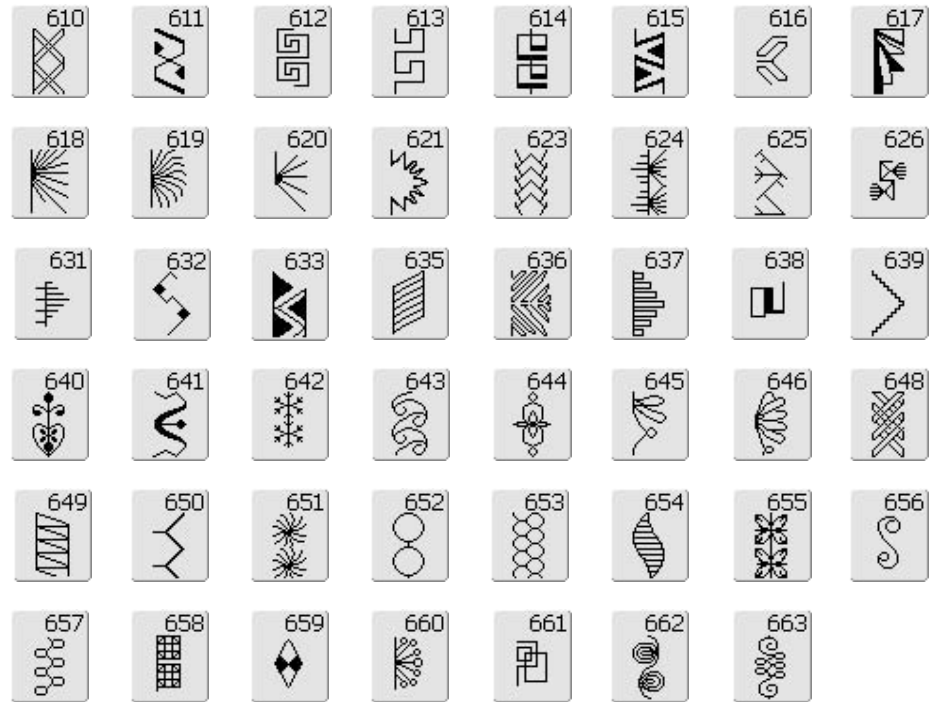
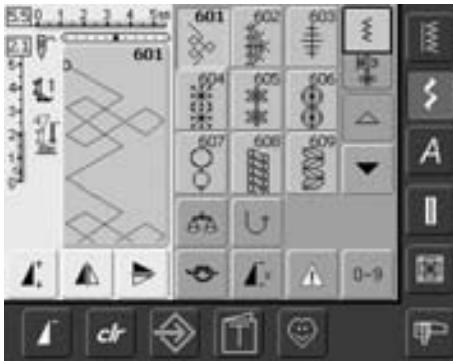
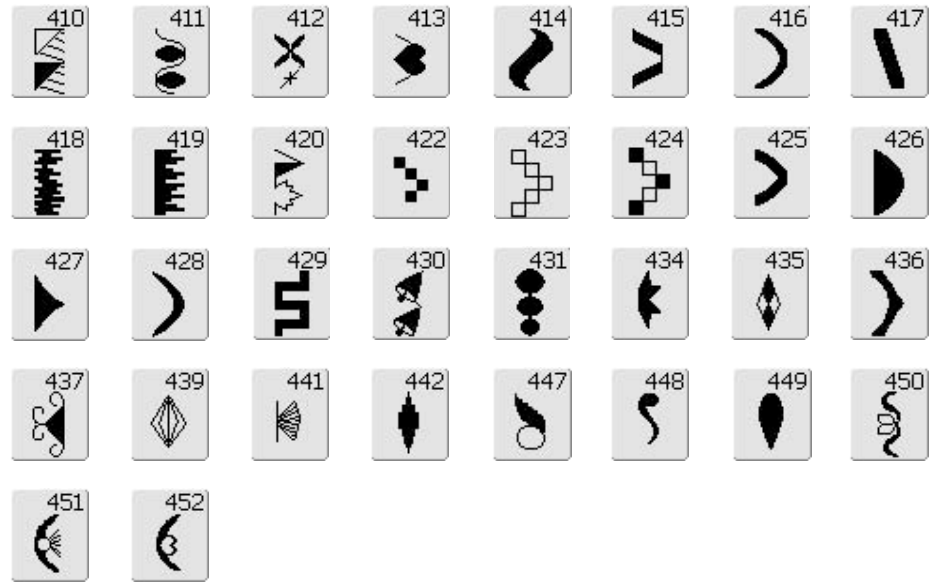

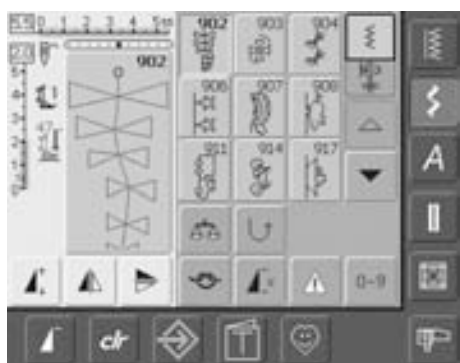

Quilt Stitches

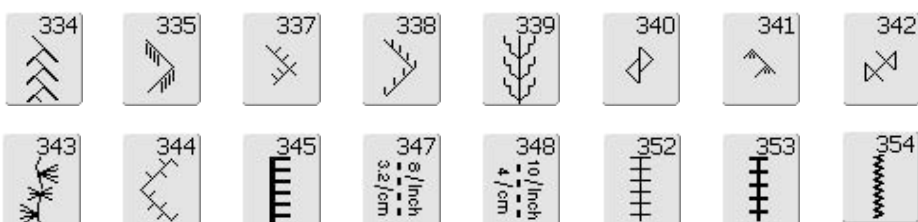

Alphabets

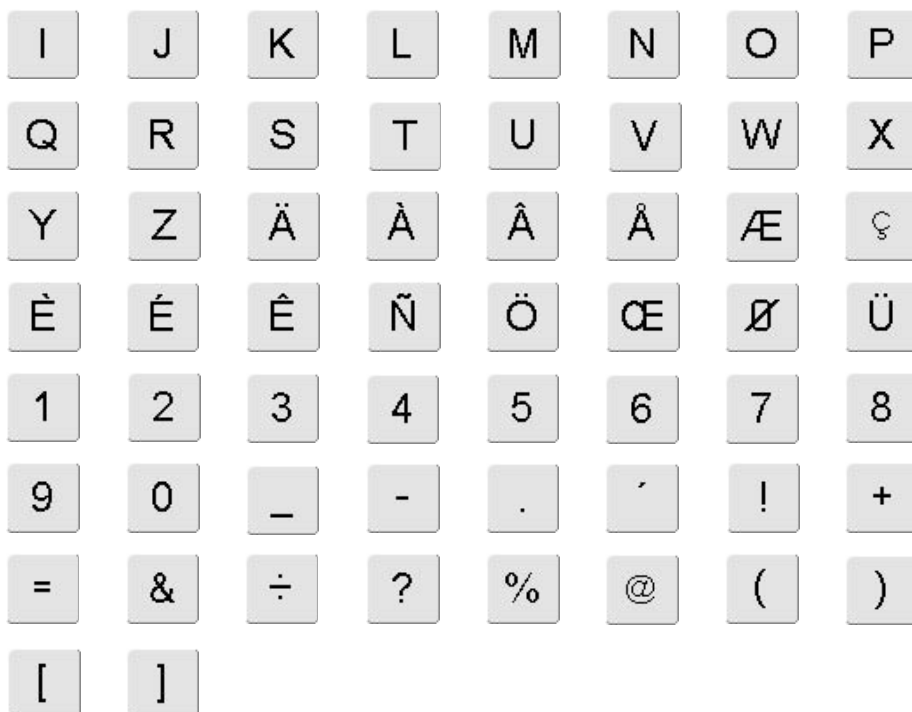

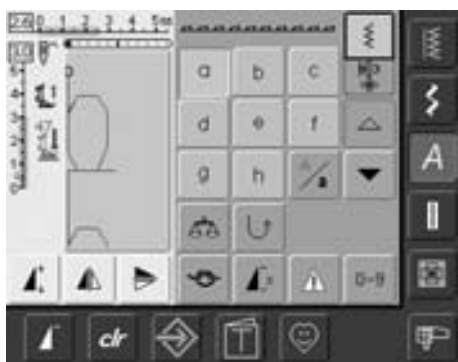

| | | | | | | | |
|---|---|---|---|---|---|---|---|
| i | j | k | l | m | n | o | p |
| q | r | s | t | u | v | w | x |
| y | z | ä | à | â | å | œ | ç |
| è | é | ê | ñ | ö | ø | ù | |

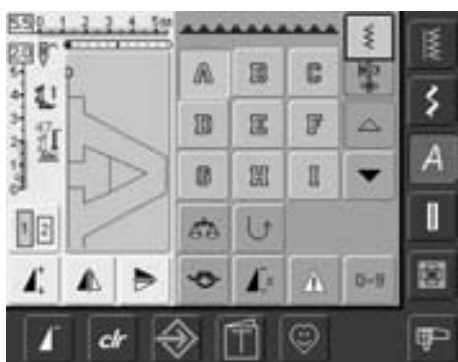

| | | | | | | | |
|---|---|---|---|---|---|---|---|
| J | K | L | M | N | O | P | Q |
| R | S | T | U | V | W | X | Y |
| Z | Ä | À | Â | Å | Æ | Ç | È |
| É | Ê | Ë | Ö | Ø | Ù | Ì | |
| 2 | 3 | 4 | 5 | 6 | 7 | 8 | 9 |
| 0 | - | ° | • | · | ! | + | = |
| & | ÷ | ? | % | @ | (|) | [|
|] | | | | | | | |

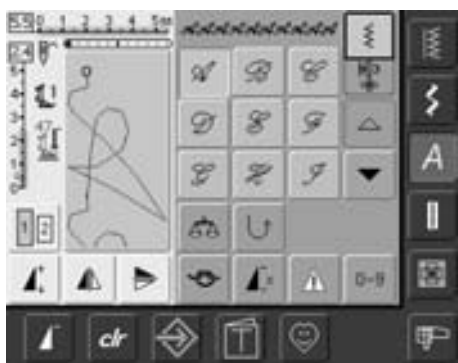

| | | | | | | | | |
|--------------|----------|----------|----------|----------|----------|----------|----------|----------|
| <i>I</i> | <i>J</i> | <i>K</i> | <i>L</i> | <i>M</i> | <i>N</i> | <i>O</i> | <i>P</i> | <i>Q</i> |
| <i>R</i> | <i>S</i> | <i>T</i> | <i>U</i> | <i>V</i> | <i>W</i> | <i>X</i> | <i>Y</i> | |
| <i>Z</i> | <i>Ä</i> | <i>À</i> | <i>Â</i> | <i>Å</i> | <i>Æ</i> | <i>Ç</i> | <i>È</i> | |
| <i>É</i> | <i>Ê</i> | <i>Ë</i> | <i>Ö</i> | <i>Ø</i> | <i>Ù</i> | <i>Ì</i> | | |
| <i>2</i> | <i>3</i> | <i>4</i> | <i>5</i> | <i>6</i> | <i>7</i> | <i>8</i> | <i>9</i> | |
| <i>0</i> | <i>-</i> | <i>°</i> | <i>•</i> | <i>·</i> | <i>!</i> | <i>+</i> | <i>=</i> | |
| <i>&</i> | <i>÷</i> | <i>?</i> | <i>%</i> | <i>@</i> | <i>(</i> | <i>)</i> | <i>[</i> | |
| <i>]</i> | | | | | | | | |

Index

- A**
- Accessories** 152-154
 - artista Embroidery Software 154
 - Embroidery Mega-Hoop 153
 - Embroidery Sticks 153
 - Suitcase System 152
 - Accessory Box** 4
 - Accessories Embroidery** 110-111
 - Accessories Sewing** 4-5
 - Alphabets, Lettering for Embroidery** 135-138
 - Altering Lettering 136
 - Combining Lettering 137
 - Combining Letters 135
 - Combining Motifs and Lettering 138
 - Correcting Letters 135
 - Alphabets, Letters for Sewing** 59-61
 - Change Size 61
 - Combining Lettering 60
 - Combining Lettering and Functions 61
 - Correcting Combinations 60
 - Selecting 59
 - Selecting Lower Case 61
 - Summary 59
 - Altering Motifs** 132-133
 - Altering Stitch Length** 23
 - Altering Stitch Width** 23
 - Attaching the Embroidery Module** 112
- B**
- Balance** 102
 - Basting Stitch** 53
 - Blind Hem** 50
 - Bobbin Case: removing/inserting** 10
 - Bobbin Thread Cutter** 10
 - Bringing up the Lower Thread** 12
 - BSR Freehand Quilting** 80-83
 - Buttonholes** 62-75
 - Automatic Buttonhole with Direct Entry Length or Button Measuring on Screen 69
 - Balance for Buttonholes 68
 - Buttonhole in Long Term Memory 73
 - Buttonhole Program Functions 63
 - Buttonholes Summary 62
 - Buttonholes with Cord 65-67
 - Cutting Buttonholes open 67
 - Important Information 64-65
 - In General 62
 - Manual 4 or 6 Step Buttonholes 74
 - Sewing Hand-look Buttonhole 72
 - Sewing Round and Keyhole Buttonholes 71
 - Sewing Standard and Stretch Buttonholes 70
 - Straight Stitch Buttonhole 75
 - Button Sew-on Program** 75-76
- C**
- Carrier Bag** 4
 - CFL Sewing Light** 15
 - Changing the Needle** 13
 - Changing the Presser Foot** 19
 - Cleaning** 103
 - Combining Motifs** 133-134
 - Connecting the Adapter for Free Arm Embroidery** 113
 - Contents** 3
- D**
- Darning Program** 42
 - Decorative Stitches** 54-58
 - Applications 54-55
 - Combining Decorative Stitches and Functions 56-57
 - Decorative Stitches in the Combi Mode 58
 - Selecting 54
 - Details of the Embroidery Module** 109
 - Details of the Sewing Computer** 6-7
 - Different Stitch Types** 118
 - Fancy-Fill Stitches 118
 - Jump Stitches 118
 - Outline Stitches 118
 - Satin Stitch 118
 - Step Stitch 118
 - Underlay Stitches 118
 - Double Overlock Seam** 45
- E**
- Edgestitching** 40
 - Embroidery Motifs** 129-130
 - Embroidery Stabilizers** 116-117
 - Embroidery Test** 117
 - Embroidery Threads** 119
 - External Function Buttons**
 - Altering Needle Position 29
 - Needle Up/Down 29
 - Pattern End 29
 - Quick Reverse Button on Head Frame 29
 - Securing Function 29
 - Slide Speed Control 29, 128
 - Start-Stop Button 29, 128
- F**
- Fabric, Needle, Thread** 16
 - Feed Dog**
 - Feed Dog and Fabric Feed 20-21
 - Feed Dog Up/Down 20
 - Lowered Feed Dog 24
 - Sewing Corners 21
 - Flat Joining Seam** 47
 - Foot Control** 8
 - Free Hand System FHS** 9
 - Functions General**
 - clr (Clear) 30
 - Combi Mode 30
 - ESC (Close) 30, 123
 - OK 30
 - Pattern Begin 30
 - Scroll Down 30, 123
 - Scroll Up 30, 123
 - Single Mode 30
 - Functions Special for Sewing**
 - Alphabet Size 32
 - Balance 33
 - Continuous Reverse Sewing 33
 - Delete 32
 - Direct Entry Length or On-screen Button Measurement 32, 63
 - Manual Buttonhole 32, 63
 - Memory (File Drawers) 33
 - Mirror Image (left/right) 31
 - Mirror Image (up/down) 31
 - Multifunction Button 32
 - Pattern Extend 31
 - Pattern Repeat 32
 - Programming Buttonhole Length 32, 63
 - Reset Stitch Width and Stitch Length to the Basic Setting 31
 - Save 32
 - Securing Function 32
 - Security Program 33
 - Stitch Counter for Darning Program 31
 - Stitch Selection by Number 33
 - Upper Case/Lower Case 33
 - Functions and Displays for Embroidery** 123-128
 - Add Motif 125
 - Check 124
 - Color Motif Display 124, 127
 - Color Numbers 124
 - Delete 125
 - Edit 1 Screen 127
 - Embroidery Menu (OK) 125
 - Embroidery Sequence Control 127
 - Embroidery Time 124, 127
 - Hoop Display 127
 - Mirror Image (left/right) 126

| | | | | | |
|---|----------------|---|----------------|---|----------------|
| • Motif Center | 124 | • Drawer Content at a Glance | 89 | Q | |
| • Motif Size | 124, 127 | • Empty Stitch Altering Area | 88 | Quilt Stitches | 77-83 |
| • Move Motif | 126 | • In General | 87 | • Different Techniques | 78 |
| • New Motif | 125 | • Mirroring Entire Combination | 91 | • Freehand Quilting | 79 |
| • Rescale Motif Proportionally | 126 | • Opening Empty Drawer | 88-89 | • Hand-look Quilt Stitch | 79 |
| • Retrieve | 125 | • Opening Saved Combination | 89 | • Quilt Stitches Summary | 77 |
| • Return to Selection Menu | 123 | • Programming and Saving Stitch Combinations | 87-88 | Quilting with BSR | 80-83 |
| • Rotate Motif | 126 | Menu Selection | 26-27 | • Activating the BSR Sewing Function | 83 |
| • Save | 125 | Messages for Embroidery | 149-151 | • Application with Zig-zag or Straight Stitch | 83 |
| • Select Hoop | 124 | Messages for Sewing | 105-107 | • Beeper Deactivation/Activation | 82 |
| • Show Grid | 125 | Motif Colors | 139-140 | • BSR Function Deactivation | 83 |
| • Single/Multi Color Motif | 127 | • Embroidering Individual Color Sections | 140 | • BSR Mode 1 | 80 |
| • To Next Page – Edit 1 | 126 | • Embroidering Lettering in Multi Colors | 140 | • BSR Mode 2 | 80 |
| • To Next Page – Edit 2 | 125 | • Embroidering Motifs in One Color | 140 | • Deactivating the BSR Sewing Function | 83 |
| • Zoom | 125 | • Reallocating Motif Colors or Thread Brands | 139 | • In General | 80 |
| G | | N | | • Preparation | 81 |
| Glossary | 155-156 | Needle Summary | 18 | • Selecting Sound in the Setup Program | 82 |
| H | | Needle/Thread Combination | 17 | • Selecting Sound on the «BSR» Screen | 82 |
| Height Compensating Tool | 21 | Needle, Thread, Fabric | 16 | • Using Functions in the BSR Mode | 81 |
| Hems with Practical Stitches | 47 | Needle Threader | 12 | R | |
| Honeycomb Stitch Edges | 51 | O | | Ribbing with Overlock Seams | 48 |
| Hooping the Fabric | 115 | Optional Accessories | 111 | Safety Instructions | 1 |
| I | | P | | Saving Altered Settings Permanently | 24-25 |
| Important Embroidery Information | 117-118 | Personal Program | 84-86 | S | |
| Important Facts about Thread and Needles | 16 | • Altering Stitches | 86 | Saving Motifs | 141-145 |
| Inserting the Bobbin | 11 | • Deleting Stitches | 85 | • Deleting a Saved Motif | 144 |
| K | | • Programming Screen | 84 | • Deleting All Saved Motifs | 144-145 |
| Key to Signs | 3 | • Selecting Stitches | 85 | • Overwriting Motifs | 143 |
| M | | Piecing Stitch | 53 | • Saving to a Personal Design Stick | 142 |
| Main Category Buttons | 26-28 | Positioning Motif | 130-131 | • Saving to the Embroidery Computer | 141 |
| • Alphabets | 26 | Power Cable | 8 | Screen | 22 |
| • Buttonholes | 27 | Power Switch | 8 | Seam Guide | 9 |
| • Decorative Stitches | 26 | Practical Stitches | 34-53 | Securing Stitch | 39 |
| • Embroidery Mode/ Sewing Mode | 27, 128 | • Adjusting Individual Practical Stitches | 36 | Selecting Embroidery Motifs | 120 |
| • Personal Program | 27 | • Practical Stitches in the Combi Mode | 58 | Selecting Functions | 24 |
| • Practical Stitches | 26 | • Practical Stitch Seams | 36 | Setup-Program | 92-101 |
| • Quilt Stitches | 27 | • Practical Stitches Summary | 34-35 | • Display Messages and Audio Settings | 97-98 |
| • Setup Program | 28 | • Sewing Knit Fabric | 44 | • Display Settings | 93 |
| • Tutorial for Embroidery | 28 | Preparing the Embroidery Computer for Embroidery | 114 | • Embroidery Settings | 94-95 |
| Manual Darning | 43 | Presser Feet | 5 | • Enter Dealer Details | 99 |
| Memory Sewing | 87-91 | Presser Foot Indicator | 24 | • Menu | 92 |
| • Correcting a Stitch Combination | 90 | Presser Foot Lifter | 9 | • Monitoring Functions | 98 |
| • Deleting Drawer | 91 | Presser Foot Pressure | 19 | • Reset to Factory | 100-101 |
| | | Presser Foot Pressure Indicator | 19 | • Select Language | 98 |
| | | | | • Sewing Settings | 94 |
| | | | | • Text in Welcome Screen | 93 |
| | | | | • Touch (Screen Sensibility) | 96 |

| | | | |
|--|----------------|---|-----------|
| • Update | 99-100 | U _____ | |
| • Version Information | 99 | | |
| Sewing Light-CFL | 15 | Upper Thread Tension | 15 |
| Sewing on Elastic, | | V _____ | |
| Shirring Elastic/Cord | 52 | | |
| Slide-on Table | 9 | | |
| Spool Pin | | Vari Overlock Seam | 45 |
| • horizontal | 10, 11, 114 | | |
| • vertical | 13 | | |
| Starting to Embroider | 121-122 | W _____ | |
| • Attaching the Hoop | 121 | | |
| • Embroidery Motifs | 121 | Winding the Bobbin | 10 |
| • Embroidery Screen | 122 | | |
| • Selecting the Embroidery Hoop | 121 | Z _____ | |
| • Starting to Embroider with Foot Control | 122 | | |
| • Starting to Embroider with Start-Stop-Button | 122 | Zig-zag Stitch | 41 |
| Stitch Display | 23 | Zig-zag or Straight Stitch Eyelets | 76 |
| Stitch Plate | 20, 114 | Zipper | 49 |
| Stitch Selection | 23, 25 | | |
| Stitch Summary | 157-160 | | |
| Straight Stitch | 38 | | |
| Stretch- and Reinforced | | | |
| Overlock Seam | 46 | | |
| Super Stretch/Stretch Seam | 46 | | |

T _____

| | |
|--|-----------------|
| Temporary Altered Stitch Memory | 24, 37 |
| Thread Breakage | 147 |
| Thread Cutter | |
| • on Head Frame | 12 |
| • on Bobbin Winder | 10 |
| Thread Tension | 15, 114 |
| Thread, Needle, Fabric | 16 |
| Threading the Bobbin Thread | 114 |
| Threading the Upper Thread | 11, 114 |
| • Double Needle, Triple Needle | 14 |
| Triple Straight Stitch | 38 |
| Trouble Shooting | 104, 148 |
| Tutorial (only for Embroidery) | 146 |

Text

Herbert Stolz

Drawings

Müller-Melzer ID, Kreuzlingen

Design concept, Layout, DTP

Erika Vollenweider

Copyright

2005 Fritz Gegauf AG, Steckborn

