

bernette®  
for **BERNINA**+

# Model H79

EMBROIDERY MACHINE



## USER'S GUIDE

1  
C

1

0

1  
1

1

# Table of Contents

<b>Introduction .....</b>	<b>4</b>
Machine Parts .....	5
Display and Selection keys.....	6
Select Mode Arrows.....	7
Align Mode Arrows .....	7
Sewing Mode Arrows .....	7
Accessories .....	9
Optional Tools.....	10
<b>Operation.....</b>	<b>11</b>
Preparing to Embroider .....	11
Bobbin Winding .....	11
Installing the Bobbin.....	14
Threading the Machine .....	15
Thread the Needle Using the Needle Threader .....	16
Hooping .....	18
Using the Template .....	19
Attaching the Hoop to the Machine.....	23
Selecting a Design .....	24
Selecting a Design from Internal Memory .....	24
Selecting a Design from a Memory Card .....	25
Align Design .....	26
Sewing the Design.....	27
Trace the Design .....	27
Sew the Design.....	28
Thread Tension adjustment.....	30
Adjust Upper Thread Tension .....	30
Bobbin Tension Adjustment .....	31
Changing a Needle .....	33
Thread Breaks .....	35
Bobbin Thread Breaks .....	36
Removing Hoop from Machine.....	37
<b>Machine Cleaning and Oiling.....</b>	<b>37</b>
<b>Error Codes and Troubleshooting.....</b>	<b>39</b>
Error Codes .....	39
Troubleshooting .....	41

# bernette®

for **BERNINA**+

## Introduction

Welcome to the exciting and fun world of machine embroidery. Your Model H79 Embroidery Machine should give you many, many hours of fun and creativity. To familiarize yourself with the machine and how it works, it is recommended that you read through this manual. Your experience will be much more fun if you are familiar with the parts of the machine, what each one does and where to reference it again when you need more information.

**Use supplies recommended for use with embroidery.** Many products look the same but are not made especially for machine embroidery. Needles, threads and stabilizers are the main products you will want to keep on hand to make your embroidery experience easier. When you have the products handy and ready to use, you'll be more apt to use your machine more often. It will be great for gifts for family and friends. They'll be so impressed with your new talent when you make special gifts for them. Enhance your home décor with pillows, towels, even wall hangings and quilts. Use your machine for scrap-booking or card making. Your cards will be extra special! There is no limit to your creativity! Best of all, you'll have many hours of relaxation and fun!

Every effort has been made to make your Model H79 User's Guide accurate and as easy to understand as possible. Bernina, Inc. is not responsible for any errors or omissions.

# Know your machine

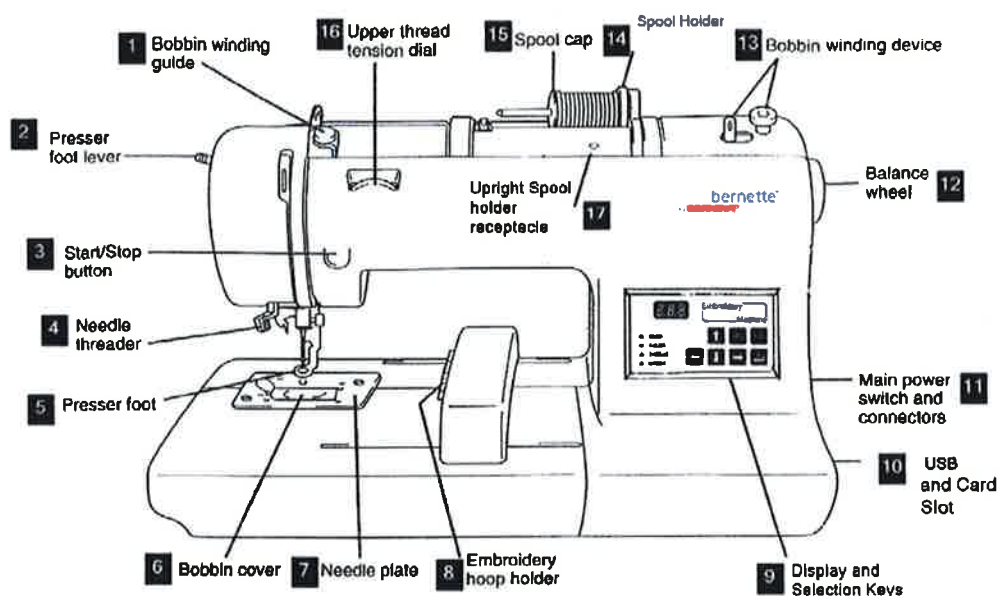

## Machine Parts





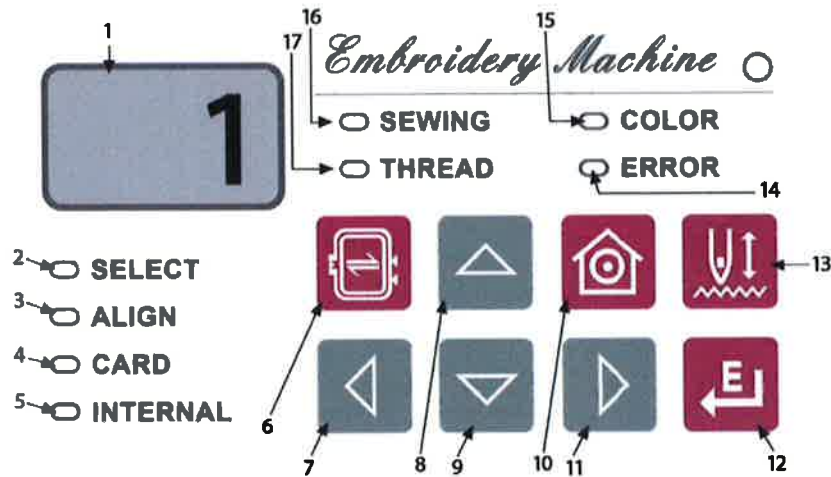

- |                               |                                      |
|-------------------------------|--------------------------------------|
| 1. Bobbin Winding Guide       | 10. USB Outlet and Card Slot         |
| 2. Presser Foot Lever         | 11. Main Power Switch and Connectors |
| 3. Start/Stop Button          | 12. Balance Wheel                    |
| 4. Needle Threader            | 13. Bobbin Winding Device            |
| 5. Presser Foot               | 14. Spool Holder                     |
| 6. Bobbin Cover               | 15. Spool Cap                        |
| 7. Needle Plate               | 16. Upper Thread Tension Dial        |
| 8. Embroidery Hoop Holder     | 17. Upright Spool Holder Receptacle  |
| 9. Display and Selection Keys |                                      |

# Display and Selection Keys







1. LED Screen – Displays functions
  - a. Design Number (## for design from Internal Memory or C## for design on Memory Card)
  - b. Color Number (i.e. c01, c02)
  - c. Error message codes—see Error codes, p. 39 - 40.
2. Select **SELECT** is lit when you are in the process of selecting a design. To make your selection press the  button.
3. Align **ALIGN** lights after you have selected a design. Design can now be embroidered or needle position moved in the hoop.
4. Card **CARD** lights to indicate you are accessing designs from a Memory Card.
5. Internal **INTERNAL** lights to indicate you are accessing designs from the Internal Memory of the machine.
6. Only available in align mode,  traces the four corners of the perimeter of the design in the hoop.
7. The arrow keys perform different functions depending on which mode has been accessed.



## Select Mode Arrows

-  Goes backward through the list of designs one design at a time.
-  Advances 10 designs at a time in the Internal Memory or Card Memory.
-  Goes backward 10 designs at a time in the Internal Memory or Card Memory.
-  Goes forward through the list one design at a time.









## Align Mode Arrows

-  Moves needle position closer to the left of the hoop.
-  Moves needle position closer to the top of the hoop (toward the back of the machine).
-  Moves needle position closer to the bottom of the hoop (toward the front of the machine).
-  Moves needle position closer to the right of the hoop.

## Sewing Mode Arrows

-  Moves backward through the design one stitch at a time.
-  Moves forward through the design one stitch at a time.

NOTE: The Up and Down arrows are not functional in Sewing Mode.

8. To center a selected design in the hoop press .
9. To enter or accept a design number shown in the LED window press .
10.  Toggles between Internal memory and a Memory Card. ## will be displayed on the LED when the Internal memory of the machine is accessed. C## signifies Card Memory has been accessed.
11. When lit,  **ERROR** indicates an error—see LED for error number. In some cases you may have to press the START/STOP button to see which error has occurred.
12. When lit, *Embroidery Machine*  indicates machine power is on.
13. When lit,  **COLOR** indicates a color change—see LED for color change number. This will be displayed as a lower case “c” followed by the number of the sequence of the color.
14. When lit,  **THREAD** indicates thread break.
15. When lit,  **SEWING** indicates machine is in sewing mode.



## Accessories

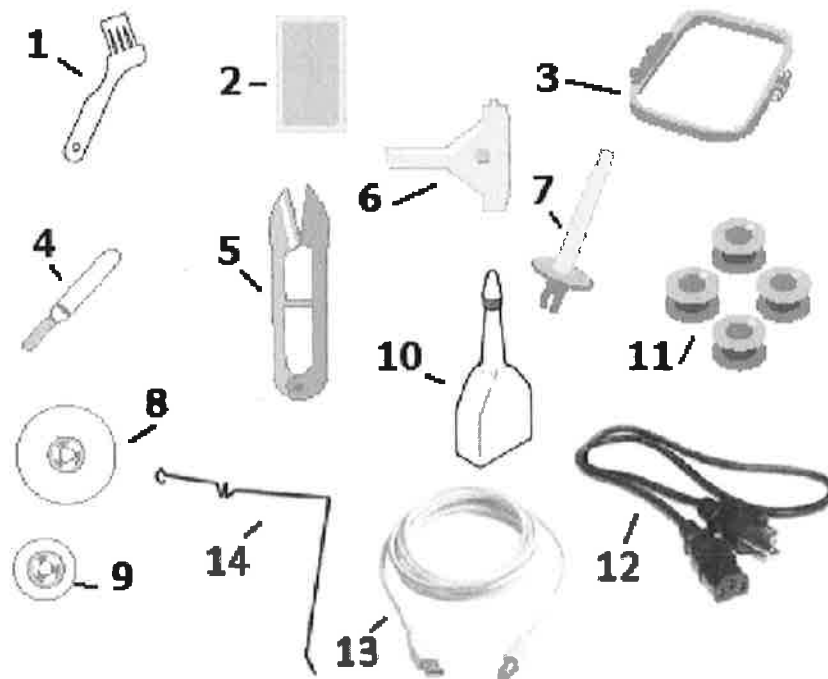

- |                           |                    |
|---------------------------|--------------------|
| 1. Cleaning Brush         | 8. Large Spool Cap |
| 2. Needle Pack            | 9. Small Spool Cap |
| 3. Hoop                   | 10. Oiler          |
| 4. Seam Ripper            | 11. Bobbins (4)    |
| 5. Thread Nippers         | 12. Power Cord     |
| 6. 3-Way Screwdriver Tool | 13. USB - AB Cable |
| 7. Upright Spool Holder   | 14. Thread Hook    |

## Optional Tools

To get the most from your Model H79 Embroidery Machine you will want to connect it to a Personal Computer. By using the eXplorations Lite software, you can add more designs to your collection as well as many other great features. The software gives you the ability to connect to the Internet and get more designs, ideas for projects, and new information about your machine. **Note:** *You do not need to be connected to the internet to use the software.*

With the eXplorations Lite software you can see your design before you sew it. You can size, rotate and mirror image the design as well as add lettering to personalize your projects. Changing colors of the design is simple. Using the eXplorations Lite software simply changes the color of the design on the screen and sees what the design will look like with the new colors, without having to sew out the design.

With the included Navigator, you can see the design sew on the computer screen as it is sewing on the machine. This is really helpful if you happen to want to skip part of the design. Simply stop the machine from the Navigator software, go forward through the design and then tell the machine to move to that point. If your machine has a problem you can also back up through the design using the Navigator. This can be a real time saver as well as being much easier than backing up with the arrow keys on the machine. (See Quick Start Guide for more information).

The eXplorations Lite software is very powerful, fun and easy to use. You can even get more from your machine by upgrading your eXplorations Lite software to eXplorations Basic software or eXplorations Galaxy. You can create new designs as well as edit pre-digitized designs plus have many more features at your fingertips.

# Operation

The operation of the Model H79 Embroidery Machine is simple. However, there are some guidelines to follow to make your embroidery experience a good one. To prepare to sew your first design, there are a few steps you'll need to take.

## Preparing to Embroider

### *Bobbin Winding*

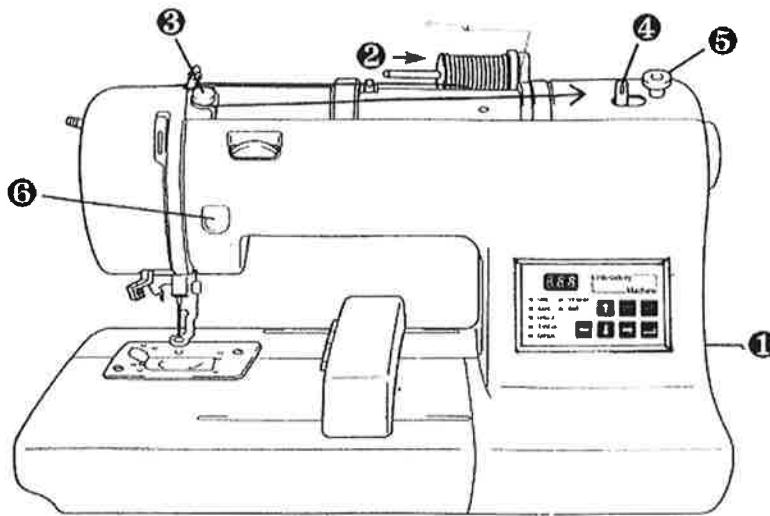

1. Connect the machine to the power supply and turn on the main power.

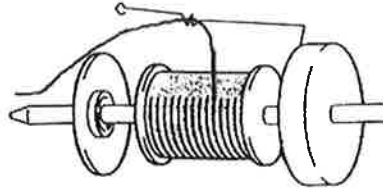

2

- Place the spool of thread, the suitable spool cap and the wire thread guide on spool pin. To attach the thread guide, clamp it onto the spool pin prior to sliding on the spool of thread. **NOTE:** Bobbin thread should always be used for normal embroidery. Bobbin thread is thread specifically made for embroidery and usually comes in white or black. An exception is when stand alone lace is embroidered. Use the same thread in the bobbin as is threaded on top when embroidering stand alone lace.

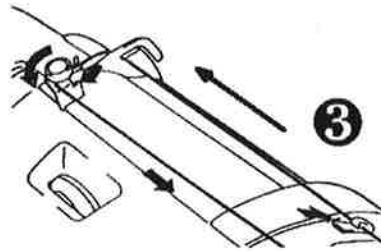

3

- Bring the thread through the guides and around the bobbin winder guide. (Follow thread path illustration on top of machine).

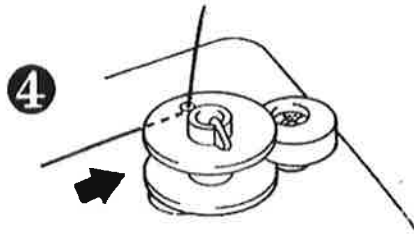

4

- Place an empty bobbin on the bobbin spindle. Put the thread through the small hole in the side of the bobbin from the inside. Match the groove of the bobbin with the spring on the shaft and press the bobbin onto the shaft. Push the bobbin winder shaft to the right. The word "bob" will be displayed in the LED screen. This tells you when the bobbin winder is engaged.

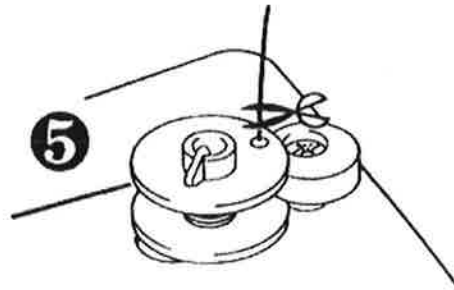

- 5.** Holding the thread end, press the START/STOP button. After the thread has wound a few times, press the START/STOP button to stop the machine. Trim thread from top of bobbin.



**6**

- 6.** Press START/STOP button to finish winding bobbin. Winding will stop automatically when the bobbin is full. Press the START/STOP button to stop the machine.

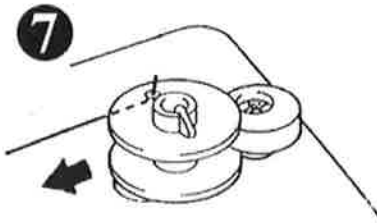

- 7.** Push the bobbin shaft to the left and remove the bobbin by lifting it up from the spindle. Clip the thread. NOTE: The machine will not embroider until the shaft is returned to the left.

- 8.** The winder speed can be increased and decreased by pushing either



buttons.

## Installing the Bobbin

To put the bobbin in the machine, follow these steps:

1

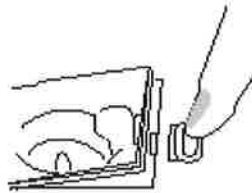

1. Slide open the bobbin cover by sliding the small black slide bar to the right. Remove the plastic cover. If the clear plastic cover does not flip up, slide it to the right a bit.

2

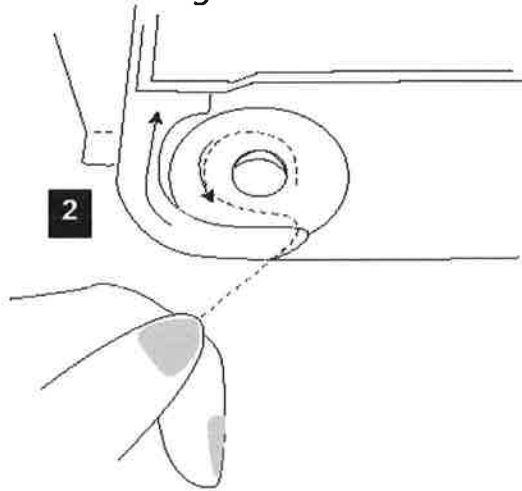

2. Insert the bobbin into the shuttle with the thread direction as noted in the etching under the bobbin cover.

3

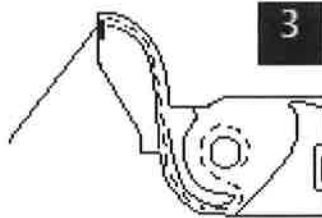

3. Guide the thread around the finger of the machine through the channel toward the back, and then pull the thread toward you to cut the thread end. The thread will be cut at the end of the channel and be ready for use.

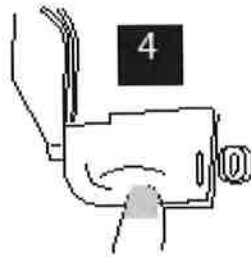

4. Replace the bobbin cover by placing the left end in place and pressing down lightly on the right end to snap in place.

**NOTE:** There is no need to pull up the lower thread, as it is done automatically.

**TIP:** It's a good idea to have several full bobbins before starting a new project.

### Threading the Machine

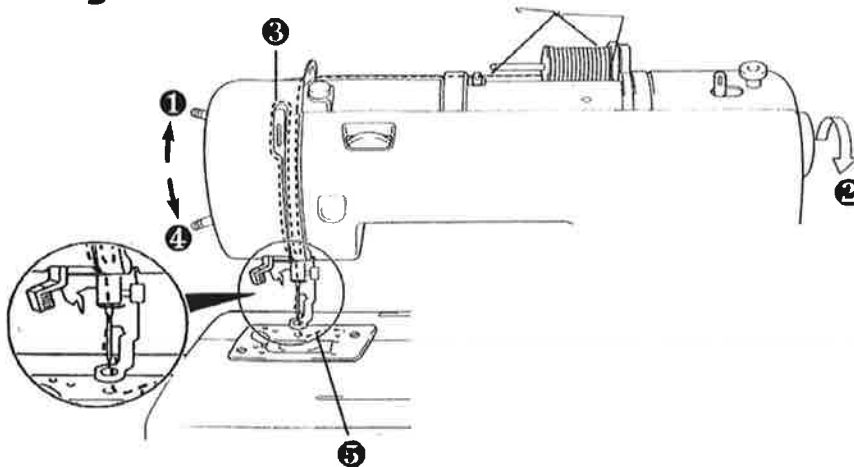

1. Raise the presser foot lever. *(If the presser foot is not raised, the upper thread cannot be threaded properly)*
2. Turn the balance wheel toward you to raise the needle to its highest position.
3. Guide the thread through the thread path, following the arrows and number sequence on the machine. (See dotted line in illustration).
4. Lower the presser foot.
5. Thread the needle using the needle threader or thread manually.

**CAUTION:** Always be sure to raise the presser foot before removing upper thread to prevent damage to the thread tension system.

## Thread the Needle Using the Needle Threader

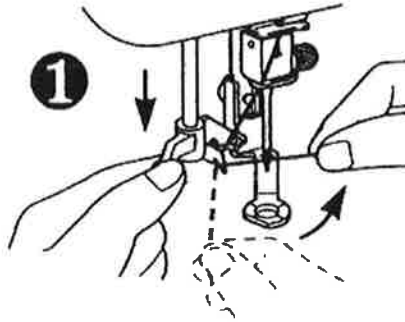

1. Lower the presser foot at this time. Lower the needle threader lever until it stops. Hook the thread into the threader guide and pull the thread to the right.

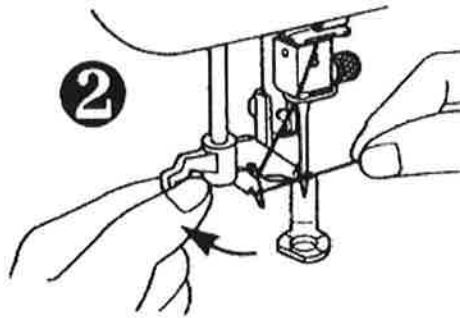

2. Push the needle threader lever toward the back to swing threader into place.

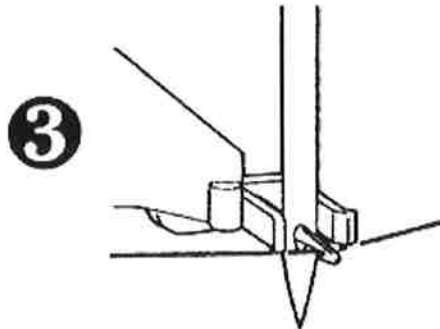

3. Check to be sure that the hook has passed through the eye of the needle and route the thread through the metal guides and under the hook. Pull the thread toward you and check that it is being held by the thread hook.



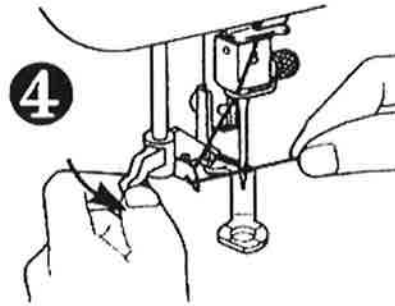

- 4.** While gently holding the thread, pull the needle threader lever forward.

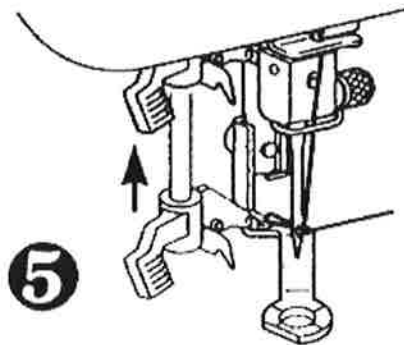

- 5.** Release the thread from the needle threader lever.

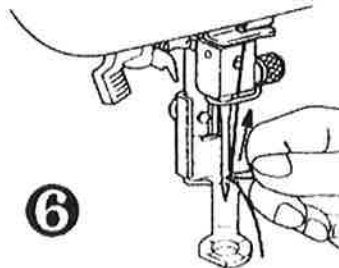

- 6.** Pull the upper thread through the needle eye from front to back toward the rear of the machine.

**NOTE:** Replace the needle often. Discard used needles, do not reuse.

## Hooping

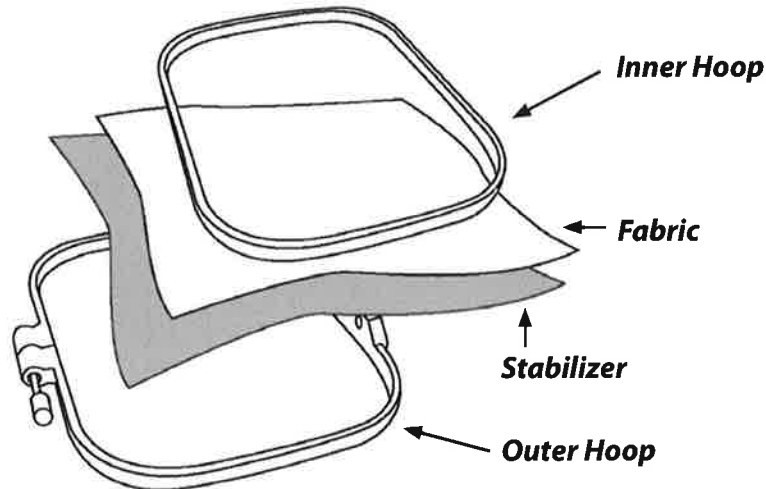

Make sure fabric, threads and stabilizer are compatible for laundering.

1. Place stabilizer on the wrong side of the fabric in the area to be embroidered.
2. Loosen the adjusting screw on the outer hoop, place the stabilizer (must be larger than the hoop) and fabric on top of the outer hoop with the right side of the fabric up. Always put stabilizer in the hoop with the fabric. Stabilizer must be larger than the hoop to adequately stabilize the fabric.
3. Place the inner hoop into the outer hoop to clamp the fabric and stabilizer. Fabric and stabilizer should be smooth in the hoop, but do not stretch or distort it. Smooth the fabric but do not stretch it. Push the inner hoop into the outer hoop. Clamp securely so that the edges of the outer hoop and inner hoop are even.
4. Firmly tighten the adjusting screw.

**NOTE:** Stabilizer provides body and control to fabric and aids in ensuring that stitches go where they should go. Stabilizers can be bonded fabric, liquid, or water soluble and can be sewn on, applied with spray adhesive or ironed on. Different blends of fabric react differently when water or heat is applied or when tearing or cutting stabilizer away from your finished design. Always have an assortment of stabilizer on hand to match with various fabrics. Always stitch a test design on actual fabric and stabilizer. Remove stabilizer gently and carefully to avoid distorting your design.

## Using the Template

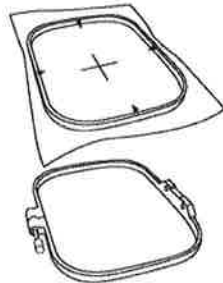

In order to hoop a garment straight, you may need to make some marks on the garment. Draw a + sign in the center where you want the design to be with chalk, a water soluble, air soluble or temporary marker that will wash out easily.

On the inner hoop there are four arrows, at the top and bottom and both sides. By lining up the marked center with the arrows at the top, bottom and sides, you will get a straight embroidery that is lined up with your markings.

To make this process much easier, a duplicatable template has been included in this manual on page 22.

You may print as many templates as you need. Print the template on clear transparency film, such as that used for overhead projectors, to create a reusable template. If you do not have a printer and want to make copies, take this entire book to the copy shop. This will inform the copy shop that you have permission to make copies of the template.

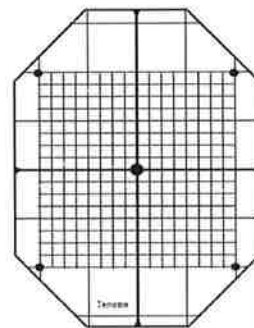

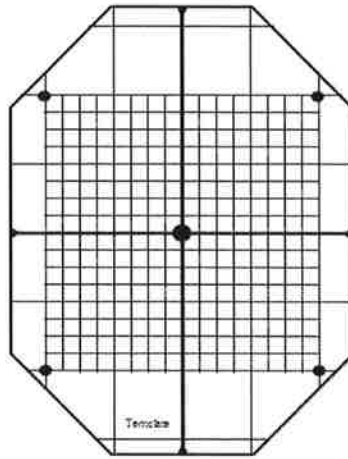

The template is ruled in 1 inch squares with the sewing field of the machine subdivided by  $\frac{1}{4}$ " squares. Cut out the template along the outside edge of the diamond shape. You may want to use a hole punch to punch out the circles. To get to the center circle, just barely fold the template so you can punch it. Or you can use a craft knife and make cross cuts at each circle. These will indicate the outside edge of the sewing field and the center where the design will start. You may also want to make a small notch in the top, bottom and both sides to denote the horizontal and vertical center lines. These horizontal and vertical center lines correspond with the arrows of the hoop.

**NOTE:** The sewing field of your Model H79 Embroidery Machine is 100mm x 100mm or 3.93 inches. The template is marked in inches, therefore the design will always fit within this area.

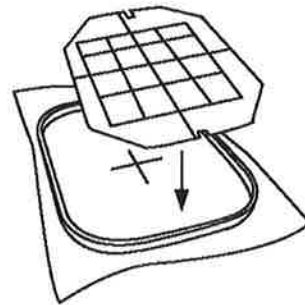
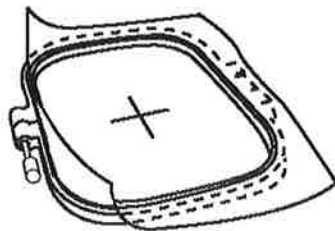

Mark the horizontal and vertical lines for the center of the design on the garment to be embroidered. Use the template to make sure the centers are lined up with the center of the sewing field.

You can use the template to mark the placement of the design on fabric or a garment.

1. Place the template over the section of the garment where you want the design to be. With an erasable marker, chalk, air dry marker, or water soluble marker, mark the four corner holes and the center. You may also want to mark the vertical and horizontal lines at the edge of the template.
2. Remove the hoop and connect the lines with your erasable marker.
3. Place the outer hoop under the garment and the stabilizer and place the inner hoop in the area you have marked for the placement of the design.
4. Place the template in the inner hoop. The small ledges of the inner hoop should hold the template in place. The lines on the template should line up with the arrows on the inner hoop.
5. Adjust the inner hoop on the garment to get it placed according to your markings. (This is why the transparency film is a good choice). When using a paper template, cut along the lines and fold back to see the markings you have made on the fabric.

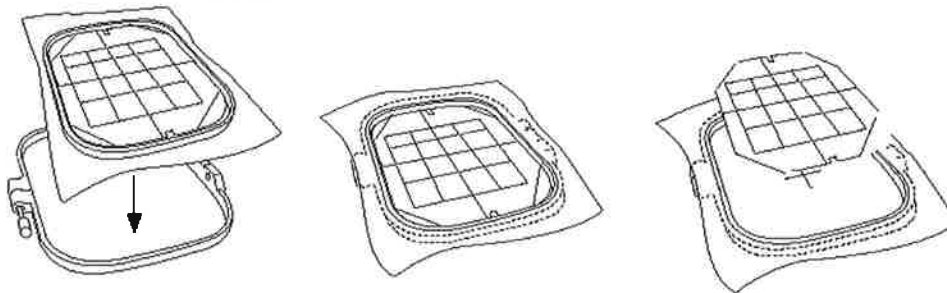

6. Once the inner hoop is lined up, adjust the outer hoop to fit. Press the inner hoop into the outer hoop and check the template again for proper placement.

Proceed with the hooping instructions on page 18.

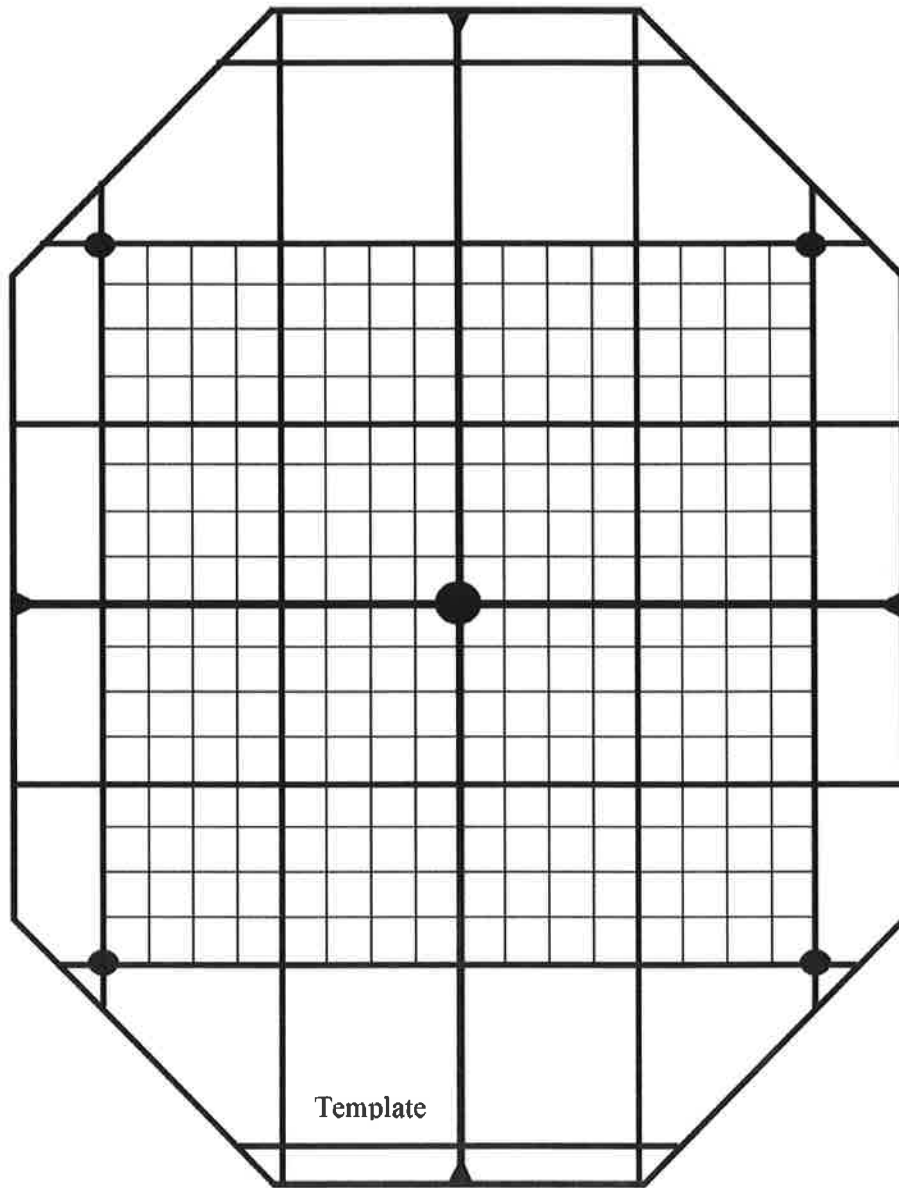

©Bernina of America, Inc. You have permission to make as many copies of this template as needed.

## Attaching the Hoop to the Machine

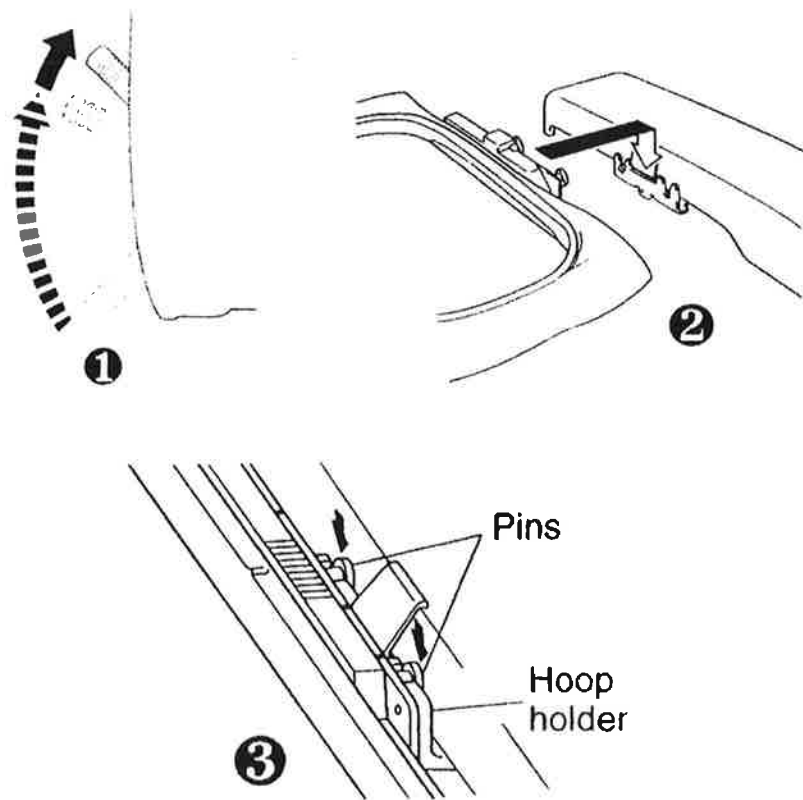

1. Raise the presser foot to its highest position.
2. Pass the embroidery hoop under the presser foot with the mounting pins on the right side and the fabric right side up. **NOTE:** It is easier to slide the embroidery hoop under the presser foot if you lift the presser foot all the way to its highest position with your left hand as you slide the hoop under the presser foot with your right hand.
3. Align the two pins on the embroidery hoop and firmly press straight down into the hoop holder until a soft click is heard. **NOTE:** Do not push too hard as you attach the hoop. Use caution so as not to move the hoop holder in any direction as you attach the hoop.

**NOTE:** Be sure to insert both pins. If only one pin is inserted, the result may be poor quality embroidery.

## Selecting a Design

In the Model H79 Embroidery Machine you have Internal Memory as well as Card Memory. Designs can be accessed from both places.

### Selecting a Design from Internal Memory

In order to use the Internal Memory of the Model H79 Embroidery Machine to its fullest, you must have it connected to a Personal Computer with the software installed. This allows you to save designs to the Internal Memory of the machine. The Internal Memory will hold up to 99 designs or one million stitches, whichever comes first. You must use the eXplorations Lite software and the Navigator to view, save or delete designs in the internal memory.

To select a design from Internal Memory you must use the  button on the keypad. This button toggles back and forth from Internal Memory (designs that show as ## in the LED screen) to Card Memory (designs that show as C## in the LED screen). When you have Internal Memory selected, the light next to "Internal" will be illuminated.

- SELECT
- ALIGN
- CARD
- INTERNAL

To move through the selections in the Internal Memory you will use the arrow buttons on the keypad.

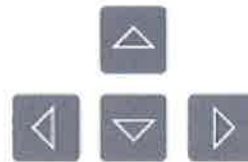

The Right Arrow button  will take you forward through the list of designs (higher numbers) one design at a time.

The Left Arrow button  will take you backward through the list (lower numbers) one design at a time.

The Up Arrow button  will advance 10 designs at a time.

The Down Arrow button  will take you backwards 10 designs at a time.



Once you have the design you wish to sew selected, press the Enter button .

## Selecting a Design from a Memory Card

Card Memory (designs that show as C## in the LED screen) are designs that are on a pre-programmed Memory Card. The search features are the same as above for Internal Memory.

To select a design from a Memory Card you must first have a card inserted.

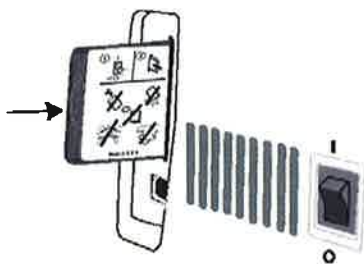

To insert the Memory Card into the machine simply insert the card in the card slot until it softly clicks. It should go in easily. Do not force the card. If it does not go in easily, you may have the card reversed. Forcing the card into the slot could bend the connector pins inside the machine.

Use the  button on the keypad to access the Memory Card designs. This button toggles back and forth from Internal Memory (designs that show as ## in the LED screen) to Card Memory (designs that show as C## in the LED screen). When you have a Memory Card selected, the light next to "Card" will be illuminated.

- SELECT
- ALIGN
- CARD
- INTERNAL

When you find the design you want to select, press the Enter button



## Align Design

Designs, in most cases, start and stop at the center of the design. The Model H79 Embroidery Machine is programmed to start and stop in the center unless you specify otherwise in eXplorations Lite software. When hooping your fabric to be embroidered you will need to mark where you want the center of the design to start. If you don't get the fabric centered exactly in the hoop, you can reposition the needle in the hoop to some degree depending on the size of the design.

Once you have selected your design, you will see that the illumination has changed on the keypad from Select to Align allowing you to use the arrow keys to move the needle position of the start of the design around in the hoop. You must have the presser foot lever in the upper position to move the needle position. (E15 will appear in the LED screen if the presser foot lever is in the lower position. Raise the presser foot and Press the arrow button again).

- SELECT
- ALIGN
- CARD
- INTERNAL



To center the design in the center of the hoop, use the Home button . This positions the hoop so that the needle is in the center of the hoop.

To move the needle position to the left in the hoop, use the Left Arrow . If you try to move too far, you will get an error (E25). This means that the machine cannot sew the design any further to the left. If the design needs to start closer to the left, you will need to re-hoop the fabric.

To move the needle position to the right in the hoop, use the Right Arrow . If you try to move too far, you will get an error (E26). This means that the machine cannot sew the designs any further to the right. If the design needs to start closer to the right, you will need to re-hoop the fabric.

To move the needle position to the bottom of the hoop, use the Down Arrow . If you try to move too far, you will get an error (E27). This means that the machine cannot sew the design any further to the bottom. If the design needs to start closer to the bottom, you will need to re-hoop the fabric.

To move the needle position to the top of the hoop, use the Up Arrow . If you try to move too far, you will get an error (E28). This means that the machine cannot sew the design any further to the top. If the design needs to start closer to the top, you will need to re-hoop the fabric.

## Sewing the Design

### *Trace the Design*

After selecting the design you wish to sew, it is always advisable to trace the design. Make sure you are in the Align Mode by checking to see that Align is illuminated.

- |  |    |   |
|--|----|---|
| <input type="radio"/> SELECT           |    | <input type="radio"/> SELECT              |
| <input checked="" type="radio"/> ALIGN |    | <input checked="" type="radio"/> ALIGN    |
| <input checked="" type="radio"/> CARD  |    | <input type="radio"/> CARD                |
| <input type="radio"/> INTERNAL         | OR | <input checked="" type="radio"/> INTERNAL |

Make sure the presser foot is in the up position. Press the Trace button . The hoop will begin to move to all four corners of the outer perimeter of the design and then back to the center. You can still reposition the needle if necessary. If you move the hoop, you should trace the design again.

## Sew the Design

Now that you have the hoop positioned where you want the design to start you are ready to sew the design.

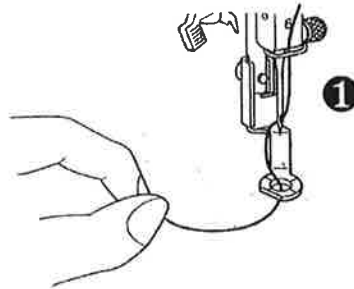

1. After threading the needle, place the thread through the hole in the presser foot from top to bottom and gently pull the end of the thread (See figure 1 above).

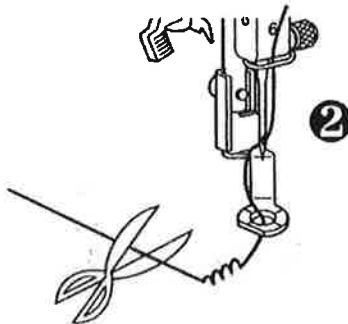

2. Lower the presser foot and hold the thread in your left hand. If you do not hold the thread taut, you may get a thread break error (E13). Press the START/STOP button to start the machine. After sewing 5-6 stitches, stop the machine by pressing the START/STOP button and raise the presser foot again. Clip the beginning thread tail close to the fabric. Do this when starting each color.

**TIP:** Make sure you are trimming the thread tail and not the sewing thread closest to the needle.

3. After trimming, lower the presser foot and press the START/STOP button again to start the machine. The machine will stop when it completes all the stitching with this thread color. During the sewing process, the display will read =## signifying the percentage of completion of the design. For example, =22 is displayed in the LED means that the design is 22% complete.
4. When the color is complete, the LED screen will display c## (c02 for the second color in the design, c03 for third color in the design, etc). depending on the sequence of the color. This lets you know which color to change to according to the code sheet of the design.
5. To change the color of the upper thread, raise the presser foot and clip the upper thread close to the embroidery AND at the thread spool. Pull the upper thread from the needle to remove and discard it.
6. Thread the machine with the new color.
7. Lower the presser foot. While holding the thread tail, press START/STOP to sew the next color section.
8. Repeat until the design is completed. The LED will show 100 to represent 100% completion when the design is complete.

## Thread Tension Adjustment

Thread tension can be adjusted from either the top thread tension adjustment or the bobbin case screw adjustment. If you see bobbin thread on top, you may need to adjust the tension. However, before you adjust anything, check to see if the thread may be caught and not feeding properly. Next, check to see if the machine is threaded correctly. Change the needle. This could also affect the tension. Adjust the tension only if these suggestions do not correct the problem.

### ***Adjust Upper Thread Tension***

When making tension adjustments, always start with the top thread. If bobbin thread is showing on the top of the design, this means that the tension on the top thread is too tight or the bobbin adjustment is too loose. To loosen the top thread tension, rotate the Thread Tension knob to the left (to a lower number).

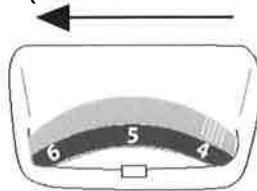

If the stitches are not setting properly in the fabric or if loops appear, you may need to adjust the tension so that it is tighter. First check to see if the machine is threaded correctly before making any adjustments. If threading is correct, turn the Thread Tension knob to the right (to a higher number).

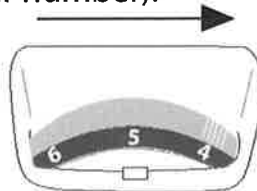

The standard position of the tension should be between 4 and 6 as noted in the dark area of the Thread Tension knob.

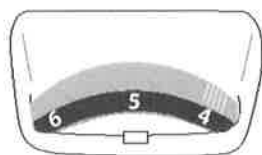

To check to see if your machine has proper tension, look at the wrong side of the embroidery. Proper tension should be where the bobbin thread is covering the middle 3rd of the back of the embroidery. The image below shows different tensions from the wrong side of the embroidery stitches. You should see approximately 1/3 of the top thread on either side of the bobbin thread. The column on the far left shows proper bobbin and top thread tension. The column in the middle shows the bobbin tension too tight and/or the top thread too loose. Sometimes the bobbin thread is barely showing. If this happens it is very likely that the bobbin thread may break during wear and tear and the embroidery will come loose. The column on the right shows the bobbin tension too loose and/or the top tension too tight. The bobbin thread could be showing on the right side of the embroidery in some places and it is very likely that the stitches could become loose during wearing.

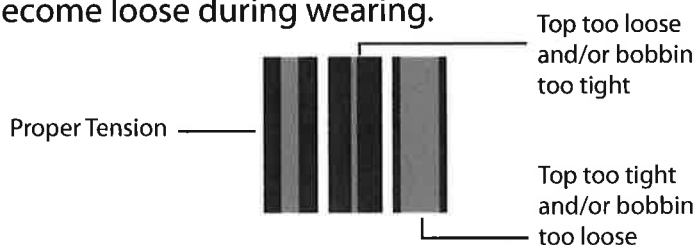

### **Bobbin Tension Adjustment**

Adjusting the bobbin is a little more difficult. Only adjust the bobbin if you cannot achieve a proper tension with the adjustments to the top thread tension.

Remove the bobbin cover from the machine.

Using the 3-Way Screwdriver Tool provided in the accessory pouch, remove the two screws from the stitch plate and lift up the stitch plate.

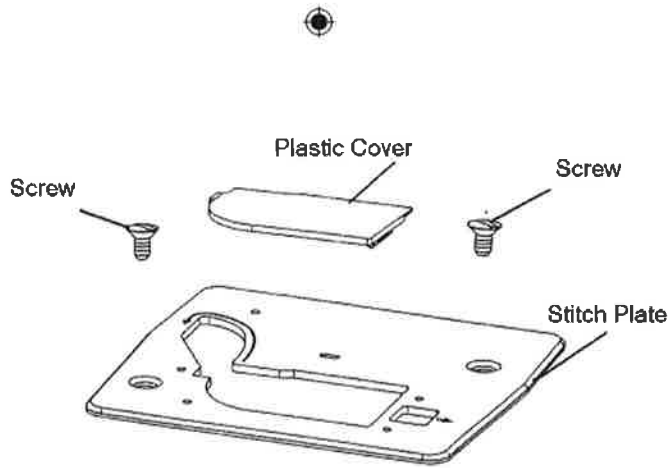

Remove the bobbin and the bobbin case.

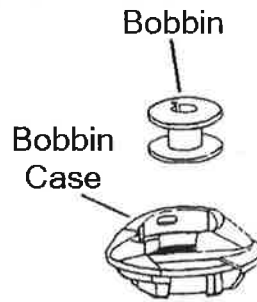

If too much bobbin thread is showing on top of the embroidery, the bobbin tension needs to be tightened. On the side of the bobbin case there is a tiny screw (bobbin tension adjustment screw).

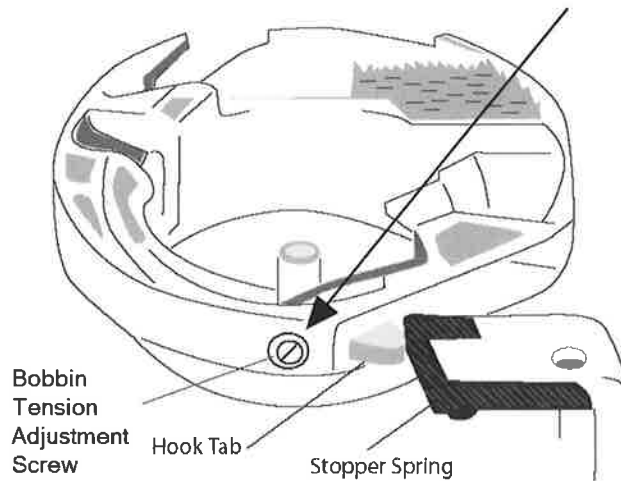

Using the small end of the 3-way screwdriver tool, rotate the screw  $\frac{1}{4}$  turn to the right to tighten the tension.



If not enough bobbin thread is showing on the wrong side of the embroidery, turn the screw  $\frac{1}{4}$  turn to the left to loosen the tension. Replace the bobbin case. The Hook Tab should be to the left of the Hook with the fuzzy part under the bar. Replace the stitch plate. Make sure the screws are in as far as they will go. Tighten hand tight. Do not use any mechanical devices to screw in the screws.

Put the bobbin back in the bobbin case according to the image on the bobbin case and replace the plastic cover onto the stitch plate.

Test the embroidery again to see if further adjustments are needed. Never adjust more than  $\frac{1}{4}$  turn at a time.

## Changing a Needle

If you break a needle while sewing, stop the machine immediately. Change the needle according to the instructions below.

Use embroidery needles with your Model H79 Embroidery Machine. Embroidery needles are made for the higher speeds of embroidery machines. Regular sewing needles are not recommended, but will not damage your machine. We recommend Organ Brand embroidery needles, which are included with the machine.

Changing the needle should also be done at regular intervals to keep your Model H79 Embroidery Machine running well and your embroidery looking good. A good time to change the needle is when you start a new project. Needles should be changed at intervals no longer than four to six hours of sewing time. (You can figure your sewing time by dividing the number of stitches by 500. This will give you the number of approximate minutes it will take the machine to sew out the design, i.e. 5000 stitches divided by 500 is 10. The design will take approximately 10 minutes to sew out).

To change the needle in your Model H79 Embroidery Machine, you will need the 3-way screwdriver tool that came with your machine or a short flat blade screwdriver.

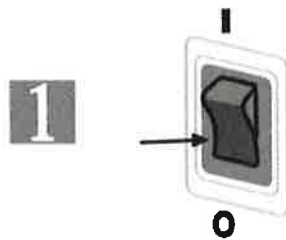

1. It is a good idea to turn off the power if you are not in the middle of an embroidery design. If you have to change the needle in the middle of a design, be very careful not to push the START/STOP button during the process of changing the needle.

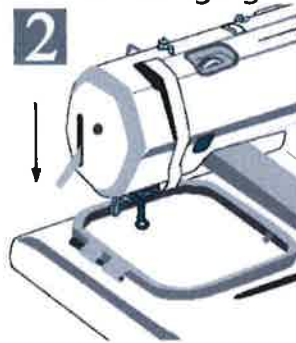

2. Lower the presser foot to its lowest position and raise the needle to its highest position by turning the balance wheel toward you. This will facilitate the removal and replacement of the needle.

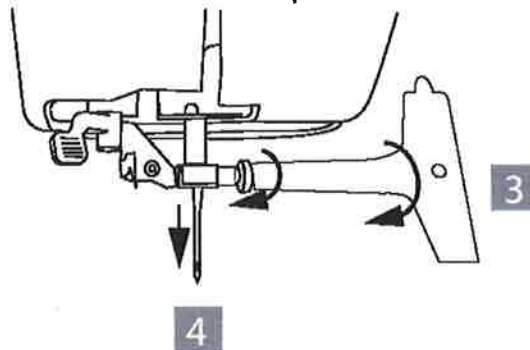

3. With the 3- way screwdriver tool provided in the accessory kit, loosen the needle screw (counterclockwise) until the needle can be removed from the machine.

- Remove the needle by pulling straight down. Once the needle is free from the machine, discard it. Do not reuse old needles.

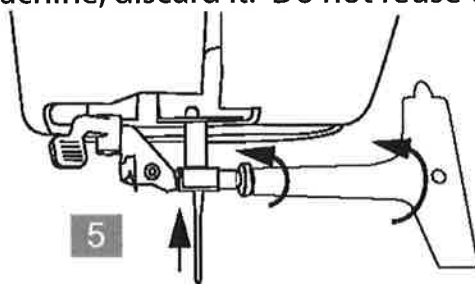



- Insert a new needle into the machine with the flat side of the needle away from you and toward the back of the machine. Push the needle up as far as it will go. Tighten the screw as tight as you can (clockwise).

**NOTE:** Use only Embroidery needles. These are made for the high speeds of embroidery machines. Use sharp point needles for woven fabrics and ball point needles for knit fabrics.

**TIP:** Titanium needles will last much longer than standard steel needles which make them a good value.

## Thread Breaks

In the event of a thread break, the machine will stop. When the machine stops, you may have to push the START/STOP key to see which error has occurred. Check the needle to see if the thread is broken. If the thread is not broken at the needle, the thread has either gotten out of one of the guides or is caught on something. If the thread is broken, re-thread the machine and the needle.

Using the Left Arrow key  on the key pad, you can back up through the design until you reach the point at which the thread broke. By pressing the  key, it will start backing up 1 stitch at a time. If you need to back up quite a bit hold the button down, it will then start backing up in larger increments. If you only need to back up a few stitches, press the  key and then lift your finger and press it again. This will allow you to keep backing up 1 stitch at a time. Press the START/STOP key to restart the embroidery. Remember to hold on to the thread to keep the thread taut until five or six

Model H79

stitches are sewn. Stop the machine and trim the thread tail close to the fabric.

When the machine is backed up to the point of the thread break, the display shows the percent that has been completed. When START/STOP is pushed, it will change to the percent of completion where the thread break occurred.

Thread breaks happen occasionally but are not necessarily a warning sign that something is wrong unless they are frequent. If thread breaks occur very often, change the needle. Many times the needle can become dull or have a spur or just be a tiny bit bent. Replacing the needle is the easiest fix.

If changing the needle does not eliminate the frequent thread breaks there may be a small piece of thread in the bobbin case. Clean the bobbin case thoroughly using a small soft brush.

Old sewing thread is not recommended for use with your machine. Use good quality embroidery thread such as Isacord or Poly Sheen. Some specialty threads will work with your machine but may have frequent thread breaks.

## Bobbin Thread Breaks

Rarely does the bobbin thread break. But if it does break, carefully remove the hoop from the machine. Check the bobbin to see if there is thread on the bobbin. An empty bobbin can register a thread break. Replace with a filled bobbin.

In the unlikely event that the bobbin thread is broken, remove the bobbin and reinsert it or put in a full bobbin following the diagram on the bobbin case.

## Removing Hoop from Machine

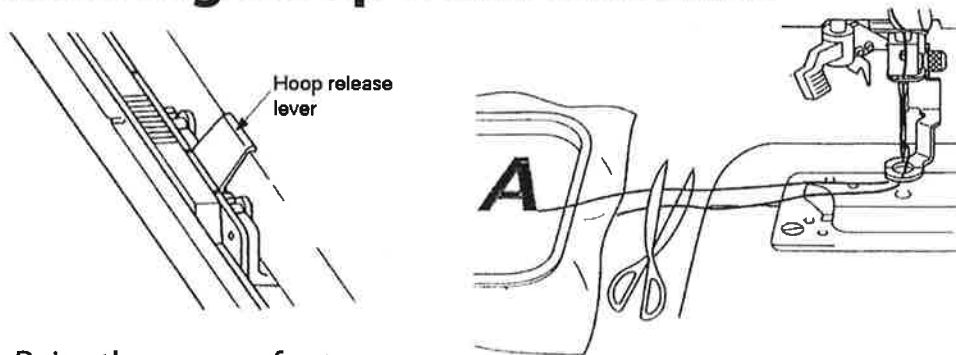

1. Raise the presser foot.
2. Remove the embroidery hoop from the machine by gently pushing the Hoop release lever to the right.
3. Raise the presser foot to its highest position to slide the hoop under it to remove it from the machine.
4. When cutting the lower thread, leave about 10 cm. (4 inches) of bobbin thread outside the needle hole in the needle plate. (Cutting off the thread at the edge of the machine should be adequate).

## Machine Cleaning and Oiling

**\*\*Always unplug machine prior to performing any maintenance\*\***

Machine cleaning, oiling and maintenance is very important to ensure a long lasting, enjoyable machine. Keep dirt and dust away from the machine as much as possible. Small bits of thread can cause huge problems. Keep the bobbin case free of dust and thread pieces. Remove the needle plate and bobbin case and clean entire area (pg. 32).

To keep your machine running smoothly you will want to do regular cleaning followed by oiling (use sewing machine oil only). The following graphic shows the points at which you should add one drop of oil each time you clean your machine. A clean machine is a happy machine. And a well oiled machine is a well running machine. Approximately once a week, or after approximately 20 hours of sewing you should take the machine head cover off by loosening the screw just to the right of the presser foot lifter. Take off the plastic cover to expose the inner workings of the machine.

Model H79

Clean the areas shown on the diagram with a clean soft brush.  
Follow by adding one drop of oil at each location on the diagram.

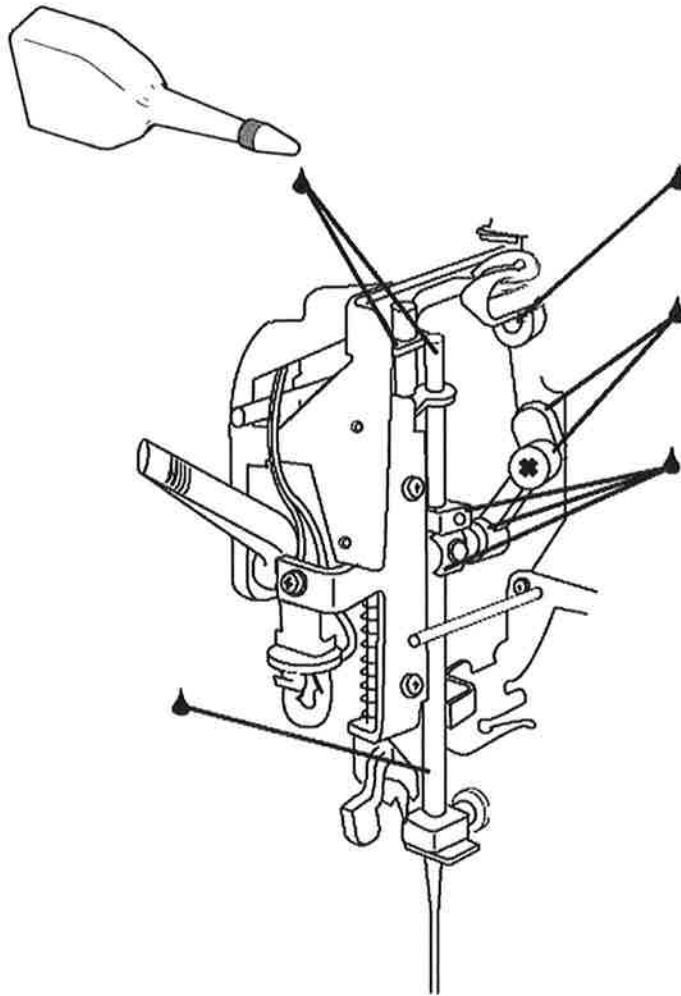

Replace the plastic cover and the screw. Sew out a design on a scrap piece of fabric to test the machine and work in the oil. This will also remove any excess oil.

# Error Codes and Troubleshooting

## Error Codes

Error	Problem	Solution
<b>11</b>	Needle is in the fabric and the hoop cannot move.	Turn the Balance Wheel until the needle is at its highest point.
<b>12</b>	Card was removed.	Do not remove the card while the machine is on.
<b>13</b>	Upper thread broken.	Re-thread the needle or check to see if the thread is not in all the tensioners. If this happens at the beginning of the design, hold the thread taut when you press the START/STOP button.
<b>14</b>	Presser foot needs to be lowered.	Lower the presser foot with the presser foot lever
<b>15</b>	Presser foot needs to be up.	Raise the presser foot with the presser foot lever.
<b>16</b>	Bobbin Winder is engaged.	Push the Bobbin winder to the left to disengage it.
<b>22 &amp; 23</b>	Design is too large to sew.	Choose another design or make the design smaller using the software.
<b>25</b>	-X limit reached.	Start design in center of hoop and trace to make sure design will fit and restart design.
<b>bob</b>	Bobbin winder engaged.	Move bobbin winder to the left to disengage it.

continued on next page

<b>Error</b>	<b>Problem</b>	<b>Solution</b>
<b>26</b>	+X limit reached.	Start design in center of hoop and trace to make sure design will fit and restart design.
<b>27</b>	-Y limit reached.	Start design in center of hoop and trace to make sure design will fit and restart design.
<b>28</b>	+Y limit reached.	Start design in center of hoop and trace to make sure design will fit and restart design.
<b>36</b>	No design selected.	Select a design.
<b>40</b>	The main motor has stalled.	Check for obstructions or thread nests.
<b>53</b>	Not enough available free space.	Delete some designs in the internal memory using Navigator.



## Troubleshooting

If you are having difficulty with a certain part of the embroidery process, review that section of the manual to make sure you are performing the task properly. Some common problems that you might encounter are:

Common Problem	Possible Cause and Solution
Thread breaks.	<ol style="list-style-type: none"> <li>1. Check the thread to see if it is properly threaded in all the guides.</li> <li>2. Make sure you are using embroidery thread recommended by the manufacturer of the machine. (Isacord Polyester or Poly Sheen)</li> <li>3. Change the needle.</li> <li>4. Check to see if the bobbin thread has run out.</li> <li>5. Check the needle to see that it has been inserted properly.</li> </ol>
Bobbin thread breaks.	<ol style="list-style-type: none"> <li>1. Check to see if the correct bobbin thread is being used. Use bobbin thread recommended by the manufacturer. Use spun Poly or continuous filament bobbin thread.</li> <li>2. Bobbin thread has not been wound properly. Review the bobbin winding section of the manual.</li> <li>3. Bobbin has not been inserted properly. Take out the bobbin and reinsert it following the guidelines in the manual and the image on the stitch plate.</li> </ol>
Puckered fabric around embroidery design.	<ol style="list-style-type: none"> <li>1. Review the Hooping section of the manual to see if you are following all the instructions.</li> <li>2. Improper stabilizer used.</li> <li>3. Improper thread tension.</li> <li>4. Screw on hoop was not tight enough to hold fabric.</li> </ol>

continued on next page

Common Problem	Possible Cause and Solution
Bobbin thread is showing on the top of the design.	<ol style="list-style-type: none"> <li>1. Check the top thread to see if it has gotten caught and not feeding properly.</li> <li>2. Re-thread the machine and pull the thread with one hand at the spool and one at the needle at the same time to make sure all the guides have been threaded properly.</li> <li>3. Adjust tension on the bobbin case by tightening the screw one quarter turn at a time. (See the section on adjusting the bobbin tension).</li> </ol>
Thread loops on top.	<ol style="list-style-type: none"> <li>1. Adjust the tension tighter on the top thread.</li> <li>2. Change the needle.</li> <li>3. Re-thread the machine and pull the thread with one hand at the spool and one at the needle at the same time to make sure all the guides have been threaded properly.</li> </ol>
Thread break errors when starting a new color.	<ol style="list-style-type: none"> <li>1. Hold onto the thread tail as you start the machine. The thread needs to be taut to avoid registering a thread break.</li> </ol>
Outline of design is off.	<ol style="list-style-type: none"> <li>1. Make sure you have attached the hoop to the machine properly. If the hoop is not attached at both pins, the design could be distorted.</li> <li>2. Follow all hooping instructions in the Hooping section of the manual.</li> <li>3. The inner hoop may not have been pushed all the way into the outer hoop.</li> </ol>
Skipped stitches or machine not sewing.	<ol style="list-style-type: none"> <li>1. Probably a bent or improperly inserted needle. Make sure the needle isn't bent by laying it on a flat surface with the flat side down and make sure it is straight.</li> <li>2. Needle may have been inserted backwards. Take the needle out and reinsert it.</li> <li>3. Needle may be dull. Replace with a new needle.</li> </ol>

